

Agilent Technologies Pulsed Measurements with the Agilent 8720ES and 8753ES Network Analyzers

Product Note

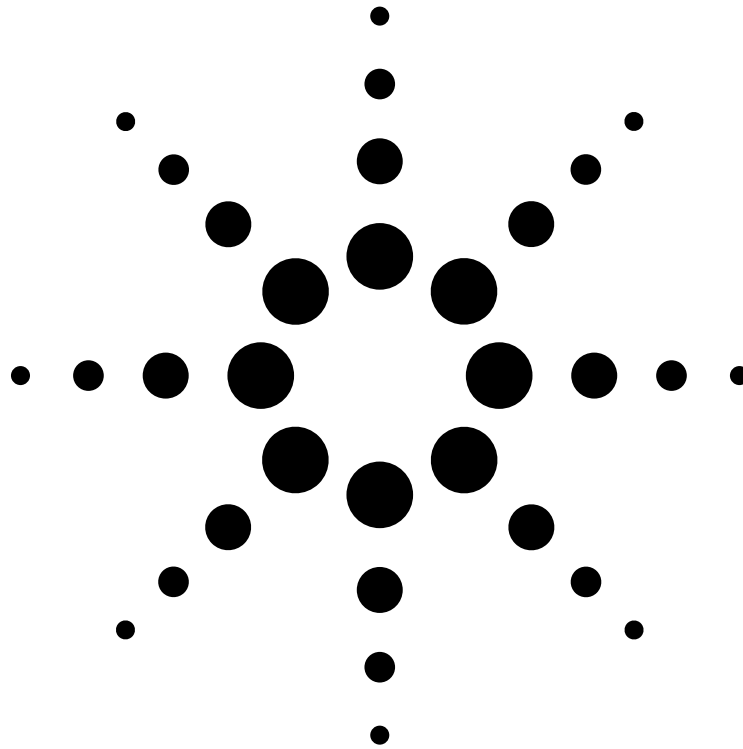

Agilent Technologies
Innovating the HP Way

Introduction

High-performance vector network analyzers are used to characterize the frequency responses of various RF and microwave components. While most network analyzers are used to measure continuous signals, some users have a need to pulse the RF signal on and off. The need for pulsed signals arises for various reasons. It might be because the total power input to the device under test must be limited to prevent overheating, or because the component will only operate under pulsed conditions, or because the component behaves differently in response to pulses than it does to steady state inputs. Whatever the reason, pulsed RF creates a unique set of conditions that must be addressed in order to produce reliable measurement results.

It is commonly presumed that only network analyzers such as the Agilent 8510C or the 85108A that incorporate sophisticated timing circuits, dual reference channels, and wide IF bandwidths are suitable for measurements of pulsed systems. However, the aim of this product note is to show that under certain conditions, network analyzers such as the 8720ES and 8753ES can produce good results at a much lower cost. The principles in this product note apply to either model, and to some earlier models as well; for brevity we will refer only to the 8720ES throughout the rest of this product note.

In general, for a standard network analyzer to be able to make pulsed measurements, there are three conditions that must be met. The first condition is that the RF source must be externally modulated, since a standard network analyzer lacks any modulating circuitry. The second condition is that if the pulse is a single or randomly timed pulse, it must exceed a width of 400 microseconds. Also for this case, the user must supply external triggering circuitry with variable delay between the trigger signal and the RF pulse. The third condition is that if the RF signal is a continuous pulse train, the minimum pulse width must exceed 500 nanoseconds and the pulse repetition frequency must be 20 Hz or greater. The reasons for these constraints will be explained later. (Note: the techniques described in this product note cannot determine the impulse response of a device.)

Measurement theory

In general two types of pulse measurements may be made: Those with a pulse width greater than the network analyzer's response time, and those with a pulse width less than the network analyzer's response time. These will be designated as low PRF measurements and high PRF measurements, where PRF stands for pulse repetition frequency. Each of these conditions must be treated as a separate case, since each has its own unique requirements.

Low PRF measurements

Every network analyzer has a sample response time that depends upon fixed internal characteristics such as CPU speed, and variable characteristics such as the IF bandwidth of the system. It is characteristic of the digital filtering used in the 8720E and 8753E that wide IF bandwidths result in faster sample times, while narrow IF bandwidths improve dynamic range.

If a given pulse is wider than the minimum analyzer response time, and the proper timing is established between the external signal that triggers the analyzer and the signal that triggers the pulse itself, we can be guaranteed that a valid measurement point will result. This is because during the entire time the analyzer is sampling, the RF signal is on. We define this condition to be a low PRF measurement. Because the 8720ES triggers on a falling edge, the external trigger signal must often be inverted to generate this edge before the RF pulse appears. Also, it should be noted that the analyzer does not begin sampling until some time has elapsed after the trigger signal has been received. Table 1 shows the relationship between the IF bandwidth and the minimum pulse width and delay for the 8720ES when operating in the low PRF mode. Note that the trigger delay varies slightly between instruments.

Table 1. Using external triggering for low PRF

IF Bandwidth	Minimum pulse width for a single measurement point (milliseconds)	Trigger delay (typical) ¹ (milliseconds)
6000 Hz	0.40	0.70
3700 Hz	0.53	0.70
3000 Hz	0.60	0.70
1000 Hz	1.10	0.70
300 Hz	3.20	0.70
100 Hz	8.90	0.70
30 Hz	32.0	0.70
10 Hz	120	0.70

1. The digital IF takes several ADC samples before it starts taking the "real" data for the point. It uses these samples to compute the IF gain setting; it does this even if IF gain is controlled manually in the service menu. The most common value for this delay is 0.70 milliseconds, but some instruments exhibit delays of 0.81 or 1.00 milliseconds. There is no way to tell which is which, except by experiment. Once the trigger delay is determined, it is constant within a given instrument (i.e. there is no dependence on settings). The user is always safe by presuming a shorter delay than given in the table, however the minimum pulse width may have to be increased correspondingly to compensate for any difference between the presumed delay time and the actual delay time.

Two types of low PRF measurements are possible. The first type is commonly referred to as the **pulse-profile** mode of operation. In this mode the source is operating at a CW frequency, and the analyzer is armed to trigger a sweep. The RF signal is pulsed on after the sweep has been triggered. Because the 8720ES does not contain any circuits for controlling the delay between receipt of a trigger and the start of a sweep, the user must provide this delay externally. If the pulse is wide enough that several measurement points can be taken during a single pulse, then we can see the shape of the pulse over time as it is transmitted through the device under test (DUT). Each point represents the same frequency over time. This mode is useful for determining such things as pulse droop. The reason specialized network analyzers such as the 8530A have an advantage over the 8720ES in this mode is that their minimum pulse width is much narrower, 1 microsecond or less.

The second type of low PRF measurement is commonly referred to as **point-on-pulse** mode. In this mode the source is tuned, the RF pulsed on, and the analyzer is armed to trigger on each individual pulse after a predetermined time delay. Each measurement point represents a different frequency. This mode is useful for determining the frequency response of the DUT when it cannot be powered up for long periods. Because the 8720ES does not begin to sample instantly when a trigger signal is received, the user must provide an adjustable delay externally. Specialized network analyzers such as the 85108A have built in triggering circuits to adjust the delay between the time the RF pulses on and the analyzer takes a measurement. The 85108A also uses wideband detection instead of the narrowband detection used on the 8720ES, giving it an effective IF bandwidth of 1.5 MHz. This means the sample response time is much faster, which allows the user to sample at widely variable times within pulses as narrow as 5 microseconds.

There is a third type of measurement known as **peak-response** mode. This is when the pulse is narrower than the analyzer's response time, but not so narrow that the analyzer fails to register any signal. It may be considered the transition between low PRF and high PRF measurements. Because of the critical timing requirements, this mode is not recommended for the 8720E or 8753E.

High PRF measurements

If a given pulse is narrower than the minimum analyzer response time, it becomes impossible to measure a single pulse. We must restrict ourselves to measurements of a pulse train. In order to understand how such measurements are possible, we must first have some fundamental understanding of how the analyzer treats an incoming signal. This will allow us to anticipate the instrument's response to the presence of a discontinuous signal such as a pulse.

Looking at Figure 1, we see that in a normal measurement, the source passes through the transfer switch, through the port 1 coupler, and out to the DUT attached to port 1. Transmitted signals pass through the DUT, into port 2, through the port 2 coupler, and into sampler B. Reflected signals return into port 1 and pass through the port 1 coupler into sampler A. Signals that reach the samplers are down-converted to an IF, filtered and down-converted a second time to a 4 kHz IF. These signals are then digitized. After this step, all further signal processing is done digitally.

Of all the elements in the signal path, it is the digital IF bandwidth filter which exerts the greatest influence over our pulsed signal. The IF bandwidth filter is a variable bandwidth filter, ranging from 10 Hz to 6 kHz. As the analyzer sweeps in frequency, the IF bandwidth filter tracks along with the source, selecting only a narrow segment out of the center of the IF signal bandwidth. The relationship between the bandwidth of this filter and the pulse repetition frequency (PRF) largely determines the response of the analyzer to a pulsed signal.

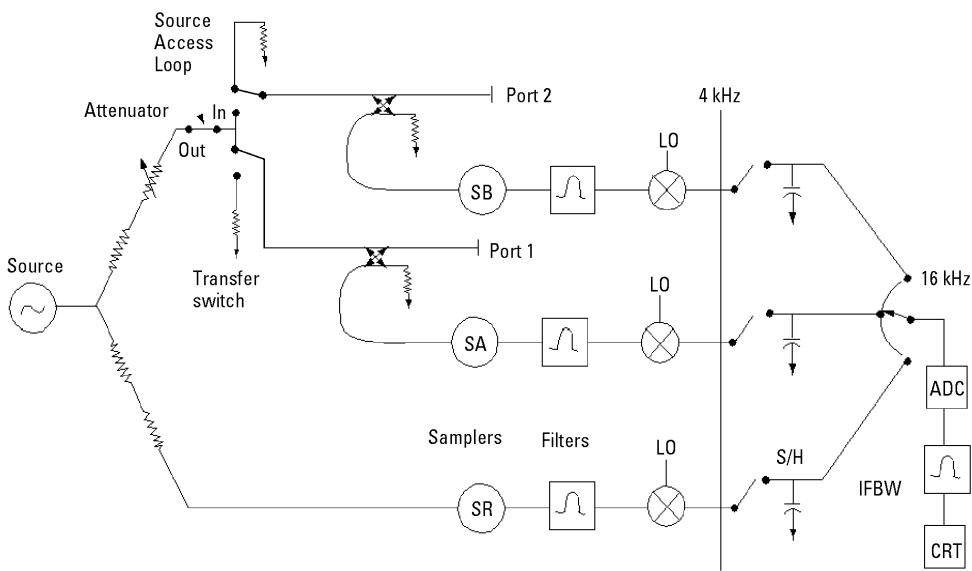

Figure 1. Network analyzer block diagram

Now consider the spectrum of a rectangular pulse train, as shown in Figure 2. This is a MatLab® simulation of a 4 kHz continuous-wave (CW) signal, modulated by a rectangular pulse train with a 200 Hz PRF and a 0.2 duty cycle. Duty cycle for our purposes is defined as:

$$\text{Duty Cycle} \equiv \text{Pulse Width} / \text{Pulse Period}$$

This signal has already been downconverted to 4 kHz and is ready to enter the IF bandwidth (IFBW) filter. The left column of the figure shows the signal in the time domain, while the right hand column shows the signal in the frequency domain. The first pair of diagrams shows the pulsed signal without any IFBW filtering. Notice that the presence of the modulating pulse transfers energy out of the central "carrier" frequency and spreads it into the sidebands. Multiple spectral lines are present, and viewed in the time domain the pulse retains a rectangular shape as it passes through the analyzer. The analyzer responds to the pulse as you might expect; part of the time an RF signal is on, and part of the time the signal is off. Notice that the spectral lines are spaced 200 Hz apart, just equal to the PRF. Notice also that as we move away from the center of the display, the first minimum (or null) occurs at the fifth spectral line. Not coincidentally, 1/5 equals our duty cycle (0.2). So, from the spectral display we can deduce the characteristics of the pulse train. These relationships hold true for any rectangular pulse, regardless of frequency or duty cycle.

The second pair of diagrams in Figure 2 shows the effect of a 3000 Hz IF bandwidth filter on the pulse. Notice that many of the sidebands have been eliminated. Notice also what has happened to the shape of the pulse in the time domain.

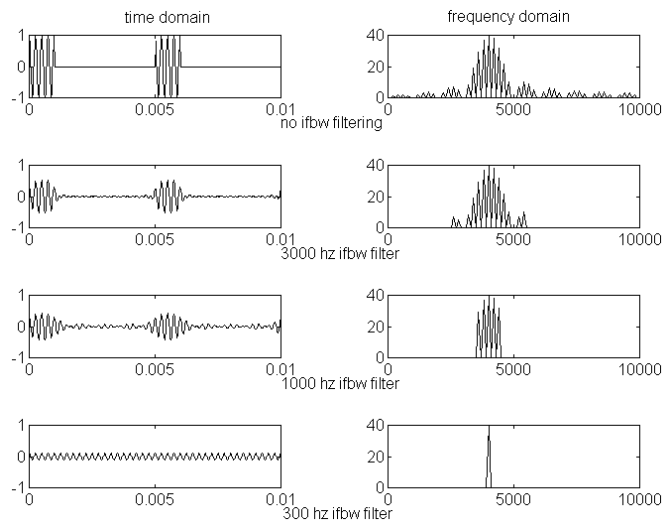

Figure 2. Effect of IF filtering on high PRF measurements

The third pair of diagrams in Figure 2 shows the effect of a 1000-Hz IF bandwidth filter on the pulse. Only a few spectral lines will fit within the bandwidth of the IF bandwidth filter. We know that there are an infinite number of spectral lines in the spectrum of any rectangular pulse; if we filter off all but a few of them with our IF bandwidth filter, what has that done to the shape of the pulse? Look at the corresponding diagram in the left column. The pulse is becoming rounded and smoothed, so that it no longer has a definite beginning or end. Some signal is always present. Since a high PRF pulse is by definition too narrow for external triggering to be effective, the analyzer responds to this signal as though the S-parameter of the DUT is continuously varying as the pulse amplitude varies. Clearly, this is an undesirable operating condition.

The fourth pair of diagrams in Figure 2 shows the effect of a 300-Hz IF bandwidth filter on the pulse. At this narrow IF bandwidth, only a single spectral line will fit within the filter bandwidth¹, and the pulse appears as a single, continuous frequency, but at a lower power level. Since this is the normal operating condition for a network analyzer, the analyzer responds normally, except that we must account for the diminished power level. The magnitude decrease in the central spectral line is logarithmically proportional to the duty cycle of the pulse. This decrease is called pulse desensitization, and the formula for computing it is:

$$\text{Pulse Desensitization} \equiv 20 * \text{Log}(\text{Duty Cycle})$$

1. This is true because this is a perfect mathematical model, so the IF bandwidth filter is perfectly centered on the spectral line. In a real analyzer, the filter could be far enough off center to capture two spectral lines.

The reason pulse desensitization occurs is because the energy of the pulse is spread throughout the spectrum, in all the sidebands. Since we have removed all the sidebands and retained only the central spectral line, we have discarded a large fraction of the available energy. In the 8510C, pulsing both the measurement channel and the reference channel can eliminate pulse desensitization. The 8720ES cannot operate with a pulsed reference channel because it has only a single reference channel that requires a continuous signal to phase lock the source to the receiver. This is also true for the 8720ES Option 400 (four samplers for true TRL calibration). Despite the fact that this instrument **does** contain separate reference channels, its hardware and firmware are not designed to allow them to be configured individually.

When making high PRF measurements, the 8720ES is limited on the low end to a PRF of 20 or greater. This is because the narrowest IF bandwidth for this analyzer is 10 Hz, and it has been found experimentally that the PRF should be at least twice the IF bandwidth for high PRF measurements. For a PRF below 20 Hz, the IF filter includes multiple spectral lines, and we are forced to use the techniques described for low PRF measurements.

On the high end of the PRF scale, this analyzer is limited by duty cycle. Once the dynamic range is reduced below about 30 dB, most measurements become impractical. Since the dynamic range of the analyzer is reduced directly by the amount of pulse desensitization, this point is usually reached when the duty cycle drops below approximately 0.001.

Finally, in order to be measured properly using the 8720ES, the pulse width must be wider than approximately 500 nanoseconds. Below this pulse width, it is difficult to ensure that the requirements for a rectangular pulse are being met. Once the pulse begins to distort, the technique used to extract the central spectral line becomes unreliable. Practically speaking, this limits the maximum PRF to about 2 MHz.

Specialized pulse analyzers such as the 85108A use wideband detection, and so are able to capture a large proportion of the available energy in each pulse. This is an advantage because it permits measurements at very low duty cycles with very little reduction in dynamic range.

Transmission examples

Normally, pulsed measurements are made on active devices. For illustration purposes we will measure a band pass filter, so that we can compare the pulsed response to a well characterized steady state response. Figure 3 shows a typical transmission measurement setup. The pulse modulator is connected to port 1 (the driving port) of the 8720ES, and the DUT is connected between the pulse modulator and port 2. For these measurements we are using a simple response calibration. The pulse modulator is an 11720A and the trigger control is provided by an 8112A.¹ When a specific setup parameter is not given, the analyzer default was used.

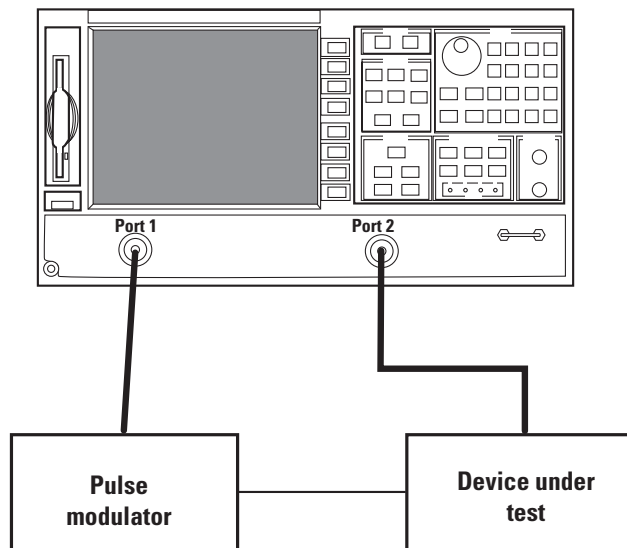
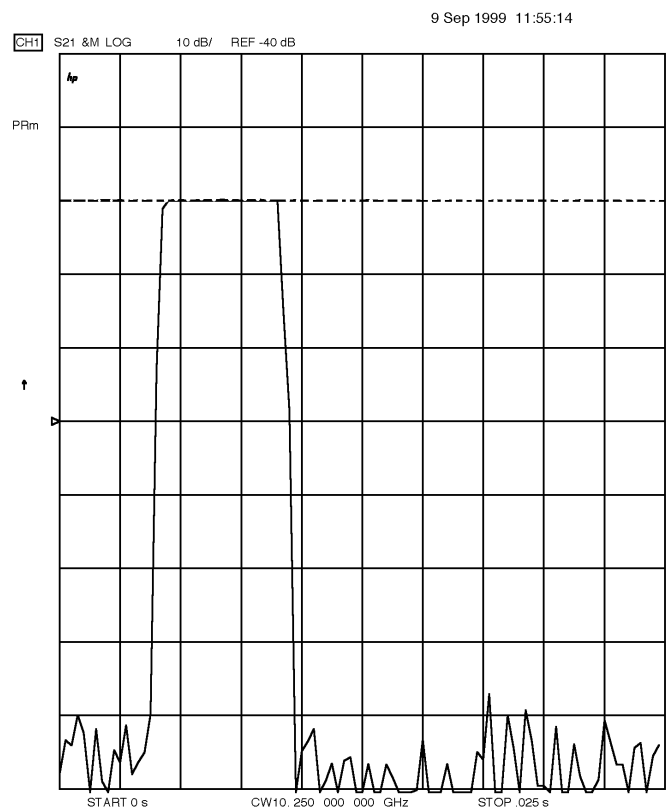

Figure 3. Simple transmission set up

Low PRF transmission examples

In Figure 4, we see the result of a low PRF measurement in **pulse-profile** mode. This shows the DUT's response over time to a pulse of RF energy at a CW frequency. The analyzer was triggered once at the beginning of the sweep (using external trigger on sweep), and allowed to free run until 101 samples were taken. The non-pulsed response of the filter is shown as a dashed line, and the pulsed response is shown as a solid line.

After the analyzer is triggered, we see only the noise floor until the moment the RF pulse comes on. Once the pulse is initiated, the response rises rapidly to match the non-pulsed response of the filter. After the RF pulse is cut off, the response diminishes rapidly to the noise floor once again. Notice that because the pulse width is much wider than the analyzer response time, there is no loss of dynamic range.



Measurement Conditions:

Frequency: 10.25 GHz
 Number of points: 101
 IF bandwidth: 6000 Hz
 Pulse width: 5 ms
 Pulse period: 200 ms
 Trigger: external on sweep
 Filter center frequency 10.25 GHz

Figure 4. Pulse profile

1. Both the 11720A and the 8112A are obsolete products with no current replacements. Pulse modulation must be provided by the user.

In Figure 5, we see the result of a low PRF measurement in **point-on-pulse** mode. This shows the DUT's frequency response to a series of RF pulses. The analyzer was triggered (using external trigger on point) during each RF pulse until 201 samples were taken. The delay between the trigger signal and the RF pulse was adjusted so that the sample was taken near the center of each pulse. The nonpulsed response of the filter (shown as a dashed line) is indistinguishable from the pulsed response. Again we see there is no loss of dynamic range. An important point to note is that the maximum external trigger rate for the 8720ES is approximately 250 Hz, so this method cannot be used for pulse repetition rates that exceed this. This can become an important consideration for reflection measurements.

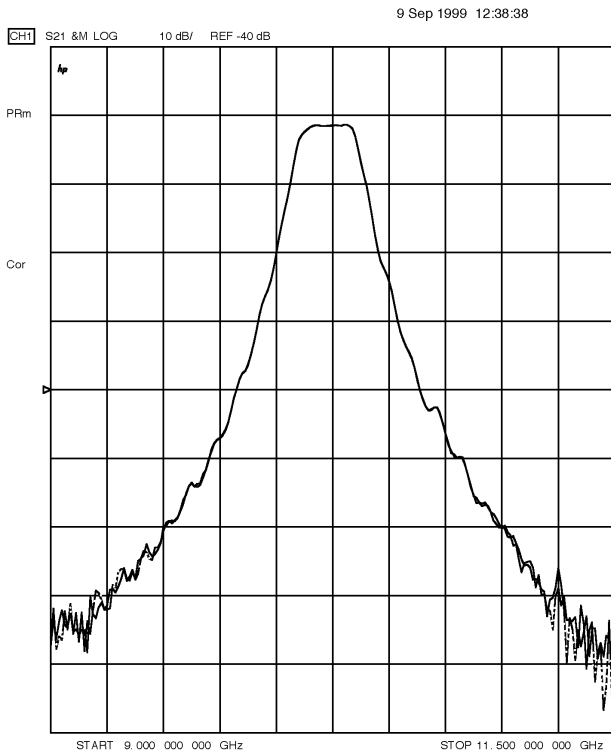

Measurement Conditions:
 Frequency: 9 to 11.5 GHz
 Number of points: 201
 IF bandwidth: 1000 Hz
 Pulse width: 5 ms
 Pulse period: 200 ms
 Trigger: external on point
 Delay: 2 ms

Figure 5. Point on pulse

High PRF transmission example

In this example we are operating on a single spectral line, as first described under the theory section for high PRF measurements. This approach requires that we account for pulse desensitization. The narrowest IF bandwidth on the 8720ES is 10 Hz, so the smallest PRF which allows the analyzer to focus on a single spectral line should be at least 20 Hz. For a PRF between 20 Hz and 20 kHz, choose an IF bandwidth less than half the PRF. This ensures that partial responses are eliminated from the skirts of the IF bandwidth filter. The widest IF bandwidth on the 8720ES is 6 kHz, so for a PRF greater than about 12 kHz, the analyzer will select a single spectral line automatically, regardless of the IF bandwidth chosen.

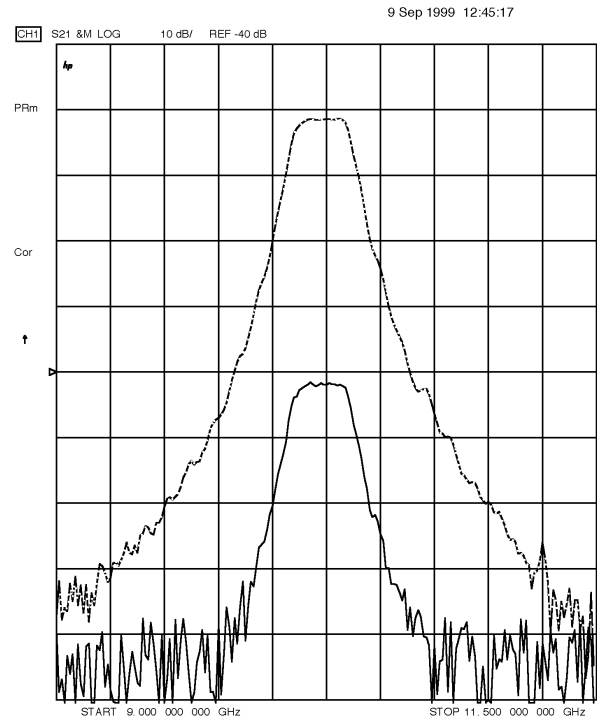

Measurement Conditions:
 Frequency: 9 to 11.5 GHz
 Number of points: 201
 IF bandwidth: 1000 Hz
 Pulse width: 2 μ s
 Pulse period: 200 μ s
 Trigger: internal
 Delay: 0 ms

Figure 6. High PRF

Figure 6 shows the filter response to a 5 kHz pulse train. Notice that no external triggering is required. Notice the decrease in the magnitude response when compared to the original (dashed line). Though it is difficult to read precisely from the figure, the decrease is about 40 dB. This agrees well with the formula for pulse desensitization. Calibration for this measurement was done with the pulse modulator biased on continuously. Pulse desensitization can be eliminated by calibrating under pulsed conditions, however, there will be an equivalent rise in the noise floor. See the calibration section for a discussion of this.

Reflection examples

Up to this point our examples have focused on transmission measurements, using a pulse modulator attached to port 1 of the network analyzer as shown in Figure 3. This is simple to set up and easy to use, but unfortunately it is often not valid for reflection measurements. In a pulsed transmission measurement, the magnitude of the received signal at port 2 depends only upon the characteristics of the DUT and the pulse itself. In a reflection measurement, the pulse modulator is present in the reflected signal path. When the modulator is on, we see the reflection characteristics of the DUT. When the modulator is off, the network analyzer source is still on, so we measure the reflection characteristics of the pulse modulator. Recalling from our earlier examples that high PRFs appear to the network analyzer as a single continuous frequency, the net effect of a high PRF using the setup of Figure 3 is that we measure some “average” response, which reflects the characteristics of both the DUT and the pulse modulator. Such a response makes this configuration unsuitable for high PRF reflection measurements.

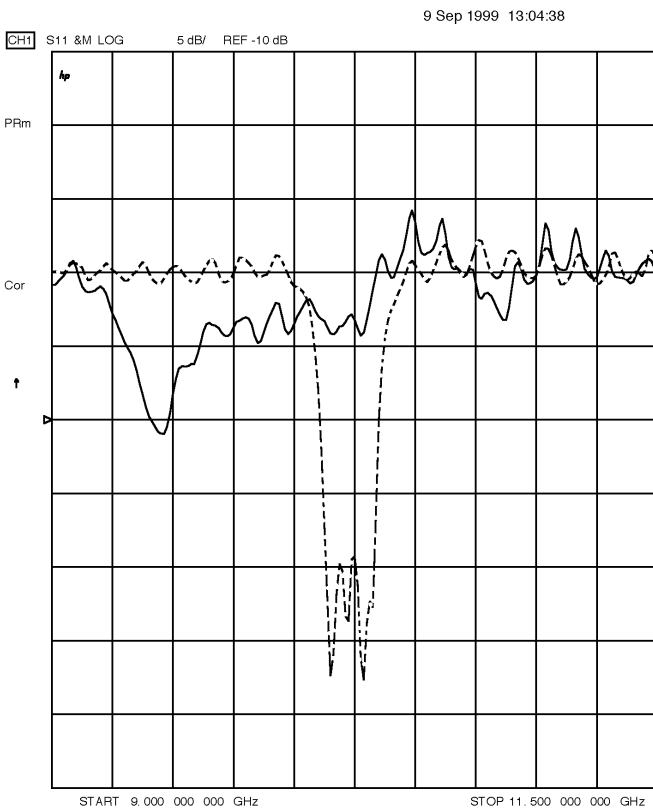

Measurement Conditions:
 Frequency: 9 to 11.5 GHz
 Number of points: 201
 IF bandwidth: 1000 Hz
 Pulse width: 5 μ s
 Pulse period: 200 μ s
 Trigger: internal
 Delay: 0 ms

Figure 7. Invalid reflection result for high PRF

If the PRF is low, we can use the setup of Figure 3 with the previously described techniques for low PRF transmission measurements to make valid measurements in the **point-on-pulse** mode.

Figure 8 shows a pulsed and non-pulsed measurement in this mode. The results are indistinguishable.

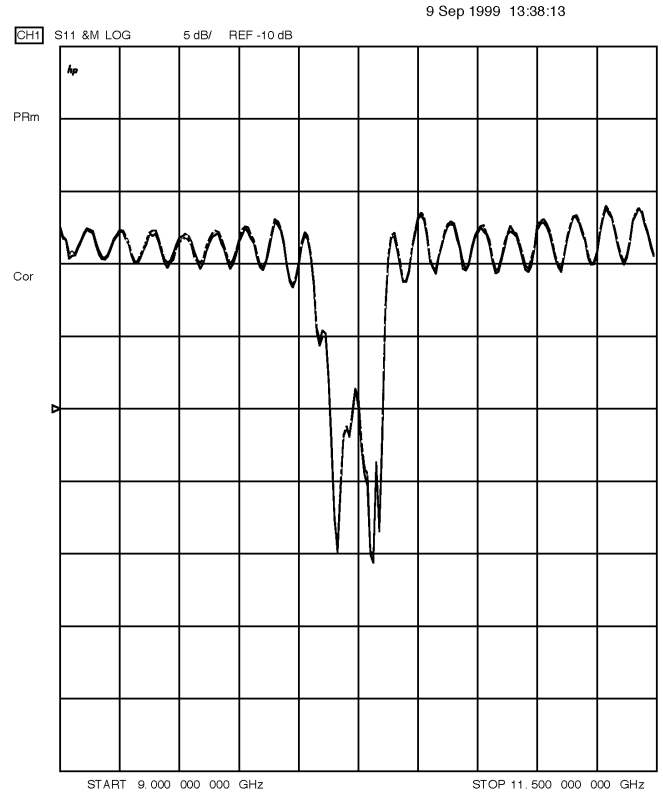

Measurement Conditions:
 Frequency: 9 to 11.5 GHz
 Number of points: 201
 IF bandwidth: 1000 Hz
 Pulse width: 5 ms
 Pulse period: 200 ms
 Trigger: external on point
 Delay: 2 ms

Figure 8. Valid reflection measurement in point-on-pulse mode

Pulse profile measurements are not valid, because in this mode the analyzer sweep begins before the RF pulse begins, so again the analyzer measures the characteristics of the pulse modulator instead of the DUT for some portion of the sweep. Figure 9 shows an example of this. The return loss when the pulse is off should equal the directivity of the analyzer, about 46 dB in this case, but it clearly does not. Instead we see the pulse arising from a baseline level of approximately -16 dB

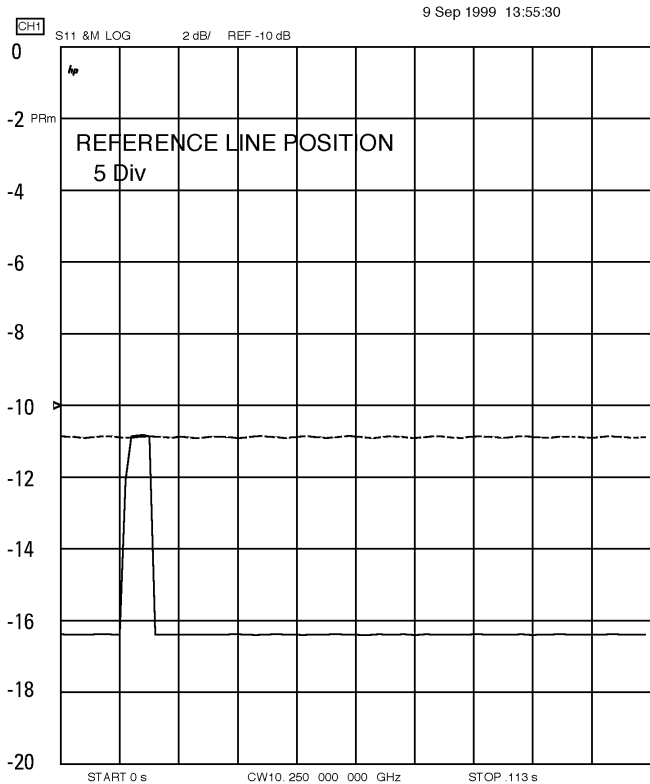

Measurement Conditions:
 Frequency: 10.25 GHz
 Number of points: 101
 IF bandwidth: 6000 Hz
 Pulse width: 5 ms
 Pulse period: 200 ms
 Trigger: external on sweep
 Delay: 2 ms

Figure 9. Invalid reflection measurement in pulse-profile mode

So is it possible to use the 8720ES to make valid reflection measurements in **pulse-profile** mode or at a **high PRF**? One way to do so is to use an external coupler between the pulse modulator and the DUT. Another way is to use the 8720ES configurable test set (Option 014) to make many such measurements possible. This option provides an external access to the RF signal path prior to the transfer switch and couplers. The insertion points are labeled **in** and **out** in Figures 1 and 10. With the pulse modulator in this position, it is no longer present in the reflected signal path since it precedes the port 1 coupler. This permits reflection measurements to be made using the same techniques described for transmission measurements. It has the added benefit of allowing full two-port error correction to be performed, which is an advantage in many transmission measurements as well.

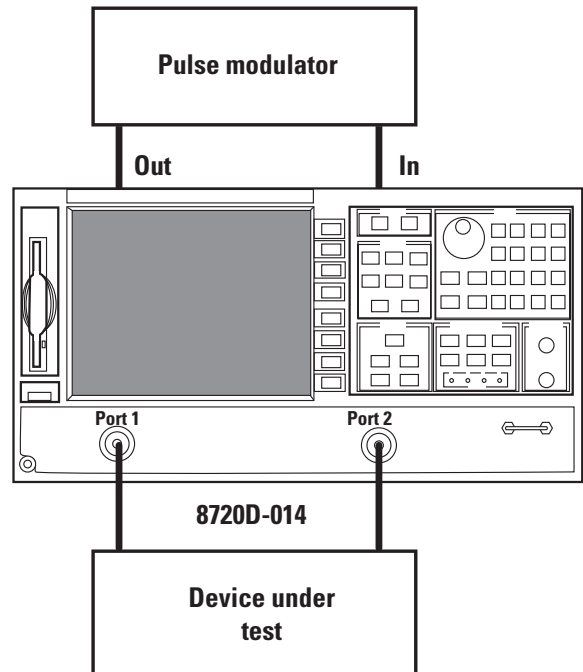

Figure 10. Pulse modulator in rear access loop (Option 014)

Calibration

We need to consider ways to improve the accuracy we can expect with pulsed measurements. The primary consideration when calibrating is to have the analyzer completely set up before the calibration is begun. The pulse modulator, triggering circuit, and all other hardware should be in place, and all instrument settings should be complete before starting a calibration. The only thing absent from system should be the DUT. This ensures that additional errors will not be introduced into the system after the calibration is complete.

The type of calibration chosen depends upon the type of measurement being made and the accuracy required. We will consider three types of calibration: response calibration, enhanced response calibration, and full two-port calibration.

Response calibration (normalization) is most often used for transmission measurements, though it is also possible for reflection measurements (using a short as a calibration standard). It removes only the frequency response error; however this is often sufficient since this is usually one of the largest errors in the measurement system. The advantages of this method are that it is easy and quick and requires only a single calibration standard. The disadvantage is that the measurement uncertainty is higher for this method than for other methods¹. This is because the accuracy of any calibration depends in some measure upon the port match of the analyzer and the DUT. Placing well-matched 6 dB pads on the ports before calibrating will sometimes solve this problem, but at the expense of dynamic range.

Enhanced response calibration is a new feature offered on the 8720ES. This technique corrects for frequency response error, and in addition corrects for source match. This is an advantage because it removes any ripple in the response due to the raw port match of the analyzer. This in turn significantly improves the measurement uncertainty. The disadvantages of this method are that it requires four calibration standards (short, open, load, thru) and that it requires more time and attention to detail than a simple response cal. Once calibrated, the analyzer sweeps just as quickly as it would with a response cal.

Full two-port error correction provides the highest accuracy possible using short, open, load, through (SOLT) calibration standards. As the name implies, it corrects for errors at both ports, including frequency response, source match, load match, transmission tracking, reflection tracking, and if desired, cross talk. The disadvantages of this method are that it requires up to seven calibration standards (when both sexes are considered), it requires twice as many connections as enhanced response cal (with the attendant opportunity for mistakes) and once completed, it runs at half the speed of an analyzer using enhanced response cal (because both a forward and a reverse sweep are required before the parameters can be updated).² Table 2 shows the various combinations of measurement type and calibration that are compatible with pulsed measurements.

Table 2-Calibration options for various measurement configurations³

Operating Mode	Measurement Type	Calibration Type ⁴	Standard 8720	8720 with Option 085 ⁵	Modulation during Calibration
Low PRF Pulse Profile	Transmission	Response	OK	OK	OFF
		Enhanced Response	OK	OK	OFF
		Full two-port	OK	OK	OFF
	Reflection	Response	Not Advised	OK	OFF
		Full one-port	Not Advised	Not Advised	Not Advised
		Full two-port	Not Advised	Not Advised	Not Advised
Low PRF Point on Pulse	Transmission	Response	OK	OK	Either
		Enhanced Response	OK	OK	Either
		Full two-port	OK	OK	Either
	Reflection	Response	OK	OK	Either
		Full one-port	OK	OK	Either
		Full two-port	OK	OK	Either
High PRF	Transmission	Response	OK	OK	Either
		Enhanced Response	OK	OK	Either
		Full two-port	OK	OK	Either
	Reflection	Response	Not Advised	OK	ON
		Full one-port	Not Advised	OK	ON
		Full two-port	Not Advised	OK	ON

1. A measurement uncertainty calculator is available on the web at www.agilent.com (Search for *uncertainty calculator*)
2. More details on error correction in are covered in Application Note 1287-3, *Applying Error Correction to Network Analyzer Measurements*, which is available at www.agilent.com (Search for the number 1287-3)
3. Some of these entries are counterintuitive until they are viewed in terms of the measurement uncertainty equations. All combinations were verified empirically.
4. Two-port calibration assumes the DUT is bilateral, for example it transmits in both directions
5. Assumes the pulse modulator is inserted in the RF access loop provided by these instruments

Is it better to calibrate with the pulse modulator biased on continuously or, should it be pulsing, as it will be during the measurement? In general, it is best to calibrate with the modulator pulsing as it will be during the measurement whenever possible. This eliminates one of the variables in the measurement. However, there are some exceptions.

For low PRF measurements using **pulse-profile** mode, the modulator should always be biased on (not pulsing) during calibration. If it is pulsing, the error correction algorithm in the network analyzer will overcompensate when the pulse is on. This defeats the purpose of pulse profiling.

For low PRF measurements using **point-on-pulse** mode, there is no noticeable difference between the two methods, provided the proper trigger setup time is observed. In this mode the analyzer is only sampling when the pulse is on.

For high PRFs, the only difference between the two methods for transmission measurements is that calibrating with the pulse modulator pulsing eliminates pulse desensitization. However, there is an equivalent rise in the noise floor, so that there is no net gain in the dynamic range. For high PRF reflection measurements, it is important to have the modulator pulsing, so that the directivity term in the error correction array does not contain values so large that they mask the response of the DUT under pulsed conditions.

Note that all three cases are still subject to the requirements dictated by the placement of the pulse modulator, and that in some cases reflection measurements may not be possible under pulsed conditions.

Conclusion

The 8720ES and 8753ES have not generally been considered capable of pulsed measurements. However, if the pulse width is wider than 1 millisecond, or the duty cycle is greater than .001, it is possible to make many types of pulsed measurements with a good degree of accuracy and repeatability using these instruments. Optional analyzer features such as an external source loop make them capable of an even wider range of measurements, and also make available the accuracy of two-port error correction.

The major advantage of using these analyzers instead of more specialized pulse analyzers such as the 85108A is their relatively low cost. The main disadvantage of these instruments for pulsed measurements is that they use narrowband detection. This makes them too slow to respond to very narrow pulses when operating in the low PRF mode, and it also means they must sacrifice dynamic range in order to measure low duty cycles when operating in the high PRF mode. A secondary disadvantage of the instruments described in this application note is that they compare a pulsed measurement channel to a nonpulsed reference. This tends to increase trace noise, particularly for phase measurements.

In general, the 8720ES and 8753ES are best suited for pulsed transmission measurements at a PRF between 20 Hz and 2 MHz. Reflection measurements are possible if the pulse is wide enough to allow external triggering, or if the pulse modulator can be inserted in the signal path ahead of the reflection coupler. With some ingenuity and a basic understanding of the underlying phenomena, many types of pulsed measurements have been demonstrated to be feasible.

References:

1. *Techniques for Measuring RF and MW Devices in a Pulsed Environment*, Paul Schmitz and Mohamed Sayed, Hewlett Packard, February 5, 1993
2. *Pulsed Antenna Measurements with the 8530A Microwave Receiver*, John Swanstrom and Robert Shoulders, Hewlett Packard, undated.
3. *85108 Pulsed-RF Network Analyzer System*, Appendix E, October 22, 1998
4. Product Note 8510-9, *Pulsed-RF network measurements using the 8510B*, undated

Agilent Technologies' Test and Measurement Support, Services, and Assistance

Agilent Technologies aims to maximize the value you receive, while minimizing your risk and problems. We strive to ensure that you get the test and measurement capabilities you paid for and obtain the support you need. Our extensive support resources and services can help you choose the right Agilent products for your applications and apply them successfully. Every instrument and system we sell has a global warranty. Support is available for at least five years beyond the production life of the product. Two concepts underlie Agilent's overall support policy: "Our Promise" and "Your Advantage."

Our Promise

Our Promise means your Agilent test and measurement equipment will meet its advertised performance and functionality. When you are choosing new equipment, we will help you with product information, including realistic performance specifications and practical recommendations from experienced test engineers. When you use Agilent equipment, we can verify that it works properly, help with product operation, and provide basic measurement assistance for the use of specified capabilities, at no extra cost upon request. Many self-help tools are available.

Your Advantage

Your Advantage means that Agilent offers a wide range of additional expert test and measurement services, which you can purchase according to your unique technical and business needs. Solve problems efficiently and gain a competitive edge by contracting with us for calibration, extra-cost upgrades, out-of-warranty repairs, and on-site education and training, as well as design, system integration, project management, and other professional engineering services. Experienced Agilent engineers and technicians worldwide can help you maximize your productivity, optimize the return on investment of your Agilent instruments and systems, and obtain dependable measurement accuracy for the life of those products.

For more assistance with your test & measurement needs or to find your local Agilent office go to

www.agilent.com/find/assist

Product specifications and descriptions in this document subject to change without notice.

**Copyright © 2000
Agilent Technologies
Printed in USA 5/00
5980-0798E**

