

7 Hints for Making Innovative Signal Source Measurements in Wireless RF Design and Verification Using the Signal Source Analyzer

Application Note



E5052A Signal Source Analyzer (SSA) Breaks the Current Measurement Paradigm and Defines an Entirely New Class of Instrument



Agilent Technologies

Importance of RF Design and Verification in Today's Wireless Communication Systems

Market demands for today's wireless communications systems

Today's wireless communications systems are required to simultaneously provide better service quality and lower costs. These expectations are becoming increasingly difficult for RF design engineers to accomplish due to multiple market demands - such as higher data rates, more capacity and efficient spectrum reuse, multiple-mode operation (dual-mode, tri-mode), longer battery life, smaller phone size, and a wide variety of software features such as i-mode.

Table 1. Examples of technical challenges to meet market demands

Market demands	Technical challenges
To achieve higher data rates...	Higher order and/or new modulation/demodulation schemes (compressed decision point in the constellation domain like 64 QAM/CDMA, OFDM modulation, etc.)
For more capacity and efficient spectrum reuse...	Higher frequency operation (system noise level increase, etc.)
For multiple-mode operation...	Hybrid system operation (multiple RF circuits)
To achieve longer battery life...	Low power consumption by RF module, IC
To make the phone smaller...	Additional integration (IC) (unknown spurious, noise, etc.)
To run a wide variety of software features...	More powerful CPU/DSP processing

Importance of RF design and verification and today's technical challenges

Although the baseband processing and software implementations are getting more important in today's wireless communications systems, RF design continues to be the key area to meet or exceed customer demands and to differentiate your products against competitors. This is because the RF design will determine the most important basic performance of your products, like transmitter performance, (modulation quality, adjacent channel power ratio (ACPR), harmonics, spurious emission, etc.) and receiver performance (sensitivity and selectivity, etc.), as shown in Figure 1 and 2.

To meet today's market demands, RF designers face many technical challenges. Table 1 highlights the types of technical challenges that RF designers are required to overcome in order to meet specific market demands.

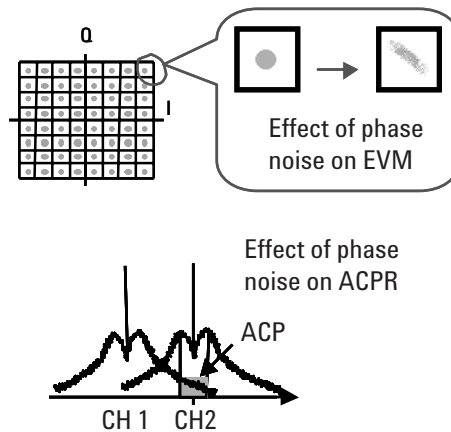

Figure 1. Signal source effects in transmitter

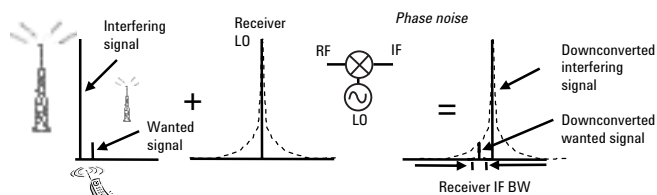
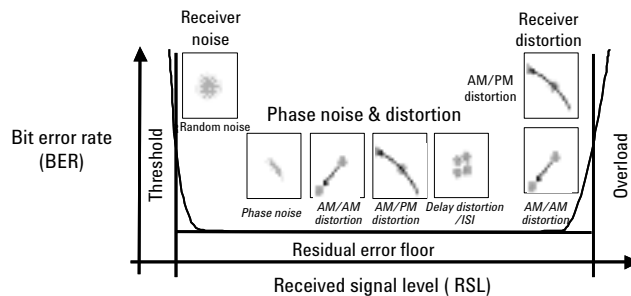

Figure 2. Signal source effects in receiver

Current Signal Source Design Process - Issues and Challenges

Signal source design process

As shown in Figure 3, the typical signal source design process is to purchase or design a crystal oscillator and voltage controlled oscillator (VCO), then to design a loop filter for the PLL synthesizer in the circuit verification stage. The designers face issues and challenges with each process, however sometimes it is difficult for the designers to clearly identify or define the issue.

Lack of verification for crystal oscillators, VCOs

The high quality factor (Q) of the crystal resonator and excellent long-term stability are ideal for wireless applications. If the crystal source is incorrectly “assumed” to be good, considerable effort may be expended in vain trying to fix the wrong components. In high-performance wireless equipment with complex modulations, achieving the lowest possible phase noise begins with the crystal source, so precise characterization is essential. However, it is very hard to make such a low phase noise measurement with the current phase noise test instruments. Thus, the wireless equipment manufacturers do not inspect crystal oscillators and this is one of the biggest issues when designing a RF circuit. Furthermore, VCOs and synthesizers are also not fully verified or well designed due to the limited performance and features of traditional test instruments.

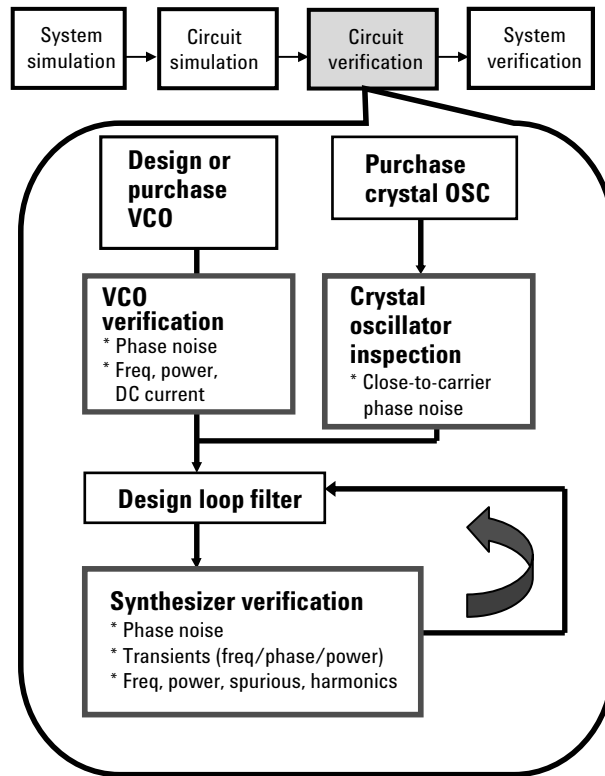

Figure 3. Signal source design process

No optimum process for PLL synthesizer cut & try

Typical synthesized oscillators combine a VCO with a phase locked loop (PLL) IC, frequency reference (crystal /TCXO) and a loop filter. The loop filter design must integrate all of the components to establish, among other things, a tradeoff between phase noise and transient response. It is very important to quickly do the cut & try for designing the loop filter by repeating the measurements of phase noise, transients, and spurious to optimize the system performance. This tedious process must be done not only for one condition but various frequency switching conditions. It is unfortunately not possible to optimize this process by using traditional test instruments.

New measurement challenges for signal source design

The recent signal sources require new measurement challenges. For instance, the phase noise performance is getting lower and lower like < -170 dBc/Hz even with the low output power level from signal source under test. This makes it much tougher for traditional test instruments to measure phase noise. The transient speed is also very fast now and although the new requirement is less than 100 nanoseconds resolution, the traditional instruments cannot provide enough frequency and time resolutions for such high speed switching signal sources.

Traditional Signal Source Measurement Paradigm and the New E5052A Signal Source Analyzer

Traditional signal source measurement paradigm

RF designers who wish to perform all of signal source measurements have to employ multiple stand-alone instruments, connecting and reconnecting the signal source under test for each type of measurement. This tedious process takes too much time to learn and is prone to error. To automate the measurements and eliminate the connections and reconnections, they can also cable together general-purpose and test-specific instruments. This requires writing complicated multi-instrument test routines and removing these instruments from use in other areas. In most cases, it requires an entire day just to make a phase noise measurement using these test solutions, including system set-up and calibration.

E5052A SSA - an entirely new class of instrument

In contrast, the E5052A SSA requires only a single connection to the signal source under test, and most tests can be performed by pressing a single button. Measurement time is reduced more than 10 times, and measurements are also much easier to perform. This means measurements can generally be made in a few minutes.

The E5052A SSA is an entirely new class of instrument that can evaluate the critical performance characteristics of nearly all types of RF and microwave signal sources. It replaces a large, complex rack of test equipment with a single instrument that performs tests faster and more accurately, at a lower cost and with unprecedented simplicity.

Wide variety of signal sources can be verified

The E5052A SSA can characterize the majority of signal sources, including crystal oscillators, voltage controlled oscillators (VCOs), surface acoustic wave (SAW) oscillators, dielectric resonator oscillators (DROs), YIG-tuned oscillators, all types of frequency synthesizers (PLL synthesizer), local oscillator (LO) circuits, and RF and microwave integrated circuits (ICs). The instrument's capabilities include measurement of phase noise, modulation domain (frequency, power, phase transient), power, frequency, and DC current consumption, and provides a spectrum monitor function, and two ultra-low noise DC sources for the signal source under test as well.

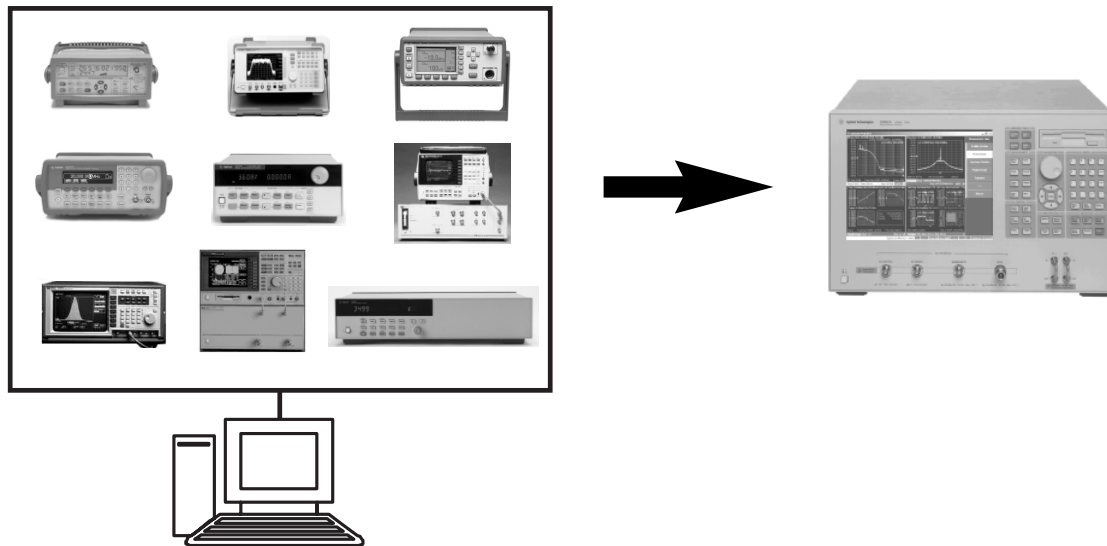

Figure 4. E5052A SSA - an entirely new class of instrument

Table 2. E5052A SSA low cost model (Option 011) and standard model

	E5052A Option 011	E5052A standard
Phase noise	<ul style="list-style-type: none"> • 10 Hz to 40 MHz offset • Limited cross-correlation function, high-cost performance model for synthesizer and VCO 	<ul style="list-style-type: none"> • 1 Hz to 40 MHz offset range • Up to 10,000 times cross-correlation (20 dB improvement) for very low phase noise measurement like crystal oscillator
Transients	Yes (frequency/phase/power)	Yes (frequency/phase/power)
Frequency/power/DC current	Spot measurement mode (tester mode) only	Spot measurement mode and DC voltage swept analyzer mode
Spectrum monitor	Yes	Yes
Built-in DC sources	Yes	Yes

HINT 1. Making “True” Phase Noise Measurements for Free-Running Signal Source Devices

The most straightforward method of measuring phase noise is to input the test signal into a spectrum analyzer and directly measure the power spectral density of the signal source with a 1 Hz resolution bandwidth, which is called a direct SA method. The advantage of this method is that it’s easy to use, but there are some limitations. It assumes that all carrier sideband energy is due to phase modulation, since it cannot distinguish between that and sideband energy from amplitude modulation sources. It also requires a signal source with adequate long-term stability to make the measurement, given the resolution bandwidth of the spectrum analyzer. This means that if the signal source being measured is drifting fast, the resolution bandwidth filter cannot adequately capture the signal and significant measurement errors can occur as shown in Figure 5.

Thus, a spectrum analyzer is an essential and powerful tool for basic RF tests and digital modulation

analysis. However, its phase noise measurement is not adequate when measuring free-running signal source devices such as crystal VCOs (VCXOs), VCOs, voltage controlled dielectric resonant oscillators (DROs), and YIG oscillators (actually a current controlled oscillator). All of the signal source’s long-term stability (seconds, minutes, hours, etc.) is typically very poor and needs to be phase-locked to a stable reference signal source in order to measure the phase noise.

The E5052A SSA, on the other hand, employs a reference source/PLL method with a new cross-correlation technique to measure free-running signal source devices. The principle of this method is similar to that of an actual radio demodulator. Increased sensitivity can be obtained by nulling or demodulating the carrier, then measuring the noise of the resulting baseband signal, so the true phase noise can be measured, as shown in Figure 6.

In addition, SSA’s internal PLL is fully automatic and the phase noise can be measured quickly and easily by just hooking up the signal source to the RF input port.

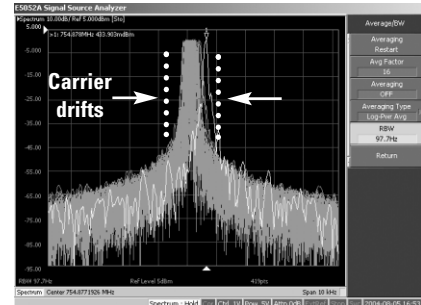

Figure 5. VCO drifts (E5052A SSA spectrum monitor persistence mode)

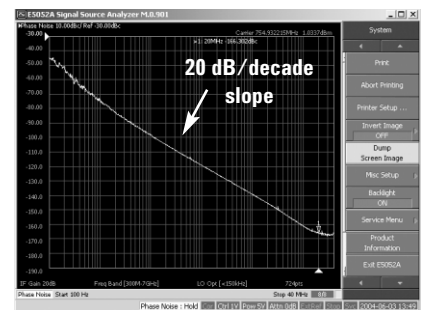

Figure 6. VCO phase noise measurement by the E5052A SSA

Table 3. Phase noise measurement comparison between the E5052A SSA and a traditional spectrum analyzer

Test Instrument	E5052A SSA	Spectrum analyzer
Phase noise test method	Reference source/PLL method + cross-correlation technique	Direct SA (heterodyne) method
Advantages	<ul style="list-style-type: none"> • Very easy-to-use by fully automatic PLL • Tracking VCO drift by PLL • AM noise can be suppressed • Best dynamic range and sensitivity by PLL/reference source method with two built-in independent low phase noise LO’s • Overcoming internal LO phase noise by new cross-correlation technique (up to 20 dB improvement) 	<ul style="list-style-type: none"> • Easy-to-use
Limitations	<ul style="list-style-type: none"> • Cross-correlation needs to take time depending on the setting 	<ul style="list-style-type: none"> • AM noise can not be suppressed • Frequency drift can not be tracked • Limited phase noise performance due to Internal LO phase noise

HINT 2. Overcoming Test Instrument's LO Phase Noise for Low Phase Noise Signal Sources

The low phase noise signal sources such as crystal oscillators typically have very low phase noise. To measure such a low phase noise, the direct SA method and even the dedicated phase noise test system using a reference source/PLL method do have an unavoidable limitation. The phase noise measurement is actually limited by the spectrum analyzer's internal phase noise and the signal generator's (reference source) phase noise used in the phase noise test system. Furthermore, the measurement speed is very slow and the phase noise test system also requires a tedious set up and calibration process before making a phase noise measurement.

The E5052A SSA has two built-in low noise sources and the new cross-correlation technique further allows the designers to overcome the SSA's internal phase noise limitation by up to 20 dB as shown below. This means that the SSA can now easily measure the signal sources with very low phase noise.

Number of correlation	10	100	1000	10000
Phase noise improvement	5 dB	10 dB	15 dB	20 dB

Figure 9 through 11 show actual measurement examples of crystal oscillator's very low phase noise at close-to-carrier, VCO phase noise with 20 dB/decade slope, and synthesizer's phase noise.

Most crystal oscillator's low phase noise at close-to-carrier can now be measured with the SSA cross-correlation technique. The recent VCO and synthesizers have low phase noise at far-from-carrier like -168 dBc @ 20 MHz offset and it can be measured using another measurement technique called "frequency discriminator" with the dedicated phase noise test system, or the combination of "spectrum analyzer, notch filter, and power amplifier". These two measurement techniques are very complex and require a vast amount of time and resources. The SSA now allows the designers to make low phase noise measurements at far-from-carrier, using the new cross-correlation technique quickly and easily.

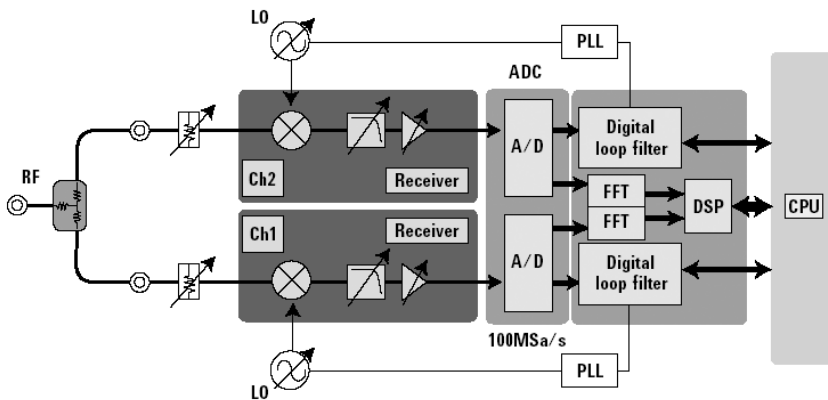

Figure 7. E5052A SSA reference source/PLL phase noise measurement method with the two channel cross-correlation technique

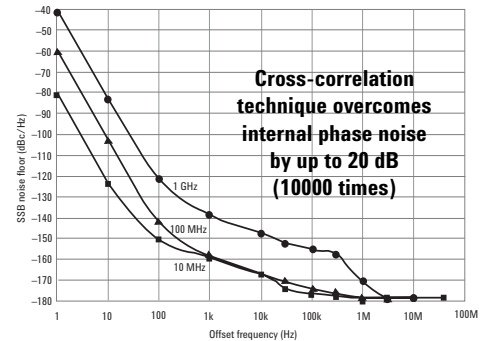

Figure 8. E5052A SSA standard model phase noise sensitivity (correlation = 1)

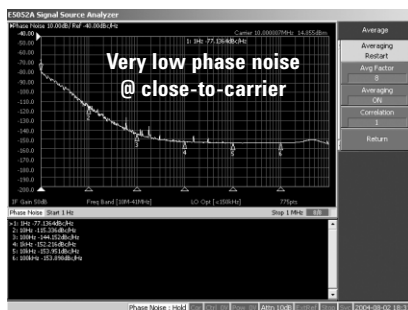

Figure 9. Crystal oscillator phase noise measurement by the E5052A SSA

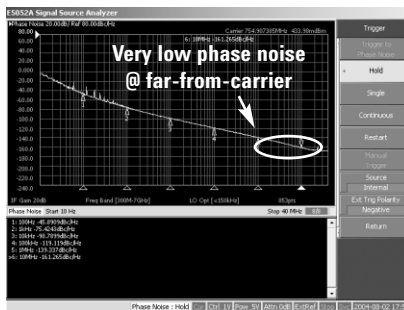

Figure 10. Free-running VCO phase noise measurement by the E5052A SSA

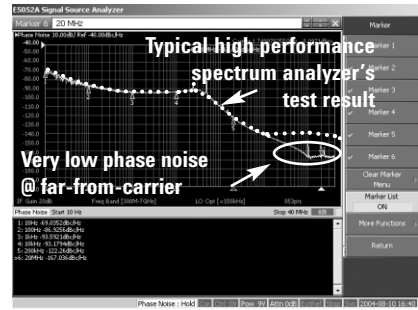

Figure 11. Synthesizer phase noise measurement by the E5052A SSA

HINT 3. Using Ultra-Low Noise DC Sources for Voltage Controlled Type Signal Source Devices

The general purpose stand-alone DC power sources are always used to supply DC power voltage and DC control voltage for voltage controlled type signal source devices such as VCXOs, VCOs, and voltage controlled SAW oscillators (VCSOs). Since the purpose of the phase noise measurement is to measure the noise caused by phase modulation, it is highly affected by the noise itself from DC sources. So the external low pass filter with low cut-off frequency must be made for noise rejection between DC sources and signal source under test. In this case, it takes more time for the phase noise measurement to be completed depending on the cut-off frequency or time constant of the low pass filter. In addition, the phase noise may not be properly measured because the signal source under test keeps drifting in the measurement period due to the fluctuations by the temperature changes etc.

The E5052A SSA has precisely conditioned, exceptionally ultra-low noise DC sources for both the DC power voltage and the DC control voltage inside. In particular, the DC control voltage source gives unparalleled low noise performance ($1\text{nV}/\sqrt{\text{Hz}}$ at 10 kHz offset), which enables the very accurate phase noise measurement without using stand-alone DC sources and an external low pass filter. The available voltage and current for the DC control voltage is from -15 V to +35 V with maximum 20 mA, DC power voltage from 0 V to +16 V with maximum 80 mA as shown in Figure 13.

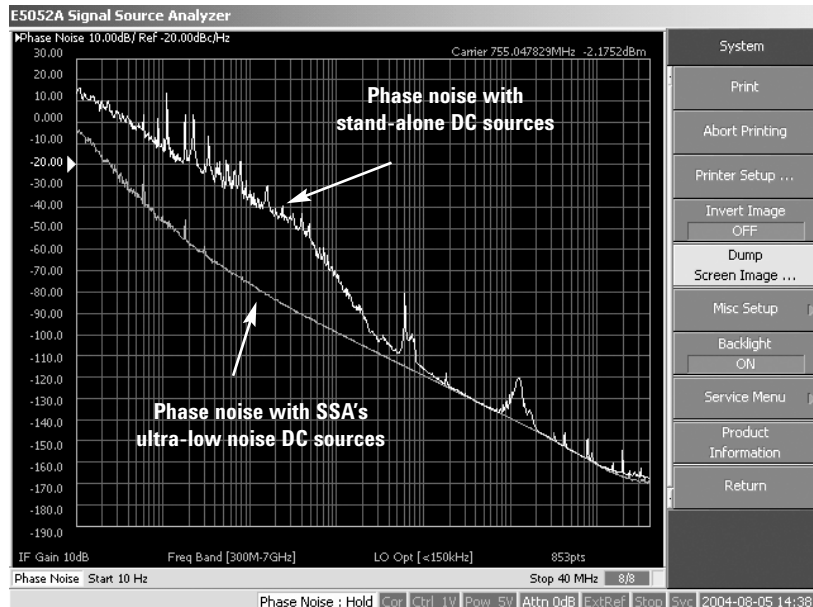

Figure 12. Phase noise measurement comparison between built-in ultra-low noise DC sources and stand-alone DC sources

A DC ammeter is also available at DC power voltage, so the DC current measurement can be easily and quickly done while providing DC sources to the signal source under test.

As a result, the E5052A SSA keeps locking on the free-running VCO signal by internal automatic PLL architecture and its phase noise measurement is very precise with ultra-low DC sources as shown in Figure 12.

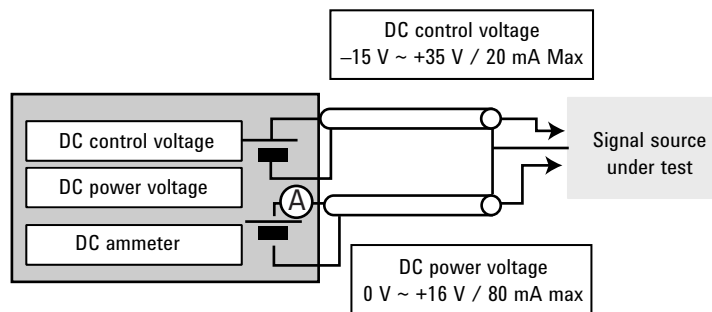

Figure 13. E5052A SSA built-in ultra-low noise DC sources and DC ammeter

HINT 4. Evaluating Signal Source Behavior Under Real Operating Conditions

Frequency, power, and DC current are basic test parameters to be measured for signal source characterization. The designers must use the stand-alone test instruments to make these measurements, which include the frequency counter, power meter, and DC ammeter. For voltage controlled type signal sources, the linearity also must be verified by sweeping either DC control voltage or DC power voltage, so it is very complex to implement these measurements by controlling DC sources along with the frequency counter, power meter, and DC ammeter.

The E5052A SSA capabilities include a frequency counter, power meter, and DC ammeter as well as DC sources – all in one box. The tester mode in Figure 15 works just like the stand-alone test instruments to quickly check the frequency, power, and DC current at fixed DC control and DC power voltages. The SSA also allows the designers to sweep either DC control voltage or DC power voltage to measure tuning sensitivity or frequency pushing as shown in Figure 16 and 17. For frequency vs. DC control voltage or DC power voltage display, the differentiation of these curves [Hz/V] can also be measured quickly and easily.

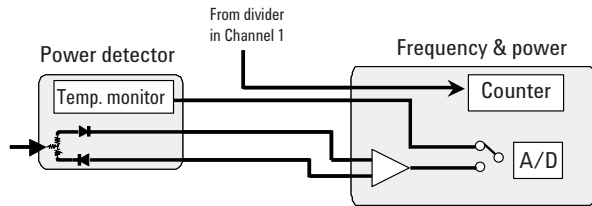

Figure 14. E5052A SSA frequency counter and power meter

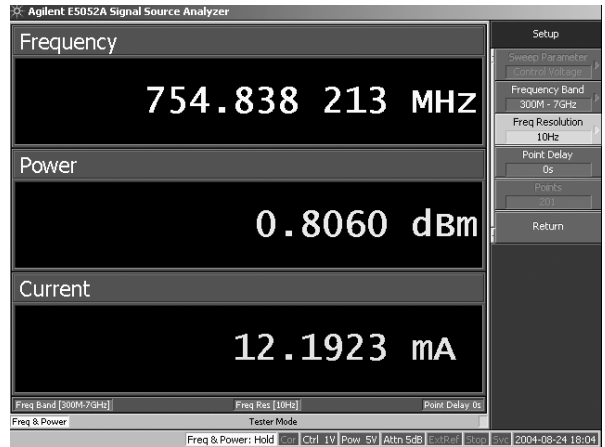

Figure 15. Frequency, power, DC current measurements by the E5052A SSA tester mode

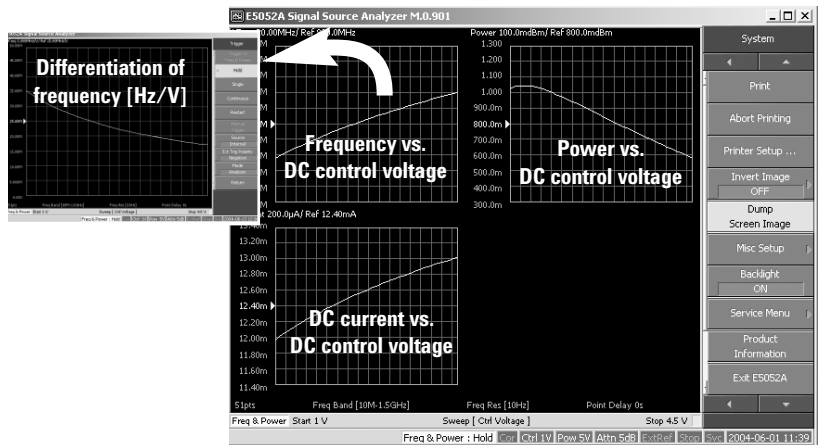

Figure 16. Tuning sensitivity by the E5052A SSA analyzer mode

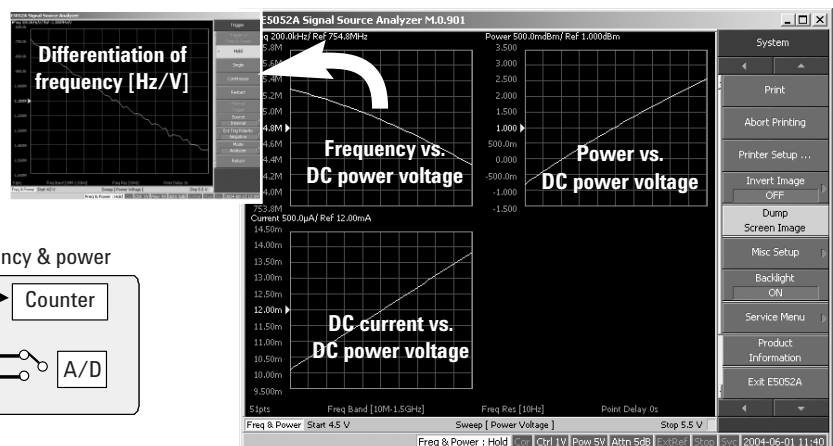

Figure 17. Frequency pushing by the E5052A SSA analyzer mode

HINT 5. Achieving Very Fast Transient Measurements for the PLL Synthesizer

The switching speed in the recent wireless communications systems is getting faster by adopting the fractional-N PLL synthesizer technique. The designers must capture the transient phenomena and then analyze it from the various aspects including frequency, power, and phase transients. The traditional test instruments like modulation domain analyzer (MDA) and vector signal analyzer (VSA) are powerful tools for transient measurements. However these are not optimum tools because of missing features like phase and power transients as well as insufficient frequency and time resolutions, as shown in Figure 18.

The E5052A SSA has two independent channels for transient measurements with 10 to 100 times better frequency and time resolutions in comparison with the traditional test instruments. The SSA also supports all frequency, power, and phase transients. One channel is used as “wideband mode (4.8 GHz span)” and the other channel is used as “narrowband mode (25.6 MHz or 1.6 MHz span)”. This allows the designers to look into the detail transient phenomena in narrowband mode while checking the overall transient in wideband mode.

Because the relationship between frequency resolution and time resolution is an inherent trade off, the designers can use either a 1.6 MHz or a 25.6 MHz span in narrowband mode depending on the

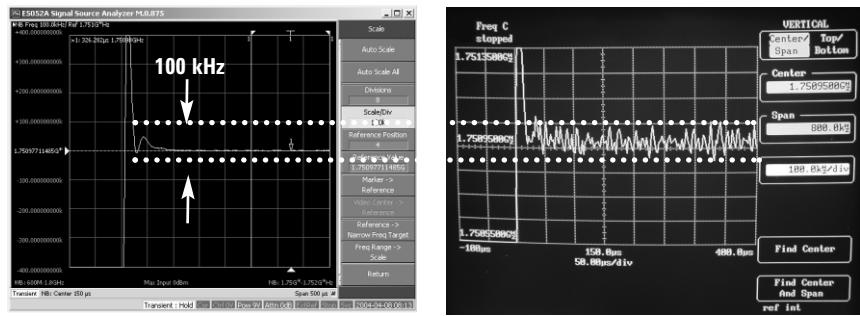

Figure 18. Comparison of frequency resolution between the E5052A SSA and modulation domain analyzer (Time Span: 500 us, Frequency Span: 800 kHz)

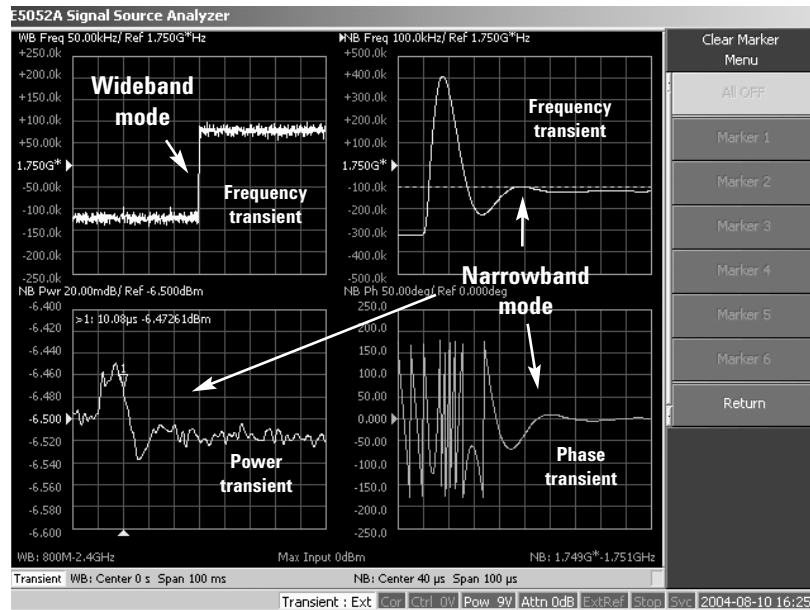

Figure 19. Transient measurement by the E5052A SSA

test requirements. When using a 25.6 MHz frequency bandwidth, the best time resolution can be obtained. On the other hand, a 1.6 MHz frequency bandwidth provides the best frequency resolution. SSA

automatically sets the best resolutions depending on the measurement time (time span in X axis) as shown in Table 4.

Table 4. E5052A SSA narrowband transient frequency and time resolution

1.6 MHz frequency bandwidth in narrowband mode

Measurement time [usec]	100	200	500	1000	2000	5000	10000	20000	50000	100000
Frequency Resolution [Hz]	110	110	110	39	20.5	14	5	5	5	5
Time resolution [usec]	0.16	0.32	0.8	0.8	1.6	4	8	20	80	160
Number of point	626	626	626	1251	1251	1251	1251	1001	626	626

25.6 MHz frequency bandwidth in narrowband mode

Measurement time [usec]	10	20	50	100	200	500	1000	2000	5000	10000	20000	50000	100000
Frequency resolution [Hz]	7000	7000	7000	7000	3000	883.9	312.5	312.5	312.5	312.5	312.5	312.5	312.5
Time resolution [usec]	0.01	0.02	0.05	0.1	0.2	0.51	1	2	6.25	12.5	25	62.5	125
Number of point	1001	1001	1001	1001	1001	1001	1001	1001	1001	801	801	801	801

HINT 6. Optimizing “Cut & Try” for the PLL Synthesizer Design

Once the crystal oscillator and VCO design or verification have been precisely done, the designers must achieve a very fast PLL synthesizer switching speed while maintaining a good phase noise performance and suppressing spurious by optimizing the loop filter design. This process always requires a large amount of resources and time for cut & try using the traditional stand-alone test instruments back and forth, including the dedicated phase noise test system, spectrum analyzer, modulation domain analyzer (MDA), vector signal analyzer (VSA) etc.

To effectively and efficiently optimize the PLL synthesizer design and verification process, the E5052A SSA provides an innovative way to optimize the cut & try process. The SSA is a true one-box solution that provides multiple signal source tests with the best performance and ease-of-use. As shown in Figure 20, the designers can verify frequency, power, DC current, phase noise, frequency/phase/power transients, and spurious (reference leak) - all with the SSA quickly and easily when designing a loop filter with different cut-off frequencies. The SSA also provides intuitive Windows-like operation to help the designers easily measure the desired parameters back and forth. As a result, the SSA allows the designers to optimize the cut & try process for signal source design and verification.

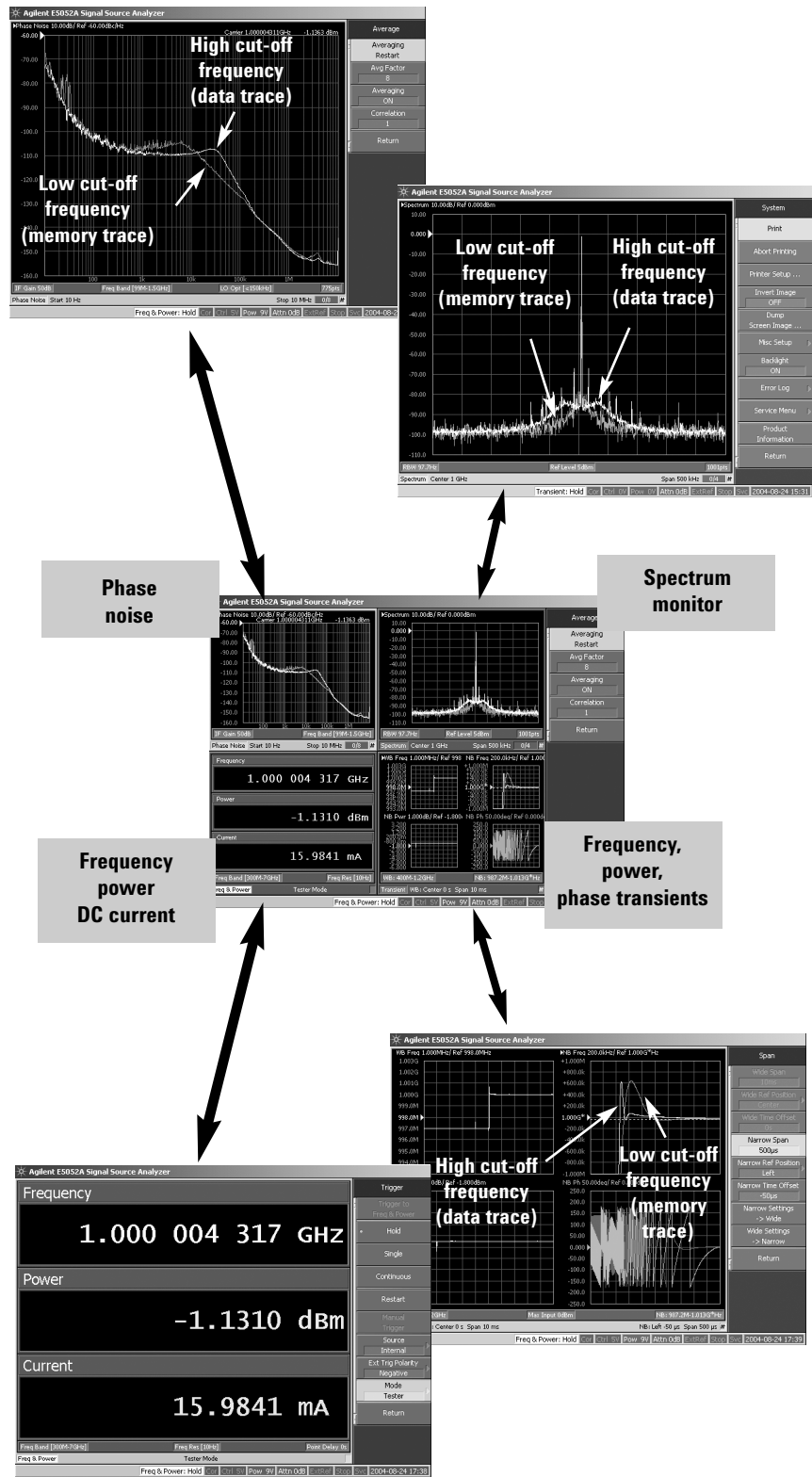

Figure 20. Cut & try optimization by the E5052A SSA (data trace: high cut-off frequency, memory trace: low cut-off frequency)

HINT 7. Utilizing Existing Downconverters for Frequency Extension

If the designers need to test microwave or millimeter-wave frequencies over 7 GHz, the E5052A SSA frequency coverage can be extended with the existing downconverters up to 26.5 GHz as shown in Figure 21. With an Agilent N5507A downconverter or 70427A downconverter, used in conjunction with an Agilent 11970 series harmonic mixer, the frequency can be extended up to 110 GHz.

By using the SSA's Visual Basic Application (VBA) feature, these downconverters can be fully controlled via the USB-GPIB interface. The test features supported by this configuration are frequency, including tuning sensitivity, and frequency pushing, DC current, phase noise, frequency and phase transient measurements as shown in Table 5.

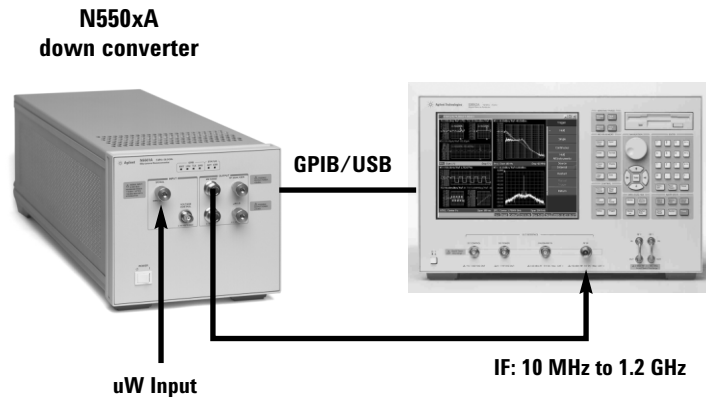

Figure 21. E5052A SSA with downconverter (Agilent 82357A USB/GPIB interface is required.)

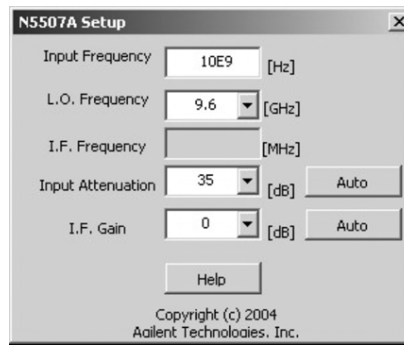

Figure 22. E5052A SSA VBA program example for downconverter control

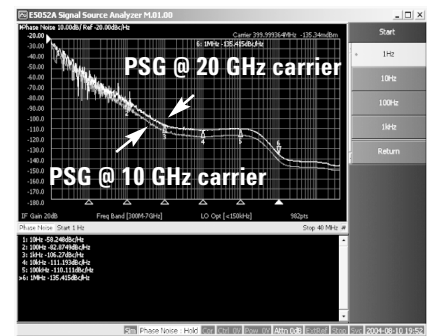

Figure 23. Phase noise measurement example of microwave source by E5052A SSA

Table 5. E5052A SSA test features and specifications with N550x downconverter

Key measurement item	Key specification with N5502A	Key specification with N5507A
Carrier frequency range	1 to 18 GHz	1.5 to 26.6 GHz
Measurement capabilities	Frequency versus control voltage or power voltage, DC current, phase noise, transient (frequency versus time, phase versus time)	
Input power range	+5 to +15 dBm (up to 12 GHz) +10 to +15 dBm (12 to 18 GHz)	-30 to +30 dBm
Phase noise sensitivity (Typical performance)	Carrier frequency = 12 to 18 GHz 38 dBc/Hz @ 1 Hz offset 64 dBc/Hz @ 10 Hz offset 81 dBc/Hz @ 100 Hz offset 109 dBc/Hz @ 1 kHz offset 121 dBc/Hz @ 10 kHz offset 131 dBc/Hz @ 100 kHz offset	Carrier frequency = 18 to 26.6 GHz 32 dBc/Hz @ 1 Hz offset 62 dBc/Hz @ 10 Hz offset 82 dBc/Hz @ 100 Hz offset 110 dBc/Hz @ 1 kHz offset 122 dBc/Hz @ 10 kHz offset 130 dBc/Hz @ 100 kHz offset
Transient measurement frequency range	1.6 or 25.6 MHz (narrowband mode, frequency and phase) 800 MHz max (wideband mode, frequency)	

Note: For additional specification details in conjunction with N550x series downconverters, please refer to the Agilent E5500A series phase noise measurement system configuration and performance guide (literature number 5988-9891EN).

To view, go to: <http://www.agilent.com/find/phasenoise>

Innovating Signal Source Design Process with E5052A SSA

Signal source analyzer (SSA) - an entirely new class of instrument

The traditional basic test instruments for signal source design and verification are very powerful and essential tools including a spectrum analyzer (SA), signal generator (SG), modulation domain analyzer (MDA), vector signal analyzer (VSA), etc. Each of these categorized products are very useful, although the designers always face a lot of technical issues and challenges as explained in "7 Hints" and as summarized in the Table 6 below.

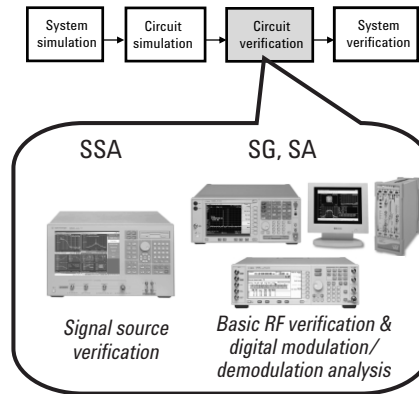

Figure 24. E5052A SSA - an entirely new class of instrument in the circuit verification stage

Table 6. Summary of "signal analyzers" for signal source measurements

Test instrument	E5052A SSA	Spectrum analyzer	Modulation domain analyzer	Vector signal analyzer	Phase noise test system
Supported test items	Frequency Power DC current Phase noise Transients Spurious Harmonics (DC Sources)	Frequency Power Spurious Harmonics Phase noise	Transients (Frequency, phase)	Frequency Power Transients Spurious Harmonics	Phase noise
Crystal oscillator	Best	Yes except phase noise	Yes for long-term stability	Yes except phase noise	Best
VCO, VCSO, DRO, YIG	Best	Yes except phase noise	N/A	Yes except phase noise	Yes
PLL frequency synthesizer	Best	Yes	Yes	Yes	Yes

The E5052A SSA is now available as an entirely new class of instrument that breaks the current measurement paradigm and innovates the signal source design process.

Thus, the SSA is now an essential tool for the designers along with the traditional test instruments as shown in Figure 24.



Agilent Email Updates

www.agilent.com/find/emailupdates

Get the latest information on the products and applications you select.

Windows is a U.S. registered trademark of Microsoft Corporation.

Related Literature

Agilent E5500A Series Phase Noise Measurement System, Configuration Guide, literature number 5988-9891EN

Agilent E5052A Signal Source Analyzer, Brochure, literature number 5989-0902EN

Agilent E5052A Signal Source Analyzer, Data Sheet, literature number 5989-0903EN

Web Resource

For more information on the Signal Source Analyzer, visit: www.agilent.com/find/ssa

Agilent Technologies' Test and Measurement Support, Services, and Assistance

Agilent Technologies aims to maximize the value you receive, while minimizing your risk and problems. We strive to ensure that you get the test and measurement capabilities you paid for and obtain the support you need. Our extensive support resources and services can help you choose the right Agilent products for your applications and apply them successfully. Every instrument and system we sell has a global warranty. Support is available for at least five years beyond the production life of the product. Two concepts underlie Agilent's overall support policy: "Our Promise" and "Your Advantage."

Our Promise

Our Promise means your Agilent test and measurement equipment will meet its advertised performance and functionality. When you are choosing new equipment, we will help you with product information, including realistic performance specifications and practical recommendations from experienced test engineers. When you receive your new Agilent equipment, we can help verify that it works properly and help with initial product operation.

Your Advantage

Your Advantage means that Agilent offers a wide range of additional expert test and measurement services, which you can purchase according to your unique technical and business needs. Solve problems efficiently and gain a competitive edge by contracting with us for calibration, extra-cost upgrades, out-of-warranty repairs, and onsite education and training, as well as design, system integration, project management, and other professional engineering services. Experienced Agilent engineers and technicians worldwide can help you maximize your productivity, optimize the return on investment of your Agilent instruments and systems, and obtain dependable measurement accuracy for the life of those products.

Agilent T&M Software and Connectivity

Agilent's Test and Measurement software and connectivity products, solutions and developer network allows you to take time out of connecting your instruments to your computer with tools based on PC standards, so you can focus on your tasks, not on your connections. Visit www.agilent.com/find/connectivity for more information.

For more information on Agilent Technologies' products, applications or services, please contact your local Agilent office. The complete list is available at:

www.agilent.com/find/contactus

Phone or Fax

United States:
(tel) 800 829 4444
(fax) 800 829 4433
Canada:
(tel) 877 894 4414
(fax) 800 746 4866
China:
(tel) 800 810 0189
(fax) 800 820 2816
Europe:
(tel) 31 20 547 2111
Japan:
(tel) (81) 426 56 7832
(fax) (81) 426 56 7840

Korea:
(tel) (080) 769 0800
(fax) (080)769 0900
Latin America:
(tel) (305) 269 7500
Taiwan:
(tel) 0800 047 866
(fax) 0800 286 331
Other Asia Pacific Countries:
(tel) (65) 6375 8100
(fax) (65) 6755 0042
Email: tm_ap@agilent.com

Product specifications and descriptions in this document subject to change without notice.

© Agilent Technologies, Inc. 2004
Printed in USA, September 21, 2004
5989-1618EN



Agilent Technologies