

# Impedance Measurements

## Evaluating EMC Components with DC Bias Superimposed

### Application Note

#### Table of Contents

Introduction.....	1
About Ferrite Beads .....	2
Impedance Measurements with a Vector Network Analyzer.....	4
E5071C ENA Network Analyzer .....	5
Sample VBA Program and Measurement Steps .....	5
Fixture Compensation .....	8
Measurement Results Under Actual Operating Conditions.....	11
Selecting Bias Tees.....	13
Summary.....	14

#### Introduction

Recent developments in semiconductor and communications technologies have accelerated the expansion of digital technology applications to more and more fields including home electronics and automotive parts and accessories.

Meanwhile, in order to cope with ever-increasing amounts of data, the demand for higher communication speeds has been increasing daily. In addition, developers are faced with stricter electromagnetic compatible (EMC) and noise control requirements and the increasingly complicated challenge of meeting today's standards and needs for power saving, low voltage design, smaller components, etc. EMC/noise control requirements will continue to become stricter and stricter.

Using ferrite beads as an example, this application note gives an overview on how to correctly evaluate EMC components in a way that satisfies these strict requirements. It also introduces various EMC measurement solutions.



## About Ferrite Beads

Figure 1 shows the equivalent circuit of a ferrite bead. Figure 2 shows the frequency characteristics of two different ferrite beads. Unlike ordinary inductors, Ferrite beads have high frequency components that are mainly resistive. Since resistive components absorb noise and turn it into heat, ferrite beads are primarily used to rectify signal waveforms or reduce high frequency noise in power or signal lines.



Figure 1. Equivalent circuit of a ferrite bead

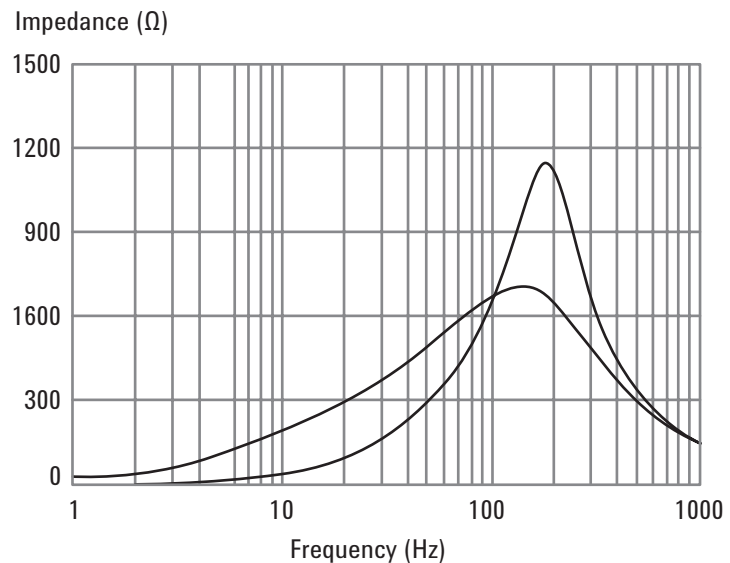

Figure 2. Examples of frequency characteristics of ferrite beads

When using ferrite beads, you should take the following precautions:

- 1) Clearly identify the differences in impedance characteristics. The two ferrite beads shown in Figure 2 have different impedance characteristics and therefore their signal rising edges are also different (as shown in Figure 3). Since the signal rising edge differs depending on the impedance characteristics, choosing between different ferrite beads requires careful consideration of not only their noise bandwidth, but also their impedance characteristics.
- 2) Pay attention to inductance saturation. Generally, core inductors such as ferrite beads have DC current dependencies as shown in Figure 4; the degree of inductance saturation differs depending on what material is used for the core of the component. This causes differences in impedance characteristics. Figure 5 shows how the impedance of a ferrite bead changes when superimposed with different DC currents. These impedance changes may cause a ferrite bead to exhibit a different noise removal effect or signal waveform than simulated. Therefore, to validate the effect of a ferrite bead, you have to identify its characteristics under actual operating conditions.

EMC/noise regulations have been expanding to cover ever higher frequencies including the GHz band. In addition, noise margins are decreasing due to a shift toward low voltage designs for electronic devices. Given these trends, there is increasing demand for ferrite beads with high frequency noise control; however, you cannot achieve effective noise control without identifying the impedance characteristics under actual operating conditions. The E5071C ENA network analyzer provides an effective solution for measuring the impedance of EMC components under actual operating conditions. With the E5071C ENA, which can measure up to GHz range, and the application of a DC bias current from an external DC source, measurements of EMC components under actual operating conditions can be achieved.

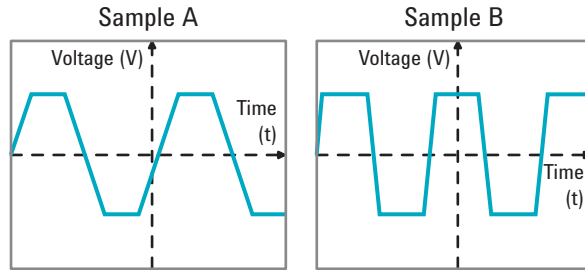

Figure 3. Different signal waveform rising edges resulting from different impedance characteristics (rough images)

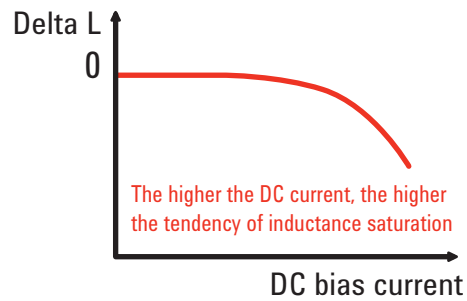

Figure 4. Inductance vs. DC bias currents

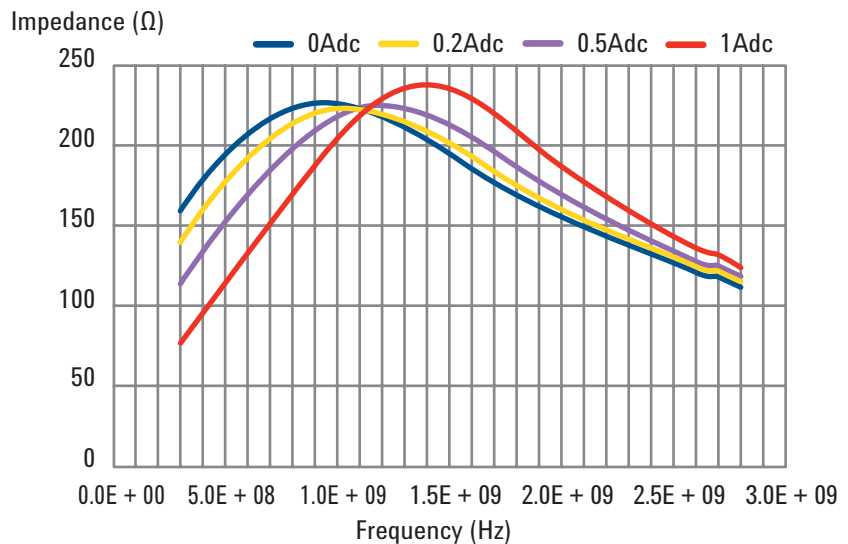

Figure 5. Comparison of ferrite bead impedance measurements with different DC bias currents superimposed

# Impedance Measurements with a Vector Network Analyzer

Two common methods used to perform impedance measurements with a vector network analyzer are the reflection method using one port and the shunt/series method using two ports. Figure 6 shows the relationships between the impedance and S parameter for each of the two measuring methods. When the impedance measured ( $Z_x$ ) is in the vicinity of the characteristic impedance ( $Z_0 = 50 \Omega$ ), the reflection method provides high-sensitivity measurements because the vector voltage ratio significantly changes with a small change in the impedance. However, when the impedance measured is not in the same vicinity as the characteristic impedance, the reflection method is not suitable due to trace noise.

The two port method allows you measure impedance over a wide impedance range using shunt/series connections. With the two port method, you can use either S11 or S21 to perform measurements; however, S11 has a more limited noise floor than S21, and it is highly susceptible to VSWR and other factors that exist between the fixture connector and substrate. Because of this, generally S21 is preferred. The S21 shunt connection is suitable for  $50 \Omega$  or lower impedances while the S21 series connection is suitable for  $50 \Omega$  or higher impedances. Because EMC components span a wide range of impedances depending on their purposes, their impedances must be measured with an adequate combination of S21 shunt/series connections.

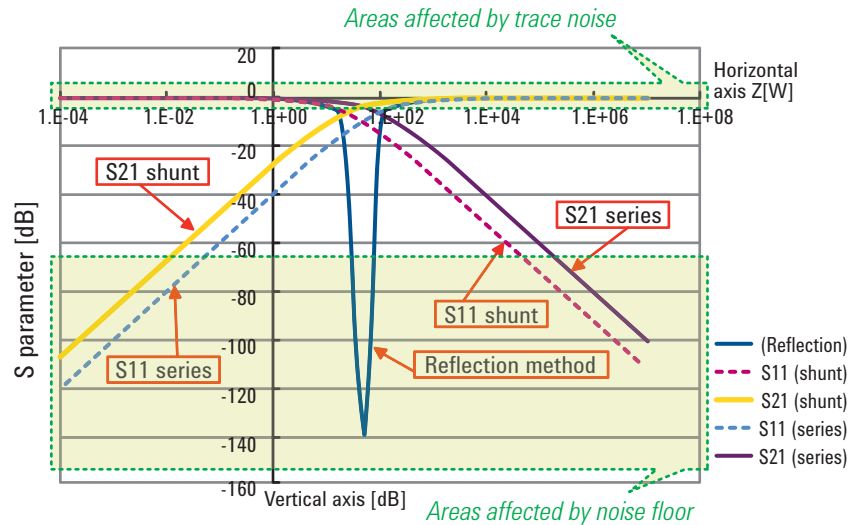
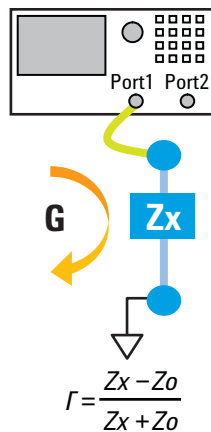

Figure 6. Relationship between impedance ( $Z$ ) and S parameter (dB) values

## One-port configuration (reflection)



## Two-port configuration (shunt/series through)

(If  $Z_0$  at ports 1 and 2 is  $50 \Omega$ )

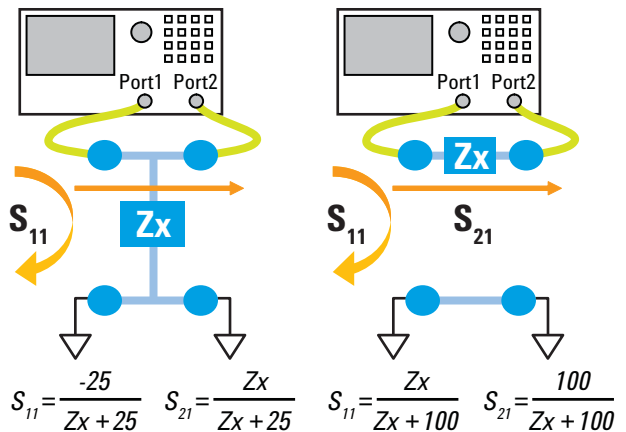

Figure 7. Measuring method and configuration of impedance measurements for a vector network analyzer

# E5071C ENA Network Analyzer

## Setup for DC bias superimposed impedance measurements under actual operating conditions

Figure 8 shows the basic setup for DC bias superimposed impedance measurements under actual operating conditions using the E5071C ENA network analyzer. In this setup, ports 1 and 2 are each connected with a bias tee. Each bias tee is connected to a DC power source and an electronic load. Ports used for measurement must be connected with bias tees to block DC signals from the analyzer. DC signals go from the DC power source to the bias tee, to the device under test (DUT), to the electronic load. Using an electronic load ensures that the DC bias applied to the DUT can be stably controlled. AC signals output from port 1 pass through the bias tee and the DUT, and are finally received by port 2. When AC signals pass through the DUT, they are superimposed on a DC bias.

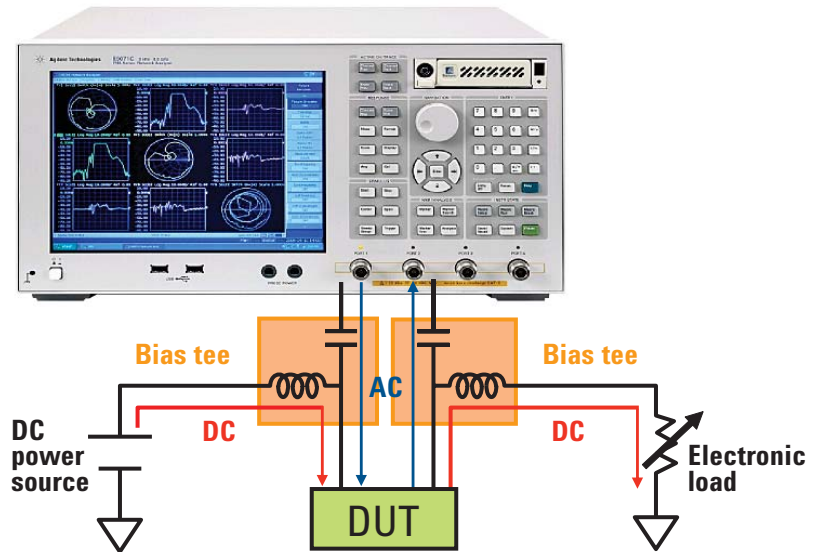

Figure 8. Measurement solution based on the E5071C ENA network analyzer

## Sample VBA Program

You can automatically control the system using the sample VBA program for the E5071C with the specified power source and electronic load. The program displays impedance measurement results of the different DC biases. The program works with the E5071C and supports the following power source and electronic load:

- Agilent E3633A/E3634A DC power source
- Agilent 3300A/E3301A electronic load

## Measurement Steps

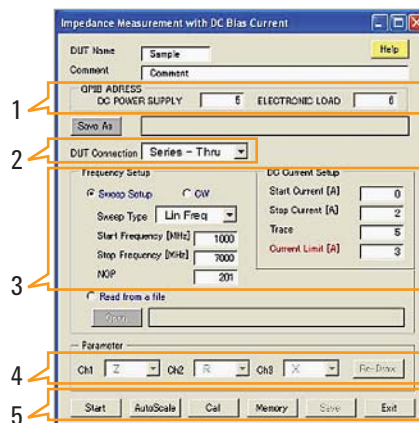

Figure 9. Main screen of the sample VBA program for the E5071C

Before starting the measuring process, copy the following two files into the VBA folder on drive D:

- Z\_DCI.VBA (sample VBA program)
- ZvsDCI.chm (help file)

Then, check the E5071C's **Channel/Trace Setup** to make sure that 9 channels and 9 traces are enabled. Press the **[MacroSetup]** button located in the INSTR STATE block on the front panel, and select **Load&Run**. Select "Z\_DCI" on the menu to open the main screen of the impedance VBA program.

To perform measurements using the sample VBA program, follow the steps listed below. The step numbers correspond to the numbers indicated on Figure 9. For detailed descriptions, click the **Help** button located on the upper right corner of the screen.

1. Set the GPIB addresses of the DC power source and electronic load. Be sure to enter the exact GPIB addresses specified for your DC power source and electronic load.
2. Specify the measurement method. This sample VBA program supports two-port shunt-through and series-through measuring modes.
3. Set the frequency and measurement conditions of the E5071C. On the **Sweep Type** drop-down list, select whether to sweep the frequency or DC bias current.

If you have selected frequency sweep:

- Click the **Sweep Setup** radio button. In the **Sweep Type** drop-down list, select either **Lin Freq** (linear sweep) or **Log Freq** (logarithmic sweep).
- In the **Start Frequency** and **Stop Frequency** fields, set the frequency sweep range.
- In the **NOP** field, specify the number of measuring points per trace.
- In the **IF Bandwidth** field, specify the IF bandwidth. The smaller the value, the more granular the measurements.
- In the **Start Current** and **Stop Current** fields, set the DC bias current to be applied.
- In the **Trace** field, specify the number of traces to be displayed. The DC bias current for each trace is automatically determined based on the settings specified in the Start Current and Stop Current fields. For example, if you configure the settings exactly as shown in Figure 10, five traces will be used from 0 A to 2 A, and the program will display the frequency characteristics superimposed with each of 0 A, 0.5 A, 1 A, 1.5 A, and 2 A DC bias currents.
- In the **Current Limit** field, specify the maximum allowable DC bias current. If this value is exceeded, the system will immediately terminate the measuring process.

Frequency Setup		DC Current Setup	
<input checked="" type="radio"/> Sweep Setup	<input type="radio"/> CW	Start Current [A]	0
Sweep Type: Lin Freq		Stop Current [A]	2
Start Frequency [MHz]	0.1	Trace (2 <sup>n</sup> )	5
Stop Frequency [MHz]	8500	Current Limit [A]	3
NOP (2 <sup>n</sup> 1601)	5		
IF Bandwidth [kHz]	70		

Figure 10: Setting up the frequency sweep

If you want to sweep the DC bias current. Click the **CW** radio button.

- In the **Frequency** field, specify the fixed frequency value.
- In the **IF Bandwidth** field, specify the IF bandwidth.
- In the **Start Frequency** and **Stop Frequency** fields, set the DC bias current sweep range.
- In the **NOP** field, specify the number of measuring points.
- In the **Current Limit** field, specify the maximum allowable DC bias current. If this value is exceeded, the system will immediately terminate the measuring process.

Frequency Setup		DC Current Setup	
<input type="radio"/> Sweep Setup	<input checked="" type="radio"/> CW	Start Current [A]	0
Frequency [MHz]	2800	Stop Current [A]	2
IF Bandwidth [kHz]	70	NOP (2 <sup>n</sup> 51)	5
		Current Limit [A]	3

Figure 11: Setting up the DC bias current sweep

4. Select your desired measurement parameters. The following parameters are available: Z,  $\theta$ , R, X, G, B, Ls, Lp, Cs, Cp, Rs, Rp, Q, D
5. Select **Cal** from the menu to perform cable and fixture calibration/compensation.

To perform the calibration:

Select the **Ecal** tab on the dialog box as shown in Figure 12. Connect the ECal module and click **Ecal**.

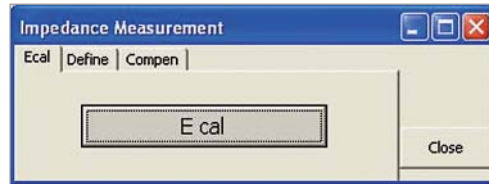

Figure 12: Calibration using Ecal

To perform the compensation measurement:

Select the **Define** tab on the dialog box as shown in Figure 13. Enter the defined values of the open and short standards you will use for compensation, and click the **Set** button.

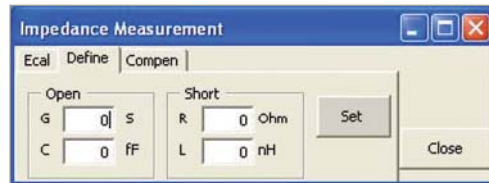

Figure 13: Entering the defined values

Then click and open the **Compen** tab (see Figure 14). Connect the open standard to both ports. Click the **PtExt** button to perform electrical length compensation. Then click the **Open** button to perform open compensation. Finally, connect the short standard to both ports, and click the **Short** button. When you are done, click the **Done** button. This completes the compensation process. Click the **Close** button.



Figure 14. Electrical length open/short compensation

Now the analyzer is ready to perform measurements. Click the **Start** button on the main menu to start the measuring process.

# Fixture Compensation

This section gives a description of fixture compensation. The fixture actually used for evaluation (Figures 15 and 16) has a pad for SMD placed in the center of the fixture and both ends are connected with SMA connectors. Fixtures have measurement errors resulting from error factors that exist between the calibration plane and the DUT measurement plane, as indicated in Figures 15 and 16. If you only perform a response calibration, you cannot correctly compensate for influences of the fixture because the response calibration does not account for the signal path that exists when a DUT is added. To correctly compensate for any error factors associated with the fixture, you should combine port extension and open/short compensation as outlined in this section.

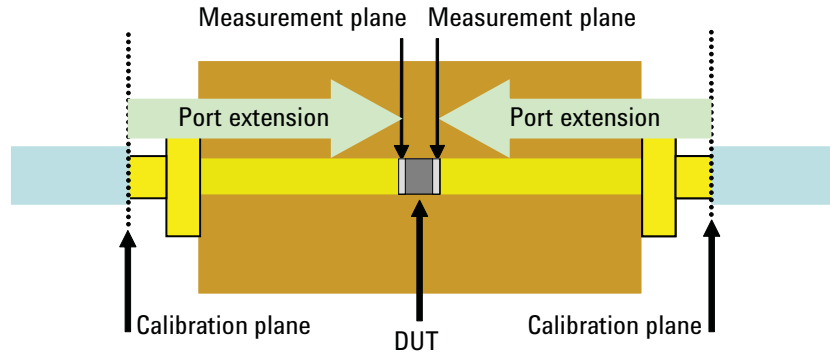

Figure 15. Series-through evaluation substrate

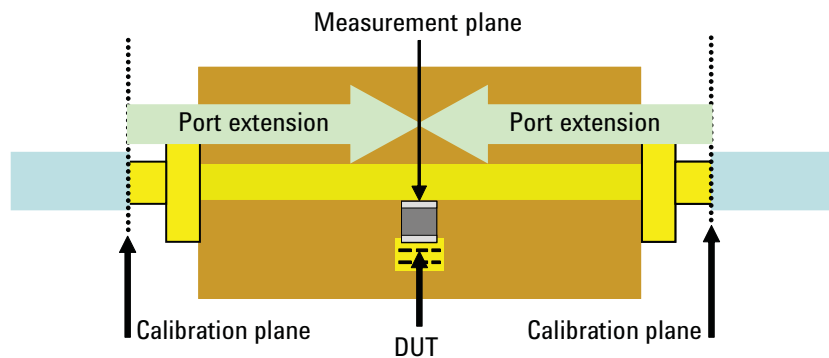

Figure 16. Shunt-through evaluation substrate

Figure 17 shows the fixture's error factors expressed by the electrical length and residual impedance. Although the actual measurements are performed using the two-port model, all measurements can be handled the same way as those obtained with the one-port model using an impedance analyzer because they are all expressed as impedances. You can use the port extension method to compensate for the electrical length from the calibration plane. For the fixture's residual impedance, you can use the open/short standards shown in Figures 18 and 19 to determine the admittance in the open state ( $Y_{open}$ ) and the impedance in the shorted state ( $Z_{short}$ ). Then, you can use Equation 1 on page 9 to determine the DUT's actual impedance by eliminating the fixture's residual impedance.

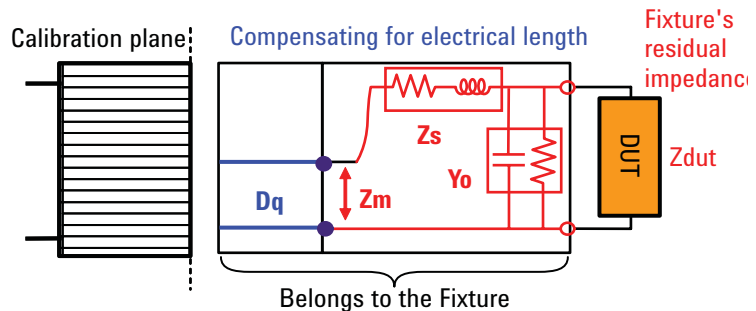

Figure 17. Fixture's error factors



$$Z_{dut} = \frac{Z_m - Z_s}{1 - (Z_m - Z_s)Y_o}$$

Equation 1. Compensation for errors using an open/short standard

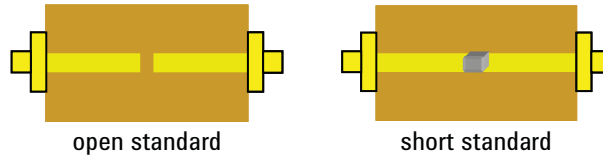

Figure 18. Standard for series-through evaluation

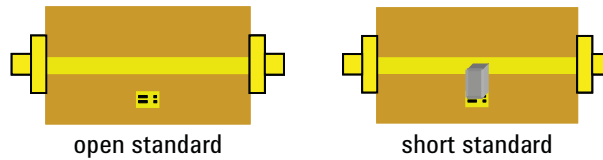

Figure 19. Standard for shunt-through evaluation

Figure 20 compares two sets of measurement results. One set was obtained by using the E5071C (with an IF bandwidth of 1 kHz) in conjunction with the fixture-based shunt-through and series-through connections and error compensation techniques described in this section, and the other by using the E4991A impedance analyzer in conjunction with a 16197A bottom electrode SMD test fixture. There is some error due to differences in fixture structure, but both sets of measurement results are almost the same. Also, even with DUTs whose impedances are 50 Ω or lower, good series-through correlations were attained by using a smaller IF bandwidth. However, the shunt-through connection has better measurement repeatability and is more suitable for measuring micro impedances of 0.1 Ω or lower (Figure 21). It is obvious that performing fixture compensation ensures good correlations between the measurements obtained using a two-port configuration with the E5071C network analyzer and those obtained using the E4991A impedance analyzer.

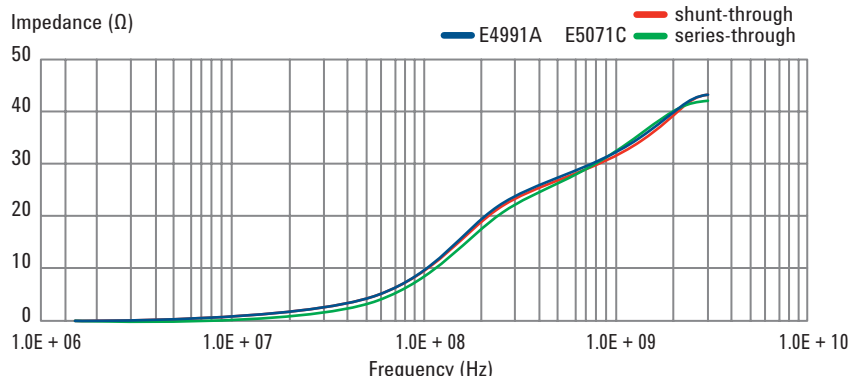

Figure 20. Comparison of ferrite bead measurements obtained using the E4991A and those obtained using the E5071C in the two-port configuration

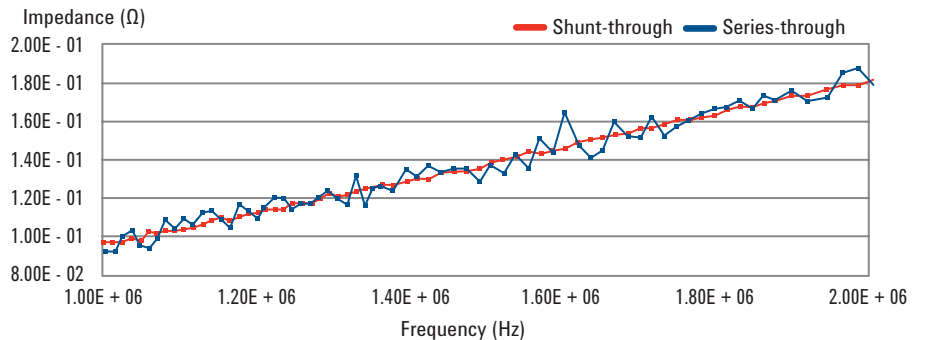

Figure 21. Comparison of shunt-through and series-through measurement repeatabilities

The rest of this section describes the benefits provided by compensation. Figure 22 compares measurement results (up to 6 GHz) obtained with and without short standard compensation. In the measurement results obtained without compensation, the impedance increases as the frequency increases because the fixture's inductance is not compensated for as residue in the shorted state. Figure 23 compares results of ferrite bead measurements (up to 6 GHz) obtained with and without compensation. In the measurement results without compensation, the DUT's impedance actually includes, as an offset, the fixture's residual impedance in the shorted state.

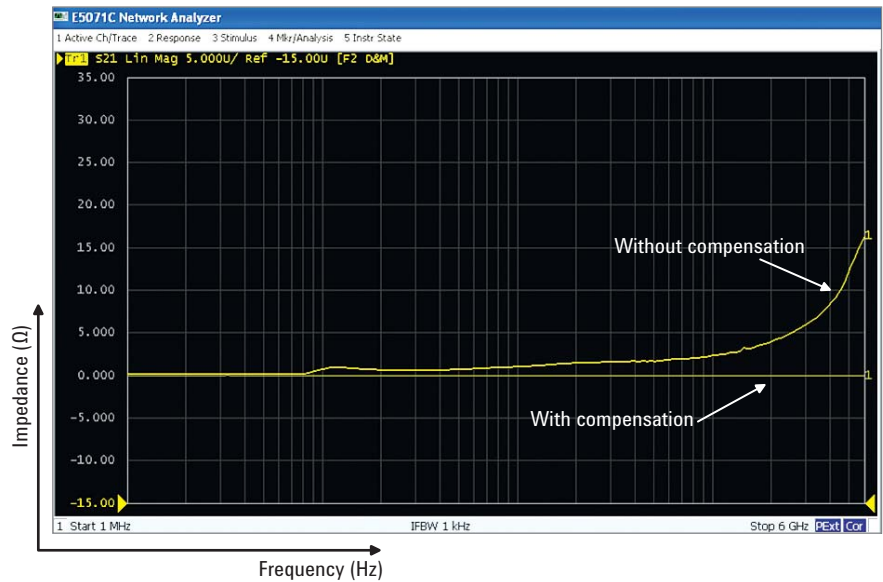

Figure 22. Comparison of measurement results obtained with and without short standard compensation

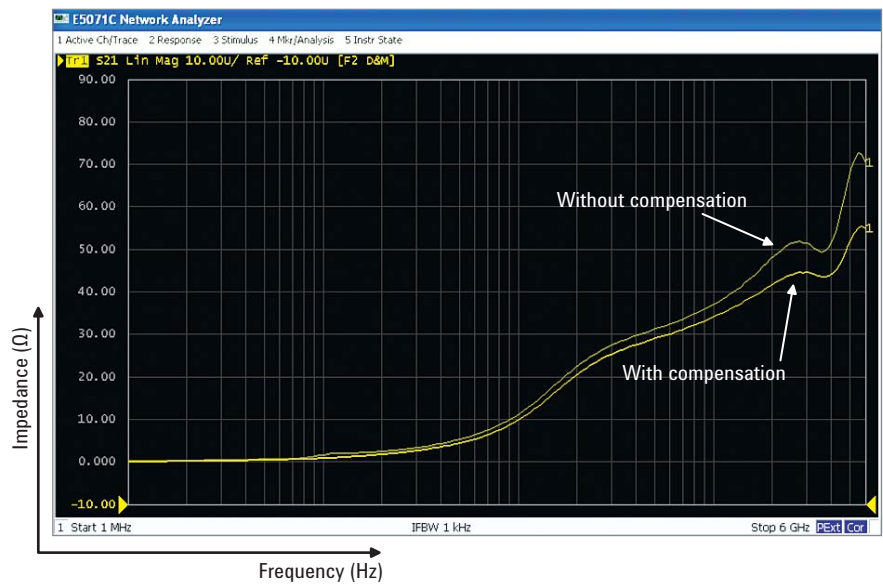

Figure 23. Comparison of ferrite bead measurement results

## Measurement Results Under Actual Operating Conditions

Figure 24 shows the results of a frequency sweep performed with a DC bias current applied to a ferrite bead in increments of 0.2 A. As shown, the impedance parameter changes as the DC bias current increases. You can also select a different set of measurement parameters. Figure 24 shows how the inductance (Ls) value changes during frequency sweep performed with a DC bias current applied in increments of 0.2 A.

Figure 25 shows the results of sweeping the DC bias current with a fixed frequency. You can evaluate the saturation characteristics of a ferrite bead by sweeping the DC bias current and verifying the reactance (X) and inductance (Ls).

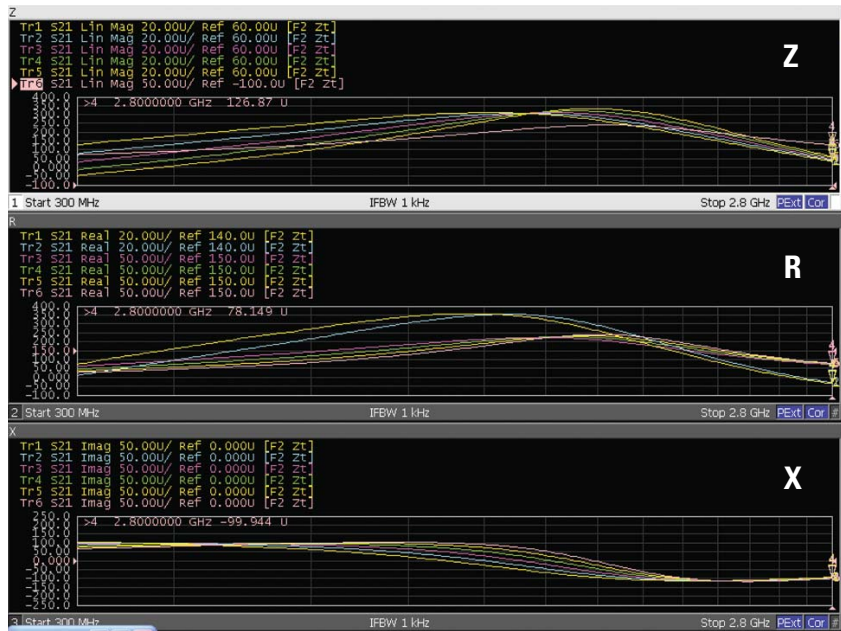

Figure 24. Frequency characteristics of a ferrite bead measured by changing the DC bias current in increments of 0.2 A (Z, R, X)

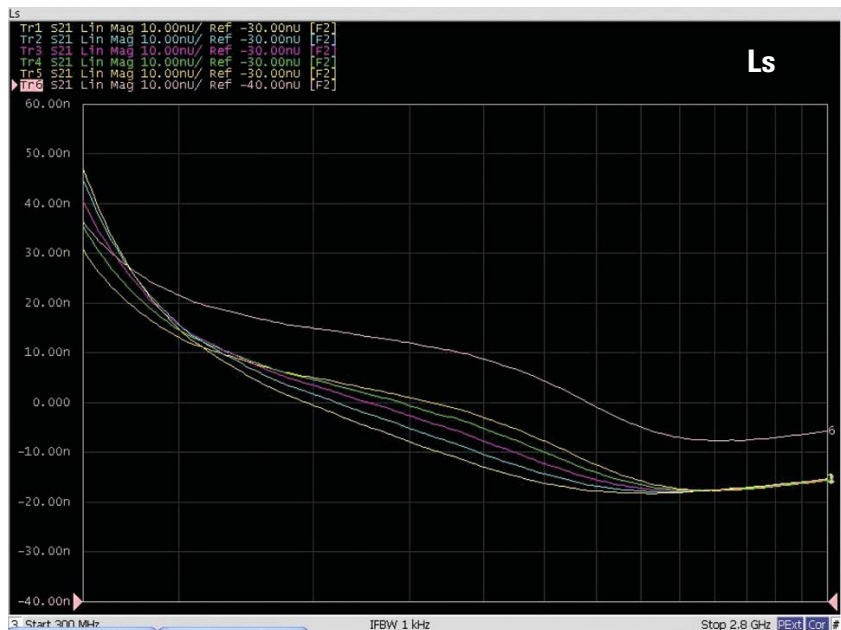

Figure 25. Frequency characteristics of a ferrite bead measured by changing the DC bias current in increments of 0.2 A (Ls)

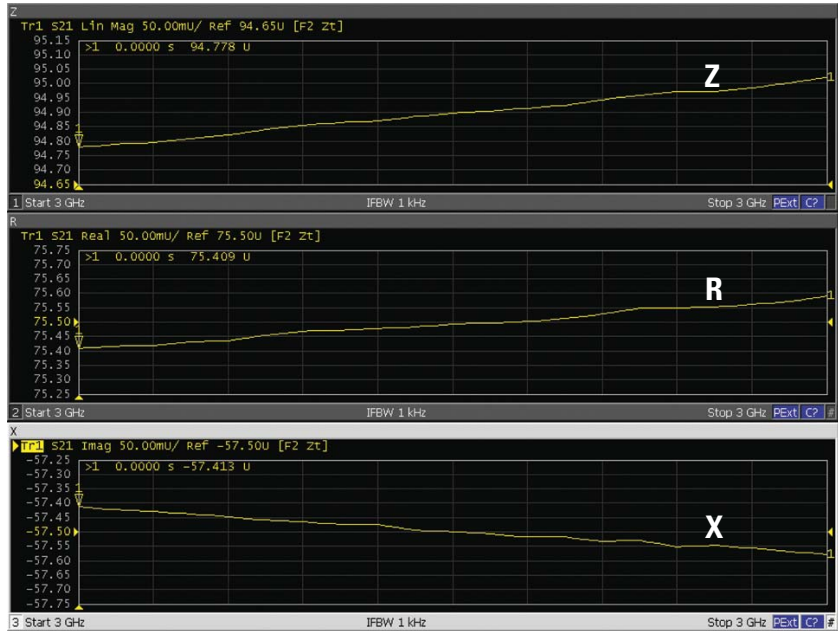

Figure 26. Ferrite bead measurement results obtained by sweeping the DC bias current with the frequency fixed

## Selecting Bias Tees

When selecting bias tees, consider the following parameters based on the device measurement conditions.

- 1) Bias-tee's frequency characteristics
- 2) Bias-tee's DC current dependency
- 3) Back electromotive force and analyzer protection

This section describes how to verify each of the above items using the bias tees actually used for the measurements in this application note. Table 1 defines the specifications of a bias tee.

Frequency range (IL 10 dB) (IL 15 dB)	0.3 – 2.8 GHz 0.45 – 2.6 GHz
Maximum DC current	7 A
Maximum DC voltage	100 V
Inductance	51 nH

Table 1. Bias tee specifications

## Bias tee's frequency characteristics

To identify the bias-tee frequency range suitable for your measurements, it is important to know, not only the  $-3$  dB cutoff frequency, but also the inductance region. Figure 27 compares bias-tee impedances and insertion losses. The inductance component of a bias tee contains fewer losses because the inductance provides an effect of blocking AC signal leakage to the bias tee's DC input terminal (see Figure 28). The linear inductance characteristics within the frequency range, included in the specifications above, are suitable for device measurements.

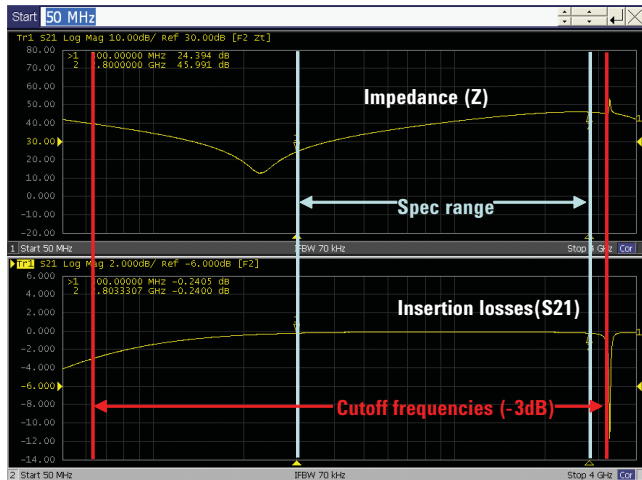

Figure 27. Frequency characteristics of a bias tee

## Bias-tee's DC current dependency

One of the prerequisites for correctly evaluating the DC current dependency of a device is that the bias tee (Figure 28) has a low enough DC current dependency under the specific measuring conditions. Figure 29 shows impedance representations of a bias tee's frequency characteristics measured by superimposing 0 A, 1 A, and 7 A DC bias currents. The fact that there are almost no changes in impedance within the frequency range included in the above specifications means that this bias tee has a small DC current dependency and is suitable for device evaluation.

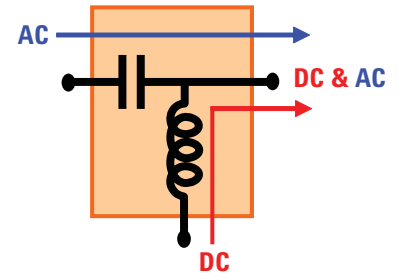

Figure 28. Bias tee

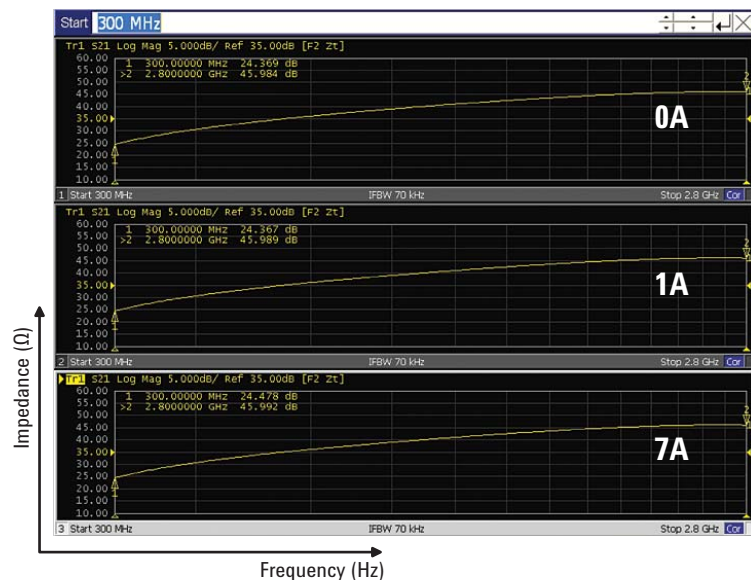

Figure 29. Bias tee's DC current dependency

## Back electromotive force and analyzer protection

When an instantaneous interruption of the analyzer occurs or when the device is detached during a measurement process, a back electromotive force can be generated that may result in damage to the analyzer. For example, if a 51 nH inductor is contained in the bias tee and 7A of DC current is applied to it, the inductor can generate a back electromotive force equivalent to  $1.25 \times 10^{-6}$  (V) (see Equation 2 below). Similarly, an inductor contained in a device can generate a back electromotive force. You should check the back electromotive forces and voltage endurance specifications of the bias tee and device in advance. Also, avoid any operations that can cause an instantaneous interruption, and be sure to set the DC bias current down to 0 A before turning off the power to the analyzer.

### **Back electromotive force**

$$(V) = LI^2/2$$

*Equation 2. Calculating the back electromotive force*

## Summary

EMC/noise control requirements will become stricter and stricter. Using ferrite beads as an example, this application note has given an overview on how to correctly evaluate EMC (electromagnetic compatible) components to satisfy these strict requirements. It also introduced you to some other available measurement solutions.

The impedance characteristics of EMC components change when the DC bias changes; therefore, you cannot achieve effective EMC/noise control without evaluations under actual operating conditions. Also, given the accelerating trends towards higher speeds, it is now necessary to perform impedance evaluations in the GHz band. Performing EMC component evaluations using a vector network analyzer under actual operating conditions is a very effective solution to these issues. The sample VBA program for the E5071C network analyzer allows you to automatically control the power source and electronic load and to easily perform impedance evaluations of EMC components under actual operating conditions.

 **Agilent Email Updates**

[www.agilent.com/find/emailupdates](http://www.agilent.com/find/emailupdates)  
Get the latest information on the products and applications you select.

 **Agilent Direct**

[www.agilent.com/find/agilentdirect](http://www.agilent.com/find/agilentdirect)  
Quickly choose and use your test equipment solutions with confidence.

Agilent  
Open 

[www.agilent.com/find/open](http://www.agilent.com/find/open)  
Agilent Open simplifies the process of connecting and programming test systems to help engineers design, validate and manufacture electronic products. Agilent offers open connectivity for a broad range of system-ready instruments, open industry software, PC-standard I/O and global support, which are combined to more easily integrate test system development.

## Remove all doubt

Our repair and calibration services will get your equipment back to you, performing like new, when promised. You will get full value out of your Agilent equipment throughout its lifetime. Your equipment will be serviced by Agilent-trained technicians using the latest factory calibration procedures, automated repair diagnostics and genuine parts. You will always have the utmost confidence in your measurements. For information regarding self maintenance of this product, please contact your Agilent office.

Agilent offers a wide range of additional expert test and measurement services for your equipment, including initial start-up assistance, onsite education and training, as well as design, system integration, and project management.

For more information on repair and calibration services, go to:

[www.agilent.com/find/removealldoubt](http://www.agilent.com/find/removealldoubt)

Product specifications and descriptions in this document subject to change without notice.

For more information on Agilent Technologies' products, applications or services, please contact your local Agilent office. The complete list is available at:

[www.agilent.com/find/contactus](http://www.agilent.com/find/contactus)

### Americas

Canada	(877) 894-4414
Latin America	305 269 7500
United States	(800) 829-4444

### Asia Pacific

Australia	1 800 629 485
China	800 810 0189
Hong Kong	800 938 693
India	1 800 112 929
Japan	0120 (421) 345
Korea	080 769 0800
Malaysia	1 800 888 848
Singapore	1 800 375 8100
Taiwan	0800 047 866
Thailand	1 800 226 008

### Europe & Middle East

Austria	01 36027 71571
Belgium	32 (0) 2 404 93 40
Denmark	45 70 13 15 15
Finland	358 (0) 10 855 2100
France	0825 010 700*
	*0.125 €/minute
Germany	07031 464 6333
Ireland	1890 924 204
Israel	972-3-9288-504/544
Italy	39 02 92 60 8484
Netherlands	31 (0) 20 547 2111
Spain	34 (91) 631 3300
Sweden	0200-88 22 55
Switzerland	0800 80 53 53
United Kingdom	44 (0) 118 9276201

Other European Countries:

[www.agilent.com/find/contactus](http://www.agilent.com/find/contactus)

Revised: October 6, 2008

© Agilent Technologies, Inc. 2009  
Printed in USA, February 3, 2009  
5989-9887EN



**Agilent Technologies**