

Keysight Technologies

Radar, EW & ELINT Testing: Identifying Common Test Challenges

Application Note



Introduction

The roots of modern radar systems stretch back to 1940 when the U.S. Navy developed what was then called radio detection and ranging or RADAR. Today, this technology has been adapted to applications that range from the ubiquitous supermarket door opener, which is a simple moving-target indicator (MTI), to highly complex shipboard phased-array fire-control radars.

In military applications, two new fields followed close on the heels of radar: electronic intelligence (ELINT) and electronic warfare (EW). ELINT is used to extract information from enemy radar systems and provide insights into coping with potential threats attached to those radar signals: ships, aircraft, missiles, and so on. The associated development of EW technologies provides active and passive responses to those potential threats.

From the simplest to the most complex, all radar, EW and ELINT systems pose a variety of challenges when it comes time to test components, assemblies and systems. To complicate matters, all radars operate in an increasingly cluttered spectral environment. For example, the airwaves in an urban setting may include countless wideband RF and microwave emitters—and therefore potential interferers—such as wireless communications infrastructure, wireless networking systems and civilian radars.

This application note focuses on test equipment that will help you address the challenges you're most likely to face during system development. To provide context, the note starts with a review of radar, EW and ELINT basics. After providing an overview of key test challenges, the remainder of this note covers three main topics: the generation of test signals, an example of a synthetic test range, and the validation and analysis of radar signals.

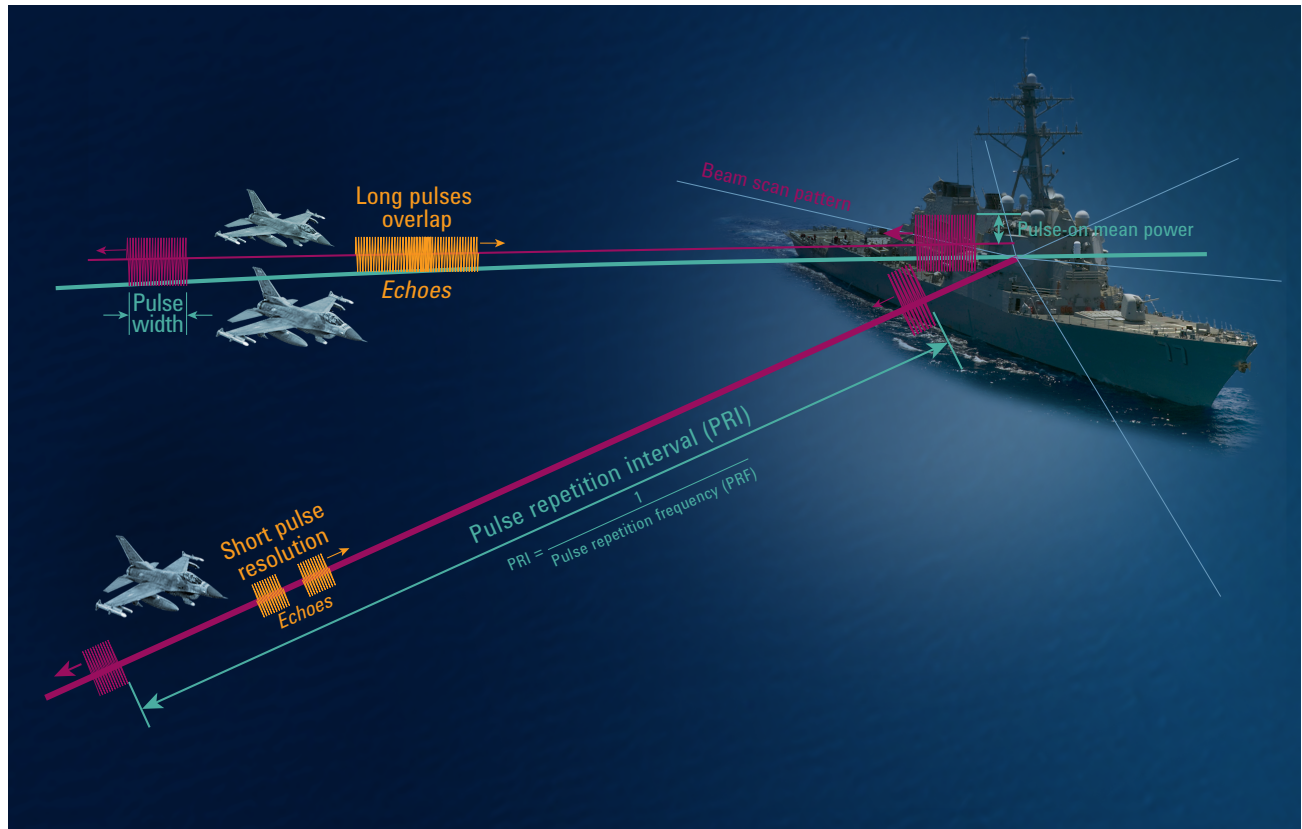

Figure 1. Radar pulse terminology and tradeoffs

Primary radars suffer significant signal losses from the transmitted pulse to the received echo. The transmitted signal must bounce off and travel back from the target to the receiver without amplification. One way to overcome these large signal losses is to transmit longer pulses and integrate the larger total energy in the received echo. A longer pulse width thus provides longer operating range for a given antenna and transmit power amplifier.

Radar “resolution” is also an important characteristic related to pulse width. The ability to resolve small objects allows a radar to provide a more detailed picture of the target. A radar that can resolve details down to 1 meter will provide much more information about approaching targets. A resolution of 100 meters might render

one large target indistinguishable from several smaller ones in close formation.

If a radar’s pulse width is long, echoes from adjacent targets can bounce back together, overlapping in time. To the radar, this appears as one large target instead of adjacent smaller targets. Thus, to get the best radar resolution, a narrower pulse width is desirable.

One can see that optimal range and resolution involves conflicting criteria. Best range implies a long pulse whereas best resolution implies a short pulse.

To solve the range-versus-resolution optimization problem, many radar systems use pulse compression or modulation. The linear frequency

chirp is, in concept, a simple modulation to create and to decompress. Frequency modulating (FM) the radar pulse with a linear voltage ramp creates a frequency-chirped pulse. The chirped pulse is then transmitted, as an uncompressed pulse would normally be.

The radar receiver uses a special filter with a significant linear group delay opposite that of the chirped pulse. The filter’s group delay slows the lower-frequency portion of the chirp and allows the higher-frequency part of the chirp to emerge from the filter earlier. This has the effect of taking a long pulse, easily integrated for greater total power, and compressing it to a short pulse easily identified among other pulses.

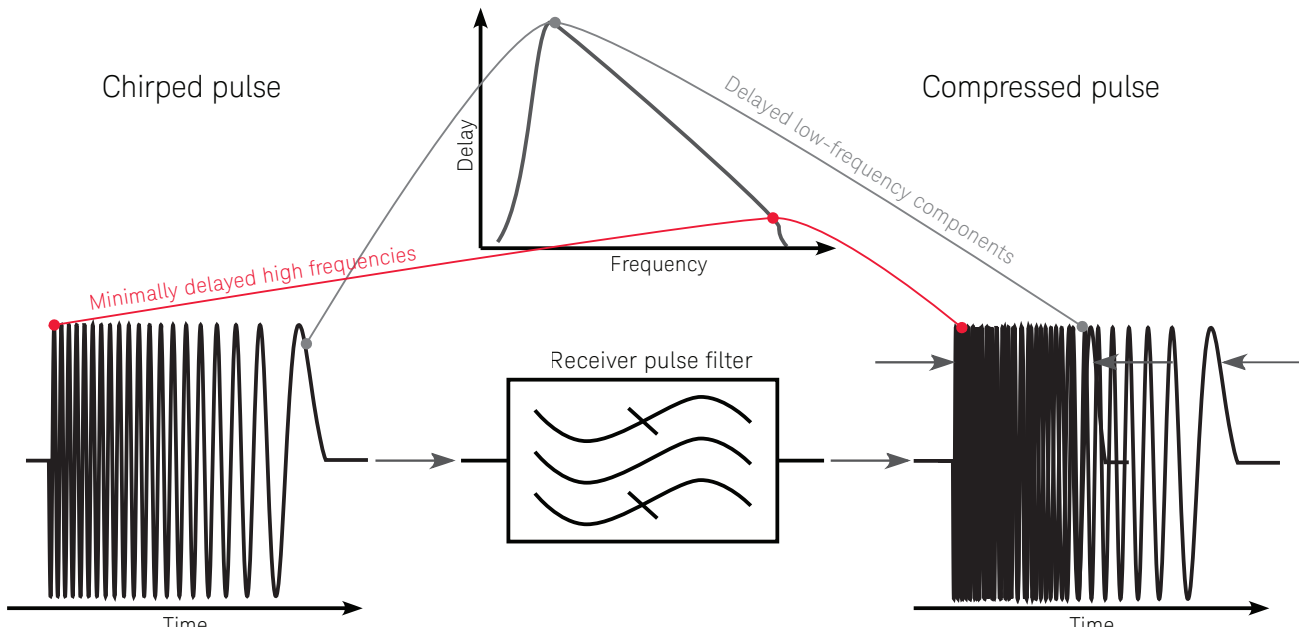

Figure 2. Frequency chirped pulse compression

Pulse compression or modulation offers other advantages in unambiguous range. To see these advantages, let us consider the pulse repetition frequency.

The pulse-repetition frequency (PRF) is dependent on the range capability of the radar. Sending new pulses out before previously sent pulses can echo back can cause an ambiguity in the echo response. Generally, it is easiest to send a pulse out and wait until all possible echo responses have been received before sending the next pulse. Providing an unambiguous range response determines the PRF or pulse-repetition interval (PRI) between successive pulses.

There are many cases, however, in which a slower PRF degrades overall radar performance. For example, it might be preferable to have a higher PRF for a faster radar screen update rate if the radar is tracking a fast moving aircraft. In this case, the PRF might allow an ambiguous return in favor of a faster update rate.

One approach to eliminating the clutter of echoing returns that are not from a range of interest is to use time or range gating. This approach blanks on or off the radar's receiver, ignoring echoes from objects either too close or beyond the range of interest. An example might be a time gate that ignores echoes from the bow of the ship the radar is mounted on. Similarly, a missile might use time gating to ignore echo returns beyond the missile's maximum range.

As mentioned earlier, pulse compression can be used to eliminate ambiguity between successive pulses. Adding digital modulation to each pulse allows the adjacent pulses to be uniquely encoded. Using digital modulation techniques, such as bi-phase keying, encodes pulses so the round trip delay of each pulse is easily measured unambiguously using each pulse's unique coding as a separating tool.

Another important feature of many radars is the ability to measure Doppler shift from moving targets. Measuring the change in frequency of the RF carrier or phase shift with time allows some radars to accurately determine the target's speed. MTIs use Doppler shift in the return echo to sense movement.



Figure 3. Time gating or range gating

ELINT/EW basics – What’s out there?

The various design criteria that influence the chosen radar pulse pattern also convey a great deal of information about the nature of the platform attached to the radar. A slow PRF with a long pulse might indicate a weather radar scanning across hundreds of miles, where a fast PRF and a short pulse width might indicate a missile’s terminal homing radar scanning across a mile or two. The ELINT gained from these signals conveys vastly different information.

Similarly, the scan pattern of the radar can also convey valuable information about threats in the local environment. For example, observing the signal amplitude as a function of time can reveal the type of antenna the radar is scanning with and the pattern the antenna is scanning out. This type of intelligence is helpful for understanding what the radar is illuminating and how it is being used.

Beyond simply gathering ELINT information about the radar and its attached platform, knowledge about the radar can enhance and guide electronic warfare techniques. For example, echo patterns can be synthesized and broadcasted to an early warning radar receiver to display assets that are physically not there. Missiles can track false radar returns that alter their range gating to ignore their intended targets. Doppler information can also be used to confuse targeting equipment.

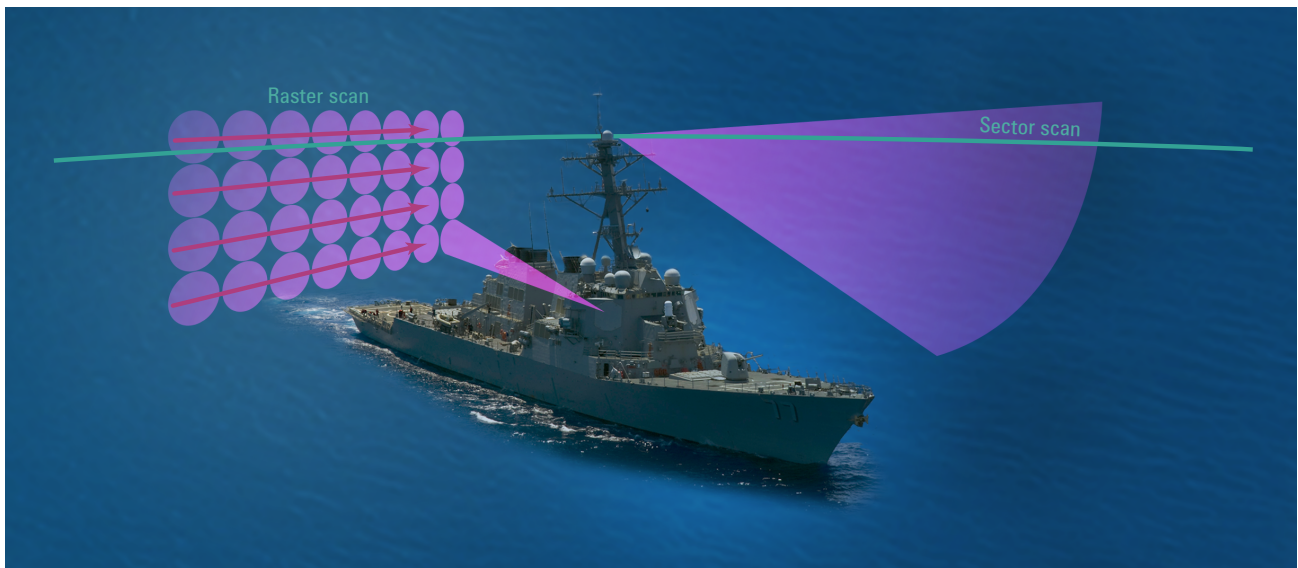

Figure 4. Antenna scan patterns

Modern radar & EW test challenges

The above review of some of the design issues with radar, ELINT and EW equipment highlights the level of circuit complexity required. Testing these modern radar systems places unique demands on test and measurement equipment. Let us briefly consider some common challenges encountered in testing.

Wide bandwidths are essential for many radar signals. Chirped or modulated pulses can require gigahertz of bandwidth, demanding broadband test equipment resources.

Very low phase noise is another common requirement of radar test equipment. Radars that use Doppler shift information often measure the rate of phase shift over time, as radar pulses may not be long enough to integrate cycles of frequency difference. When making these precise phase-change measurements, phase noise must be kept very low, placing stringent requirements on the phase-noise performance of the test instrumentation.

Similarly, dynamic range requirements can challenge radar test systems. Generally, this stems from the large path losses encountered from the transmitter through the return echo.

As we have seen thus far, the many advantages of using compressed pulses for better resolution and unambiguous range frequently give rise to the need for complex test waveform synthesis. This can be further compounded by the need for added Doppler shifts for radars that determine velocity.

Another challenge facing radar system designers is the ubiquitous use of software-defined radar systems. Many modern types of radar not only require test signals and measurements in the traditional analog RF fashion, but also in digital formats. This multi-format testing can present a real problem trying to get good agreement between digital signal measurements and analog measurements.

Full-scale system test is often a major issue for radar, ELINT and EW equipment. The primary issue is usually the cost of the test assets. For example, simulating Doppler shifts, clutter and other signal elements to test a shipboard fire-control radar may require a ship and multiple test aircraft. Such test platforms can quickly run into a cost of many tens of thousands of dollars per hour to accurately test targeting performance.

Finally, many radars use phased-array antenna systems. These systems use wavefront time-of-arrival among many antenna ports to steer the antenna beam. This calls for test signals and measurements that provide multiple channels of phase-coherent and phase-adjustable sources or analyzers. The so-called multi-channel array test system poses some very real challenges to the radar test engineer.

Having examined some of the basics of radar systems and the test challenges they pose, next we will look at the unique features of the Keysight Technologies, Inc. test equipment that make some of the radar engineer's difficult test challenges much easier to solve. We begin with the generation of radar test signals.

Generating Test Signals

In the design and manufacture of radar systems, many situations require wideband microwave signal generators. Test signal sources are commonly used for applications such as stable local oscillator (STALO) substitution, coherent oscillator (COHO) testing and threat-emitter simulation.

Creating an accurate simulation of received signals can be quite difficult. Fortunately, today's DSP-based signal generators and arbitrary waveform generators (AWGs) are capable of producing simulated emitter signals and electromagnetic environments with realistic impairments and path distortions that accurately portray distant targets. One important note: With COTS signal generators and AWGs, the simulated signals are typically not coherent with the radar receiver. However, non-coherent signals are an effective way to test passive radar, multi-static radar and electronic countermeasure (ECM) systems.

Keysight signal sources and AWGs

The true power of an AWG is in its ability to generate virtually any waveform downloaded into its memory. For example, an AWG that can provide both high resolution and wide bandwidth—simultaneously—makes it easy to create radar emitters and targets scattered across a synthetic test range that simulates hundreds of cubic miles of airspace.

In the past, bandwidth was a crucial limitation of most AWGs. Today, the latest models have largely solved this problem for many applications. For example, the M8190A AWG provides 14-bit resolution up to 8 GSa/s and 12-bit resolution up to 12 GSa/s. This makes it possible to generate signals with alias-free bandwidths of up to 5 GHz. Even greater alias-free bandwidths can be created through the use of combining and converting technologies.

When selecting an AWG, perhaps the most important consideration is the spurious-free dynamic range (SFDR) of the source. This is affected by the bits of resolution provided by the digital-to-analog converter (DAC) within the AWG. It also depends on the quality of the frequency-conversion circuitry that translates the arbitrary signal into the microwave range.

Theoretically, each bit of resolution should yield a maximum of 6.02 dB of SFDR. In practice, DACs are often described in terms of the effective number of bits (ENOB) or an equivalent number of bits. After accounting for linearity issues, the actual SFDR per bit is less than the theoretical 6.02 dB.

Broadband DACs also suffer from a phenomenon called passband tilt, which further lessens dynamic range at the higher end of the frequency band. Also, due to the $(\sin x)/x$ rolloff of the sampling function, passbands from the AWG roll off as frequency increases; however, because this tilt is inherent in the sampling function, it is not considered when specifying SFDR. Thus, an SFDR of 75 dB generally applies to the lowest frequency in the band. Dynamic range will typically be 5 to 7 dB lower at the upper end of the band.



Figure 5. Keysight arbitrary waveform instruments

Generating Test Signals (continued)

In addition to the number of bits and the SFDR loss related to the sampling function, upconversion to microwave frequencies poses another set of problems in the creation of useful signals. Upconversion can be performed within the signal source or externally with a separate device. This may seem easy to do using just a mixer, two filters and a fixed LO. In practice, however, LO harmonics and spurs often combine with the desired signal to create in-band spurious signals that can severely limit SFDR.

Many radars measure pulse-to-pulse phase shifts as a way to derive values for Doppler shift or target velocity. To combat the addition of unwanted phase noise into the upconversion process, a signal generator must also have low phase noise.

Keysight offers a full line of signal sources and AWGs that offer excellent SFDR and phase noise performance. For example, the E8257D PSG analog signal generator offers industry-leading phase noise performance as good as -143 dBc/Hz (typical) for a 1 GHz signal at a 10 kHz offset (option UNY). For upconversion, the analog PSG can also be configured with an internal mixer or an internal mixer and frequency doubler.

The E8267D PSG microwave vector signal generator offers I/Q modulation inputs and frequency coverage up to 44 GHz (and higher with external mixers). The modulation inputs are compatible with the M8190A AWG. Working together, these two high-performance instruments can deliver 2 GHz of signal bandwidth up to 44 GHz with excellent SFDR and phase noise.

Another way to mitigate many of these issues is digital upconversion, which is offered in the best of today's AWGs. When available in a wide-bandwidth AWG, this technique makes it possible to directly generate the IF signal. In the two-channel M8190A, each channel has a separate digital upconversion engine and the channels can be used in "coupled mode" to achieve full phase-coherent output. Parameters such as carrier frequency, amplitude and waveform can be set independently and the complex-valued I and Q data will be upconverted digitally to the desired frequency range while providing excellent signal quality with SFDR of up to 80 dBc and harmonic distortion of less than 72 dBc (both values are typical).

Memory configuration is another important consideration when selecting an AWG or a vector signal generator with AWG capabilities. Either type of instrument creates waveforms by playing back digital information from memory. The addition of standard or optional capabilities for sequencing and playback can further enhance the utility of the signal generator.

The simplest way to organize playback memory is to use a single large block of fast RAM and play the waveform directly from memory. This works well for single pulses or very short RF events; however, at the data rates required to support 12 GSa/s at 12-bit resolution, the signal must be very short. Some manufacturers have extended this approach to work with large RAID arrays, thereby enabling longer playback times.¹

The single-block approach is of somewhat limited usefulness because most RF signals are repetitive. Even with terabytes of memory or RAID capacity, sequential playback times will be limited to a few seconds of signal.

1. RAID: redundant array of inexpensive discs

Generating Test Signals (continued)

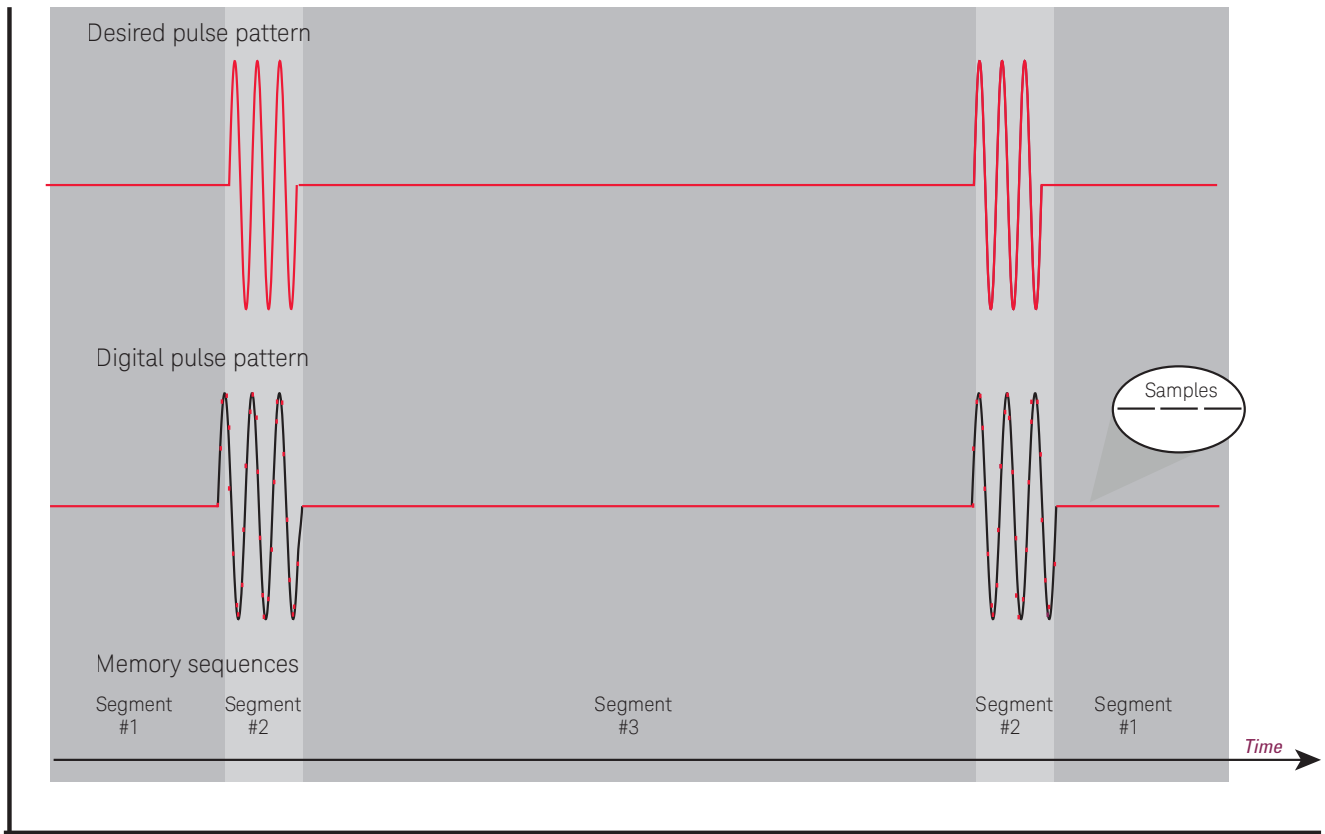

Figure 6. Waveform segmenting, sequencing and scenarios

The solution is a more efficient memory-access capability for repetitive signals such as radar pulse sequences. To support a repetitive signal, fast playback memory can be organized to play signal segments as loops or an infinite sequence. Advanced sequencing capabilities such as conditional branching make it possible to create highly complex segments and scenarios. In addition, some Keysight sources offer dynamic sequencing that supports real-time modification of waveform segments. When combined with waveform memory large enough to hold 2 GSa per AWG output channel (M8190A), highly complex and realistic signal scenarios of long duration are possible.

Once you've chosen a signal source that provides adequate bandwidth, SFDR, phase noise and sequencing capabilities, the next challenge is the digital creation of the desired waveform using software tools such as Signal Studio or SystemVue from Keysight or MATLAB from The MathWorks.

Generating Test Signals (continued)

Key features:

Signal Studio for Pulse Building

This specialized version of Signal Studio (N7620B) supports a wide array of imported or software-defined pulse shapes and antenna patterns.

Pulse parameters

- Rise and fall times
- Edge shape
- Jitter
- Pulse width pattern
- Modulation-on-pulse

Pattern parameters

- Number of pulse repetitions
- Pulse repetition interval (PRI) or pulse repetition frequency (PRF)
 - PRI patterns: bursted, linear ramp, staggered, stepped
 - PRI jitter: Gaussian, uniform or U-shaped
 - PRI wobulation: sawtooth, sinusoidal, triangular
- Amplitude scaling
- Frequency offset
- Phase offset
- Additional off time

Modulation-on-pulse

- AM step
- Barker codes (seven types)
- BPSK and custom BPSK
- FM chirp (linear or nonlinear)
- QPSK and custom QPSK
- Polyphase codes

Antenna scanning patterns

- Circular
- Conical
- Custom
- Bidirectional raster
- Unidirectional raster
- Bidirectional sector
- Unidirectional sector

Antenna radiation patterns

- Rectangular
- Cosine (five variations)
- Blackman and exact Blackman
- Hamming
- Three-term
- User-defined

Easy pulse building for Keysight sources

Depending on the application, pulsed radar signals utilize a wide range of characteristics: pulse width; PRI or its inverse, PRF; modulation; and more. The creation of suitable test signals is challenging, and the synthesis of pulsed test signals is further complicated by the desired system diagnostics: Doppler shift or pulse-to-pulse phase shift may be needed to test velocity measurement capabilities, and simulation of antenna scanning patterns may be needed to test an ELINT system. To meet these needs, software tools must support numerous pulse patterns for signal creation and provide a wide variety of antenna characteristics that can be applied to synthesized signals.

To address these needs, Keysight has created Signal Studio for Pulse Building (N7620B). This software provides an easy way to enter a variety of pulse characteristics and create signals that range from simple on-off pulses to complex custom compressed pulses.

For testing of radar components, transmitters or receivers, Signal Studio for Pulse Building lets you

specify parameters such as PRI, the number of pulse repetitions, repetition interval jitter and PRI wobulation. Available PRI patterns include bursted, linear ramp, staggered and stepped, and PRI jitter can be defined as Gaussian, uniform or U-shaped. PRI wobulation can be selected as sawtooth, sinusoidal and triangular. These capabilities enable a variety of receiver tests:

- Test system response to impairments by creating pulse-width patterns with jitter
- Test range gating and range/Doppler ambiguity resolution with complex PRI patterns
- Test MTI modes and Doppler processing by adding frequency and phase offsets
- Test clutter rejection performance by creating custom pulses with clutter

Each pulse definition stored in the library can be aggregated into pulse patterns and then synthesized as complex sets of radar emissions. Once the pulse parameters have been entered, the next step is to download the waveform to an AWG or signal generator. The test stimulus will then be ready for playback.

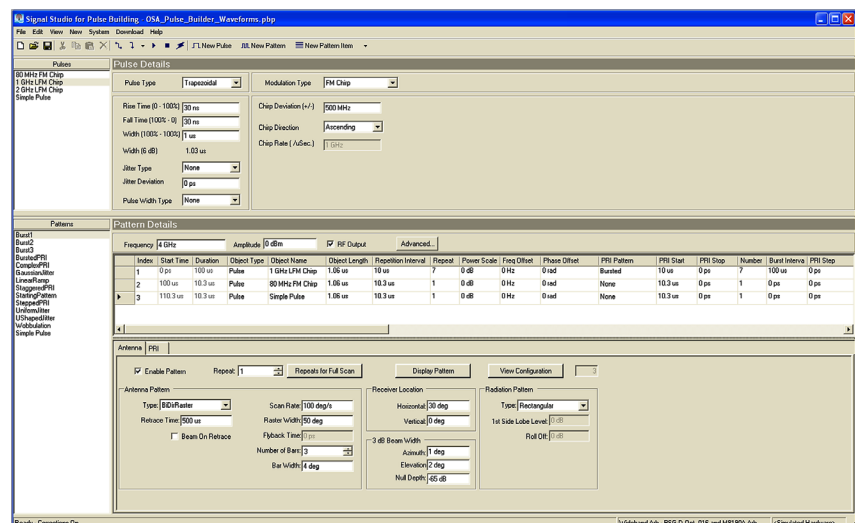

Figure 7. Keysight Signal Studio for pulse building

Generating Test Signals (continued)

Antenna pattern simulation

Signal Studio for Pulse Building features a variety of antenna pattern simulations that can be applied to waveforms. This feature is particularly useful for ELINT and EW applications in which the system to be tested needs to be immersed in a signal-rich environment that mimics real-world threats that may not be available. Many of these ELINT and EW systems use antenna pattern information to identify the particular threat being received.

Radar antenna patterns are somewhat unique because they usually involve a scanning or moving antenna beam dictated by the nature of the radar's mission (Figure 8). For example, a ship might have a rotating scan pattern to view objects on the ocean surface in all directions. A fighter jet likely employs a forward sector scan for its weather radar. A guided missile cruiser may use a phased-array antenna for its targeting radar, and the missile launched from the ship could well use a conical-scanning terminal radar.

Testing ELINT and EW systems that respond to these types of threats requires the ability to produce the appropriate pulse pattern that mimics the scanning radars.

Keysight's Signal Studio for Pulse Building supports a variety of antenna scan patterns, including circular patterns commonly found on ships, sector patterns found on aircraft, conical patterns often used on missiles, and raster scans typical of targeting phased arrays.

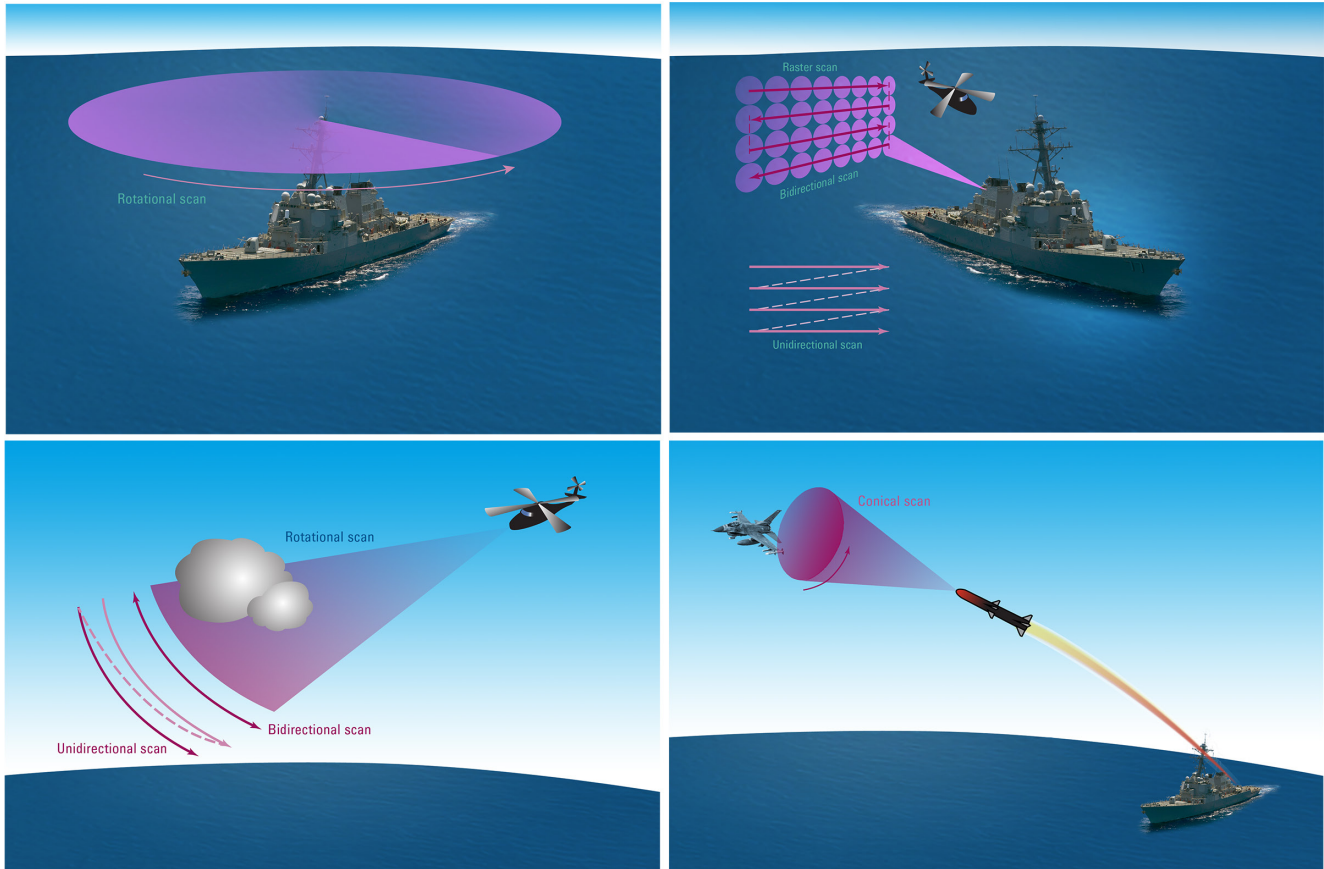

Figure 8. Antenna scanning patterns

Generating Test Signals (continued)

To accurately simulate a scanning antenna, it is also necessary to take into account the effects of the antenna side lobes. Because all directional radar beam antennas are of a finite size, they all exhibit some form of off-axis side lobe. Thus, as a radar scans, the main lobe of the antenna pattern is preceded by side lobes, then the main beam and finally more side lobes.

Combining the amplitude modulation caused by the scanning antenna and its side lobes with the pulse envelope modulation and its internal pulse compression modulation can be quite complex.

Keysight has made this process easy with Signal Studio for Pulse Building by allowing the user to also define antenna side lobes, pointing angles, target location, scan rates, beam widths, and roll off rates.

Signal Studio for Pulse Building also allows the user to define the antenna radiation patterns using popular spatial transform windows. Blackman, Hamming, Hanning, Rectangular, 3 Term, Cosine and even programmable windows are available for describing the spatial distribution of energy.

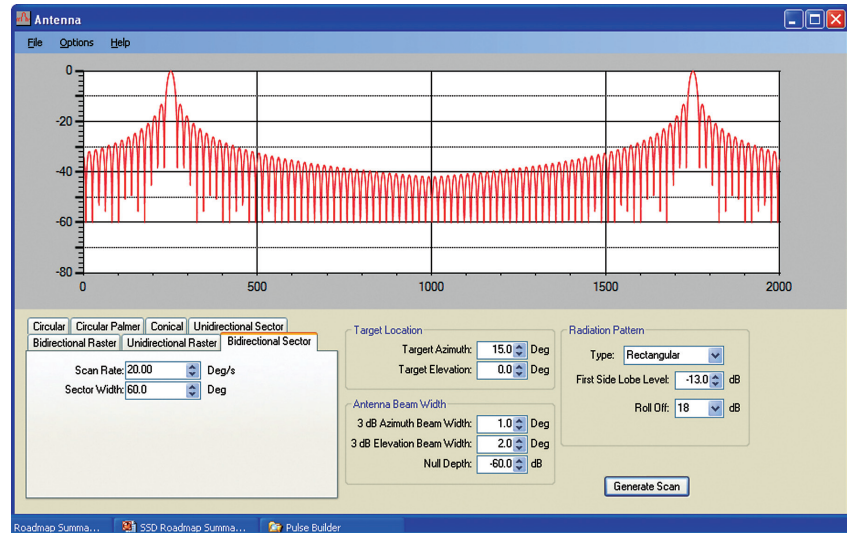

Figure 9. Antenna scanning simulation in signal studio for pulse building

Pulse pattern libraries

The need to generate feature-rich pulse patterns to simulate complex EW environments continues to grow with sophisticated equipment designed to respond to multiple threats automatically. Many organizations have cataloged emissions from a variety of radar sources to enable EW and targeting equipment to be pre-programmed to respond to each threat appropriately.

Signal Studio for Pulse Building is designed to interface with popular databases, including Microsoft Excel spreadsheets, to enable easy import of pulse characteristics. This handy import feature makes it easy to generate realistic EW mission scenarios to test radars and countermeasure equipment.

Generating Test Signals (continued)

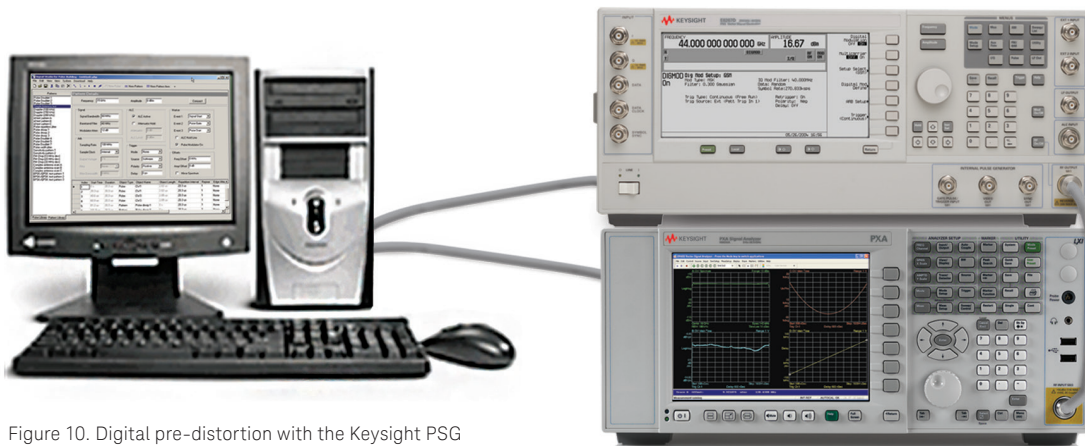

Figure 10. Digital pre-distortion with the Keysight PSG

Baseband pre-distortion

In terms of dynamic range, playing back recordings of mission scenarios is much like playing an analog music recording. If the recording's dynamic range is poor, the utility of the recording as a test signal may be of little value in determining the response of radar or EW equipment.

Keysight AWGs and signal sources have the best-available SFDR, a key selection criterion in many applications. To further expand the utility of these instruments, Keysight also offers the ability to enhance their performance with digital baseband radar pulse pre-distortion. Nonlinear effects in the DAC and subsequent components can distort the pulse pattern by causing intermodulation of the frequency components that make up the pulse. The intermodulation components effectively reduce the test signal's dynamic range.

Using digital pre-distortion of the Pulse Building synthesized waveforms allows these intermodulation products to be suppressed for unsurpassed dynamic range or amplified for margin testing.

With the addition of an external Keysight signal analyzer like the N9030A PXA, the synthesized test pulse pattern is analyzed and pre-distortion components are added in the source to compensate for test system nonlinearities. This sophisticated test system is easy to use, automatically determining and applying corrections to the measurement, which minimizes intermodulation distortion (IMD) products.

Now that we have seen how Keysight sources with Pulse Building can create detailed radar pulse patterns, how can this equipment provide the radar or EW engineer with a distinctive competitive edge when building mission-critical equipment? Let's examine some of the advantages with a synthetic test range example.

Synthetic Range Testing Example

As mentioned earlier, testing radars can be challenging. Historically, the radar engineer would rely on a field test range, usually a large area where several ships or airplanes could be steered about to evaluate if the radar would properly display their position and velocity. Though field testing often provides a realistic environment, it is generally an inferior option for the development engineer.

The challenges of working in the field are the primary reason that many radar test engineers choose to create a synthetic test range. The synthetic test range is a collection of test equipment capable of simulating the types of radar return echoes needed to test a radar's performance.

Though field testing can be helpful in simulating environmental conditions such as coastlines, mountains and clouds, it is often impractical to simulate realistic military mission scenarios. For example, it can be exorbitantly expensive to organize a full-scale attack that includes dozens of aircraft and ships approaching a coastal early warning radar station. In a similar vein, field testing may entail significant safety issues (e.g., potential collisions) that are not a factor in laboratory testing.

Finally, with many large-scale field tests it is often impossible to explore multiple scenarios. The cost of positioning radars and targets over hundreds of miles of range multiple times prevents fully exploring the capabilities of a radar, EW or ELINT receiver. Similarly, when testing spacecraft radar systems, field testing is cost prohibitive.

To overcome these issues, Keysight signal generators and arbitrary waveform generators along with Signal Studio for Pulse Building can create a synthetic test range in the laboratory environment, which is often preferred by the radar and EW engineer.

Simulation of scanning antennas

To illustrate the application of the signal generator to test an EW system, consider the problem of testing a shipboard early warning system. In this case, the EW system receives the radar pulses hitting the ship and analyzes them to determine the nature of their source and bearing angle to the source. Examining the pulse patterns as well as their varying amplitude caused by the antenna scanning pattern provides critical information to an EW countermeasure system.

The key to a successful test strategy is to provide a realistic set of radar pulse patterns and see if the EW countermeasure system takes the appropriate action such as jamming, range gate pull-off, chaff dispensing, and the like. In this example, we wish to see how the EW system responds to different radar signals such as those from a pleasure boat's radar or a surface-skimming missile.

To implement this test, we need only Keysight's Signal Studio for Pulse Building II and a Keysight PSG. Using the appropriate radar pulse definitions and antenna patterns, the different threats can be played out of the Keysight PSG to the EW system to see if it takes the appropriate action. In the case of the pleasure boat, nothing should happen, while in the case of the missile, the EW system should initiate the appropriate countermeasures.

Synthetic test ranges using Keysight test instruments not only provide realistic testing of shipboard equipment at a fraction of the cost of "live-fire" exercises, but they also provide excellent training simulators. For example, consider a ship that is in port for maintenance or restocking. Using a synthetic test range built around Keysight sources, the ships radar and EW receivers can be used to train ship personnel to deal with a variety of likely mission scenarios. This can be done without alerting unfriendly forces, which is a notable downside of at-sea exercises.

Synthetic Range Testing Example (continued)

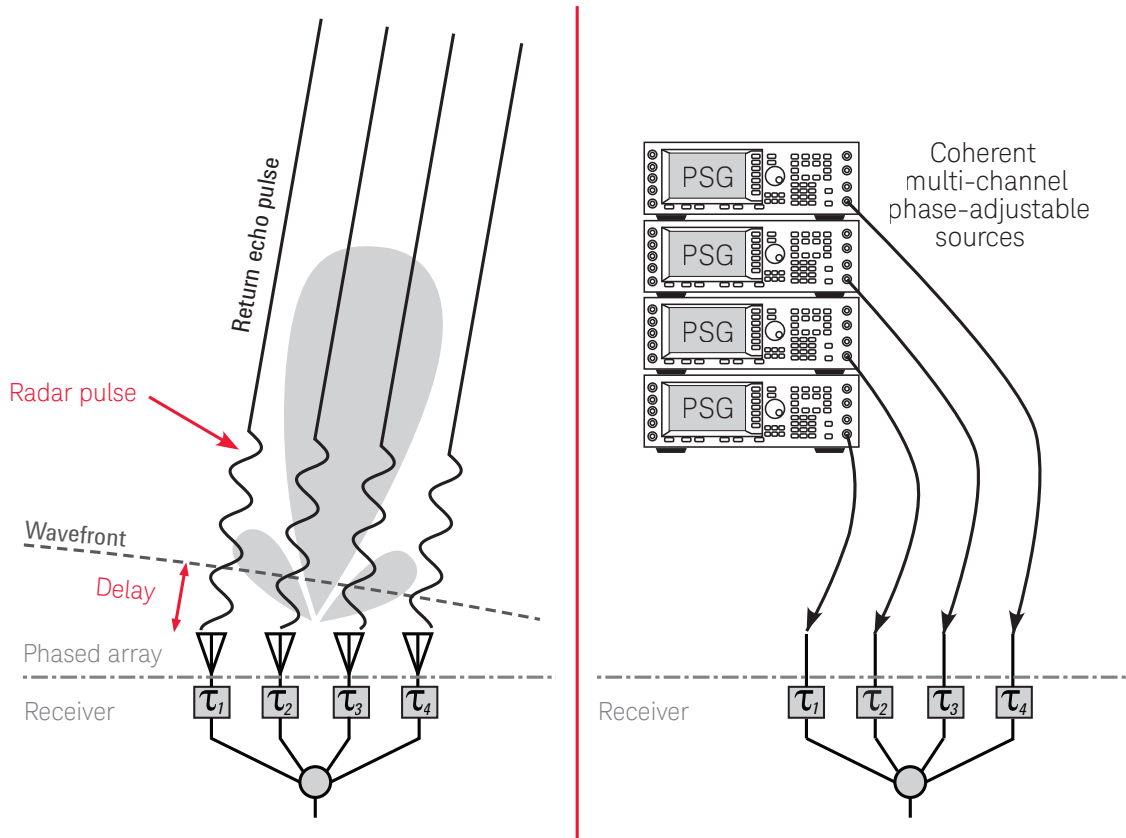

Figure 11. Creating a synthetic test range for phased-array radars

Coherent multi-channel receiver test

Keysight sources and Signal Studio for Pulse Building can be configured to simulate phased-array radars. These systems have many receiver inputs and rely on the phase of arrival of the incoming echoes. This can complicate testing because the receive signal must mimic a wavefront that contains multiple radar echoes arriving from distant points.

We address this need with signal sources such as the PSG (E8257D and E8267D) and the MXG (N5181B and N5182B), each of which can be coherently phase-locked and provides the ability to adjust the static phase relationship between sources. This enables Keysight sources to mimic pulse wavefront arrival for multi-channel phased-array systems. Possible approaches are described in the application note *Signal Source Solutions for Coherent and Phase-Stable Multi-Channel Systems* (publication 5990-5442EN).

Synthetic Range Testing Example (continued)

An alternative environment for system simulation and signal creation

Signal processing algorithms play an important role in advanced radar systems, especially high-performance multi-mode systems. Algorithm creation is a complex process that becomes more efficient when developers have access to a sufficient set of models for the various radar elements and functions: signal generation, multiple emitters, transmission, antennas, transmit/receive switching, clutter, noise, jamming, receiving, signal processing, and measurements.

The Keysight W1905 radar model library works within the Keysight SystemVue system-level design environment. SystemVue is an open modeling environment focused on physical-layer architectures at baseband and RF. It replaces general-purpose digital, analog and math environments, and it connects to a variety of FPGA and embedded-hardware design flows.

The W1905 library provides more than 50 highly parameterized simulation blocks (see Appendix, page 23) and more than 40 higher-level reference designs that can be used to create working radar-system scenarios that include radar processing blocks, environmental effects such as clutter, targets, and even hardware measurements. The library is applicable to pulsed-Doppler (PD) radar architectures as well as ultra-wideband (UWB) radars, digital arrays, beam-forming and frequency-modulated continuous-wave (FMCW) radars. With these tools, developers can model different types of radar sys-

tems, create radar signal-processing algorithms, evaluate system performance and provide proof-of-concept designs.

The W1905 library is also ideal for those who need to generate precise signals for verification of algorithms and hardware, or those who want to study the performance of radar systems under various conditions. For example, a key aspect of receiver testing is assessing performance in the presence of background clutter, multipath, ambiguous echoes, jamming interference and channel impairments. SystemVue provides modeling capabilities that support these needs (Figure 12).

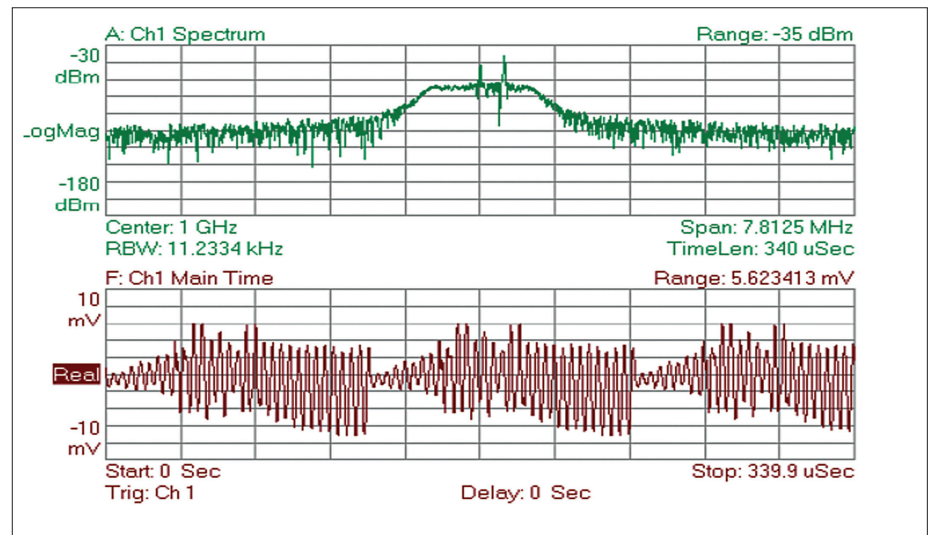

Figure 12. Return signals with clutter and jamming, as created with SystemVue and the W1905 library

Synthetic Range Testing Example (continued)

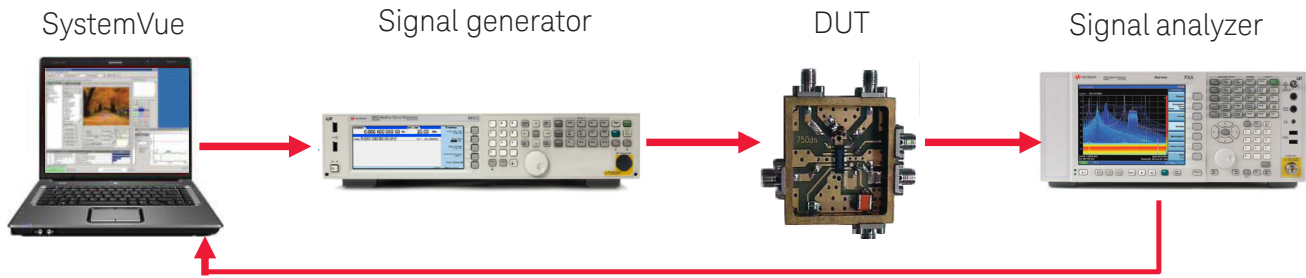

Figure 13. An example combination of software and instrumentation that can be used to create and generate radar test signals

To test devices still in development, SystemVue can be used to create highly realistic multi-emitter test signals. One of the key enabling technologies is a SystemVue feature called SignalCombiner. This feature enables the creation and combination of multi-emitter signals within the simulation environment. Through resampling, multiple emitters are combined into a single waveform that can be downloaded to a high-precision AWG such as the M8190A for playback. To learn more, please see the application note *Creating Multi-Emitter Signal Scenarios with COTS Software and Instrumentation* (Keysight publication 5991-1288EN).¹

To illustrate the creation of a radar signal, please see Figure 13. In this configuration, an interface model (“sink”) in SystemVue connects to a vector signal generator such as the PSG or MXG. Any radar waveforms generated in a SystemVue simulation can be automatically downloaded at runtime to the signal generator, which can produce the RF or IF test signals. In addition, waveforms captured with the signal analyzer can be transferred to SystemVue for processing and use in simulations.

1. The “Results, part 2” section on page 6 of note 5991-1288EN describes the creation of a multi-emitter environment that contains 16 radar signals, eight Barker-coded and eight LFM-chirped.

Synthetic Range Testing Example (continued)

When connected to appropriate stimulus/response instrumentation, this type of simulation platform can be used to manually imitate missing hardware blocks and thereby simulate a working radar system. This enables system-level validation earlier in the development process, even when working with partially implemented hardware. As real hardware becomes available, the simulation platform can be easily refocused on the task of providing targeted radar signals for the instrumentation to be used in testing.

For advanced analysis, SystemVue and the W1905 library can be combined with the 89600 VSA software. The 89600 VSA provides advanced general-purpose and standards-based tools for measuring signal characteristics in the time, frequency and modulation domains. The software can run on a PC or inside certain Keysight signal analyzers, logic analyzers and oscilloscopes.

In addition, the SystemVue/89600 combination provides an interface to a range of test equipment that can be used to verify the performance of implemented hardware. Examples include signal analyzers such as the N9030 PXA, logic analyzers such as the 16800 series and oscilloscopes such as the Keysight Infiniium 90000 X-Series.

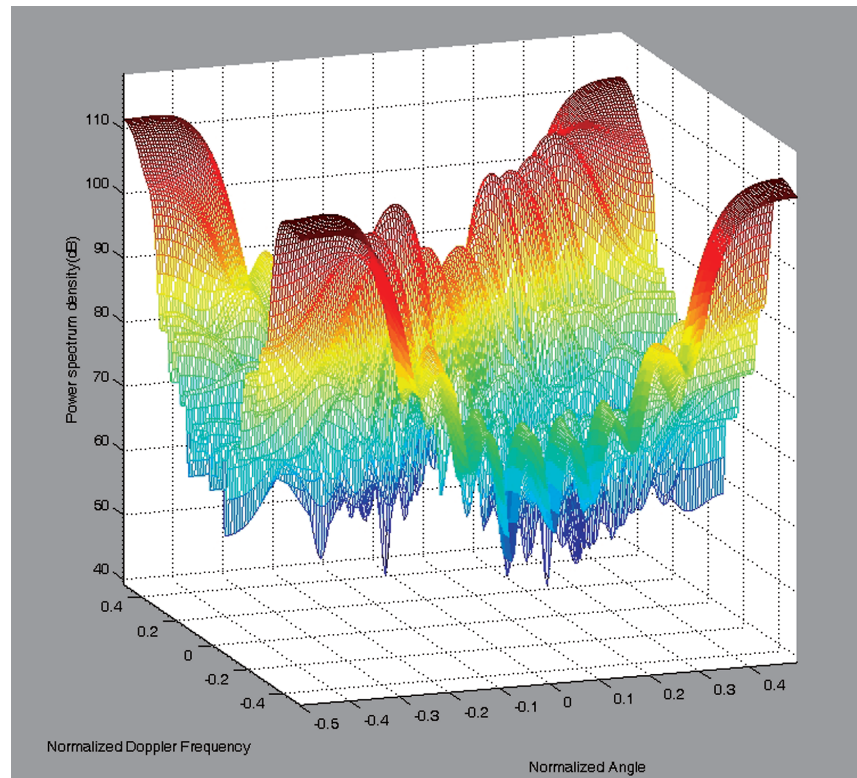

Figure 14. A MATLAB 3D visualization of pulsed-Doppler radar target returns with clutter models

SystemVue also integrates with MATLAB to enable analysis and visualization of complex radar signals (Figure 14). Capabilities include complete mathematical modeling within SystemVue using MATLAB math and computation functions.

Validation and Analysis of Radar Signals

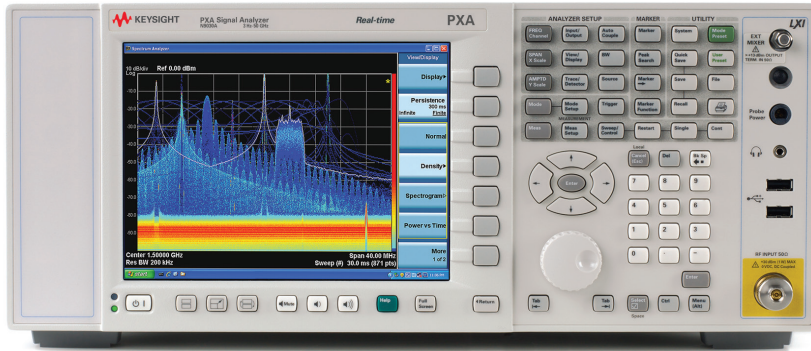

Figure 15. A real-time PXA helps you see, capture and understand highly elusive signals

Radar pulse analysis has become more challenging as developers have embraced the use of compression technology to reduce ambiguity and improve resolution and range. This approach requires the availability of capabilities such as wider bandwidths, modulation analysis and multi-domain displays in the analysis equipment.

Developers are also incorporating software-defined radar architectures in which stable, flexible digital implementations are rapidly replacing traditional analog IF and baseband signal processing. This too creates test challenges because the access to signals and the formats of those signals changes radically from baseband to RF.

To address these challenges, Keysight has created analysis instruments that provide the performance and flexibility needed to view virtually all radar signals across a wide range of formats.

Keysight analysis tools

To meet different needs across a range of price-and-performance points, we offer the X-Series family of benchtop signal analyzers and two lines of portable analyzers. The portable models include the handheld spectrum analyzers (HSA) and the FieldFox family. The HSA models enable basic spectrum analyzer measurements up to 20 GHz in the field and are well suited to installation and maintenance applications. A FieldFox handheld can be configured as a cable-and-antenna analyzer,

spectrum analyzer, vector network analyzer or combination analyzer with frequency coverage up to 26.5 GHz.

The X-Series includes four models, two of which are well-suited to radar applications: the high-performance PXA, which provides an analysis bandwidth of 160 MHz; and the versatile MXA, which provides a strong balance of speed, performance and cost effectiveness. Our latest enhancement is the availability of real-time spectrum analysis (RTSA) for the PXA. RTSA provides a real-time analysis bandwidth of up to 160 MHz and is an upgradeable option for new and existing PXAs. Adding RTSA creates a cost-effective solution that provides real-time analysis and traditional spectrum measurements in a single instrument (Figure 15). A real-time PXA provides the following key capabilities:

- 100 percent probability of intercept (POI) for signals with durations as short as 3.57 μ s
- Noise floor of -157 dBm at 10 GHz (no preamp)
- 75 dB spurious-free dynamic range
- Frequency-mask triggering (FMT) with a variety of conditional capabilities



Figure 16. Keysight's family of signal analysis tools

Validation and Analysis of Radar Signals (continued)

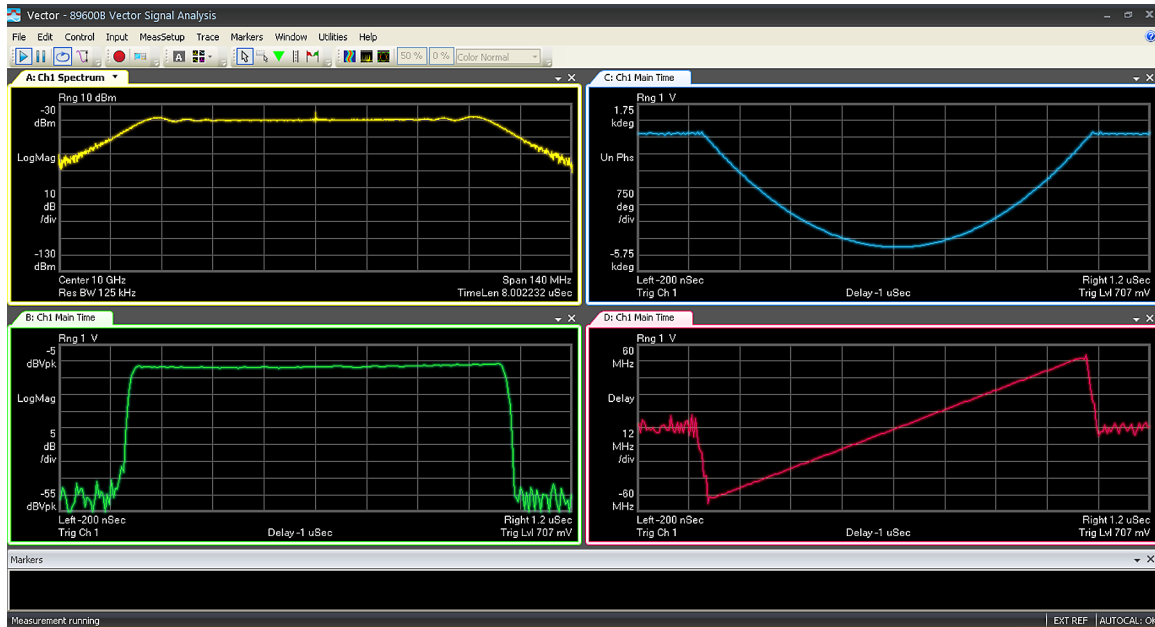

Figure 17. Viewing a chirp pulse with the 89600 VSA software

For thorough analysis of complex signals, the 89600 VSA software can be used with, or run inside, the X-Series signal analyzers. In addition to time- and frequency-domain capabilities, the 89600 VSA enables modulation-domain measurements of compressed radar pulses. In addition, the VSA software is compatible with the RTSA capabilities, including frequency-mask trigger, and supports capture and playback of culprit signals.

In ultra-wideband applications, Keysight also offers high-performance digitizers and oscilloscopes. For example, the M9703A is an eight-channel, 12-bit AXIe digitizer that can capture signals from DC to 2 GHz. It provides up to 3.2 GSa/s with four channels and up to 1.6 GSa/s with eight channels. The M9703A supports long acquisitions with up to 4 GB of internal memory. The Infiniium 90000 X-Series and Q-Series oscilloscopes are another alternative: these offer bandwidth of up to 63 GHz, sampling up to 160 GSa/s and up to 2 Gpoints of memory. For advanced analysis,

the M9703A and the 90000 X-Series and Q-Series scopes are compatible with the 89600 VSA software.

To illustrate the capabilities of our analysis tools, it will be worthwhile to look at some example measurements.

This overview begins with essential measurements such as pulse analysis and continues with difficult signal-quality measurements and, finally, software-defined radar measurement capabilities.

Deciding when to use an oscilloscope or a signal analyzer

Your analysis requirements will help you determine when to use an oscilloscope or a signal analyzer. The key factors are analysis bandwidth and the required number of measurement channels. Additional factors include dynamic range, spurious performance and error vector magnitude (EVM) measurements.

Currently, the highest-performance signal analyzers have a maximum analysis bandwidth of 160 MHz. Thus, if the required analysis bandwidth is 160 MHz or less, then either a signal analyzer or scope can be used. If a wider bandwidth is required, then a high-performance oscilloscope is the best choice.

If multiple phase-coherent channels are required, then an oscilloscope is often the best choice. When one channel is enough, a standalone signal analyzer such as the PXA usually has an advantage in the other factors: dynamic range, spurious performance, and EVM performance and measurement speed.

Validation and Analysis of Radar Signals (continued)

Pulse analysis

The testing of radar, EW and ELINT systems requires a variety of routine measurements. As mentioned earlier, measurements of pulse width and PRI (or PRF) provide important information about a radar system's resolution and range, and can reveal potentially important intelligence information. Automated measurements of pulse parameters can accelerate radar diagnostics and provide a wealth of EW information.

Two software applications can be used to automate these measurements: The PXA and MXA signal analyzers can be configured with the N9051A pulse measurement application, and oscilloscopes such as the Infiniium 90000 can be equipped with the W2650A oscilloscope signal analysis (OSA) software. An X-Series analyzer with N9051A is the better choice when high dynamic range is needed, pulse-modulation bandwidths are less than 160 MHz, and spectrum and spurious measurements are needed. Multiple views enable concurrent analysis of power vs. time, frequency vs. time, phase vs. time or power vs. frequency. Base capabilities include PRI, PRF and pulse parameters such as width, duty cycle, rise time, fall time, droop, overshoot and ripple. An extended analysis option enables statistical analysis of up to 200,000 pulses via trend analysis or histogram plots.

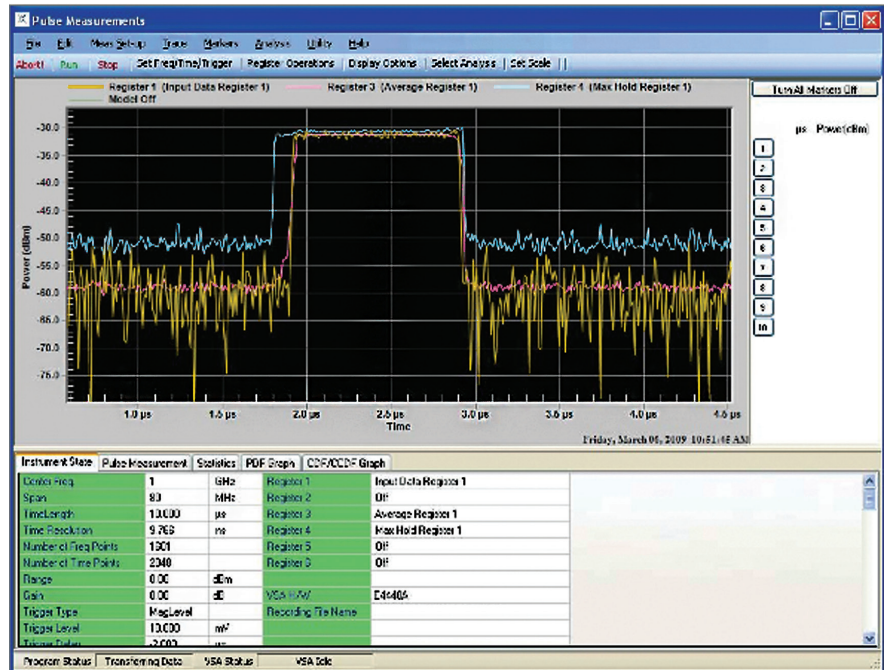

Figure 18. Pulse analysis with the N9051A measurement software

An oscilloscope with W2650A can handle bandwidths greater than 160 MHz and is the better choice when dynamic range is less important than bandwidth. The scope also provides segmented memory, which simplifies the analysis of a long series of pulses. For pulse analysis, key capabilities include PRF, PRI, pulse frequency (mean, min, max, deviation, excursion), pulse modulation (chirp, Barker), and more. W2650A also supports continuous-wave and modulation measurements including frequency hopping signal pattern and duration.

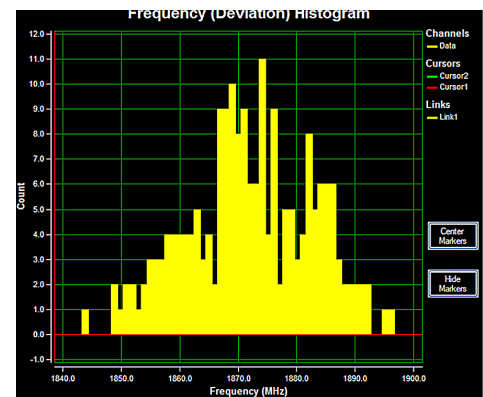

Figure 19. Advanced pulse analysis with the W2650A OSA software includes statistical capabilities with histogram displays

Validation and Analysis of Radar Signals (continued)

Multi-format modulation analysis with the 89600 VSA

Software-defined radar architectures present unique challenges in testing because the signal format changes from the familiar coaxial analog microwave transmission line to the digital bus that often resides deep inside an FPGA. This type of mixed analog-and-digital implementation poses the problem of being able to perform advanced analysis of modulated pulses on vastly different signal formats but with consistent results.

The 89600 VSA software interfaces with a variety of Keysight instruments—signal analyzers, oscilloscopes, logic analyzers, and more—that can serve as analog or digital front-ends for signal acquisition. In addition, the 89600 VSA is compatible with the Keysight Advanced Design System (ADS) circuit-modeling software. Not only does this simplify the process of learning how to make measurements with an instrument, it also ensures consistency between

measurements because the same VSA algorithms are used to process analog and digital signals. Using a 16800 logic analyzer as the front end for the 89600 VSA enables use of the Keysight ATC2 FPGA design core. The ATC2 design core allows for seamless access to internal data buses of supported FPGAs from Xilinx and Altera, enabling sophisticated signal analysis directly on real-time FPGA design implementations.

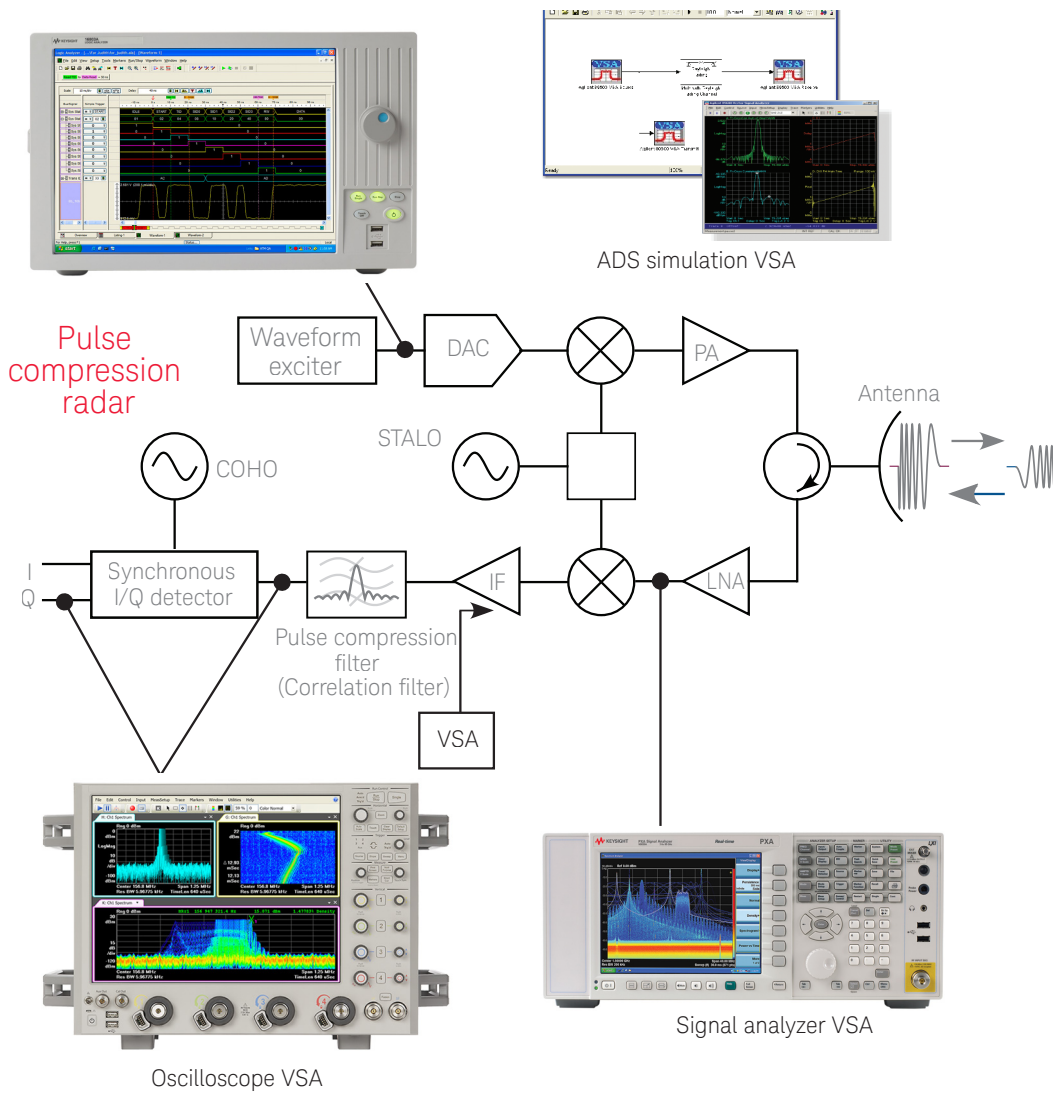

Figure 20. Multi-format analysis with the 89600 VSA software

Appendix: Block List for the W1905 Radar Model Library

Name	Description
RADAR_AmbgtResolution	RADAR range and velocity ambiguity resolution
RADAR_ANTENNA	Radar Antenna
RADAR_ANTENNA_PATTERN	Radar Antenna_Pattern
RADAR_ArrayFilter	Array Optimum Filter
RADAR_BarkerCode	Barker Coded Waveform Generator
RADAR_C FAR	Constant False Alarm Rate
RADAR_CICDecimate	RADAR CIC Decimation
RADAR_CICInterp	RADAR CIC Interpolation
RADAR_Clutter	RADAR clutter simulation
RADAR_Clutter_2D	Radar clutter simulation
RADAR_Clutter_H	Radar clutter simulation
RADAR_ClutterGen	Radar clutter simulation with statistics method in space domain
RADAR_CoIntgr	Signal Coherent Integration
RADAR_CW	Radar CW waveform generation
RADAR_DBF_Clutter_2D	Digital Array Radar clutter ring simulation
RADAR_DBF_Target_2D	Radar target 2D simulation for digital beamforming, including RCS, Doppler effect, Delay and Attenuation
RADAR_DDC	RADAR Digital Down Converter
RADAR_DDS	Direct Digital Synthesis
RADAR_Detector	RADAR Detector
RADAR_DUC	RADAR Digital Up Converter
RADAR_Equation	Radar Range Equation
RADAR_Equation_Augmentation	Radar Equation for Active Augmentation
RADAR_Equation_Bistatic	Radar Range Equation for Bistatic Radar
RADAR_Equation_Clutter	Radar Equation for area/volume target/clutter
RADAR_Equation_Jamming	Radar Equation for Self-Protection Jamming and Standoff Jamming
RADAR_FrankCode	Frank Coded Waveform Generator
RADAR_KALMAN	Radar Kalman Filter
RADAR_LFM	Linear Frequency Modulation Waveform Generator
RADAR_LFMRef	Linear Frequency Modulation Waveform Reference Function
RADAR_MatchedSrc	generate the matched source signal for pulse compression
RADAR_MTD	Moving Target Detection
RADAR_MTI	Moving Target Indication
RADAR_MultiCH_Rx	Quadrature amplitude demodulator with internal oscillator
RADAR_MultiCH_Tx	RADAR ideal multichannel transmitter
RADAR_NLFM	Non-Linear Frequency Modulation Waveform Generator
RADAR_NonCoIntgr	Signal Coherent Integration
RADAR_PC	Pulse Compression
RADAR_PD	Pulse Doppler
RADAR_Pd_Measurement	Detection Probability Estimation
RADAR_Pf_Measurement	False Alarm Rate Estimation
RADAR_PhaseShift	RF phase shifter continuously interpolated between time steps
RADAR_PULSE	Simple Pulse Waveform Generator
RADAR_Pulse_Compression	Pulse Compression
RADAR_QuadSample	RADAR quadrature sampling
RADAR_RCS	Radar target RCS
RADAR_Rx	RADAR Receiver Front End
RADAR_Rx_4x4	RADAR Receiver Front End for 4x4 MIMO
RADAR_Rx_DBS_2D	2D Rectangular Array Digital Beam Synthesis
RADAR_SAR_Echo	SAR Echo Generation
RADAR_SEA_CLUTTER	Radar Sea clutter simulation
RADAR_STAP	2D Rectangular Array Space-Time Adaptive Processing
RADAR_StepFreq	Stepped Frequency Generator
RADAR_SummerBusRF	RF signal summer
RADAR_Switch	Tx/Rx switch
RADAR_Target	Radar target simulation, including RCS, Doppler effect, Delay and Attenuation
RADAR_Target2	Moving Target
RADAR_Target_Vector	Radar target simulation, including RCS, Doppler effect, Delay and Attenuation
RADAR_TargetDetet	Target Detecting Algorithm which is used to detect target from noise
RADAR_TargetEcho	Moving Target
RADAR_TargetTrack	Target Tracking Algorithm which is used to track single target
RADAR_TargetTrajectory	Target Trajectory
RADAR_Tx	RADAR Transmitter Front End
RADAR_Tx_4x4	RADAR Transmitter Front End for 4x4 MIMO
RADAR_Tx_DBS_2D	2D Rectangular Array Tx Digital Beam Synthesis
RADAR_Tx_DBS_Measurement	RF transmitter antenna pattern measurement
RADAR_Tx_Synthesis	RF transmitter antenna array synthesis
RADAR_WaveGate	Wave Gate to capture and process the echo signal
RADAR_ZCCode	Zadoff-Chu Coded Waveform Generator

Conclusion

The latest generations of radar and EW systems operate in a variety of frequency bands and use wideband or UWB signals that carry highly complex modulation schemes. These systems also use advanced DSP techniques to mask or disguise their operation and thereby avoid jamming.

The ongoing evolution of these systems will continue to challenge the performance and capabilities of the solutions needed to generate test signals, create synthetic test ranges with multiple emitters, and validate and analyze radar signals and systems. As described in this note, the interconnection and interaction of test-and-measurement instrumentation and software provides a flexible foundation for a variety of useful solutions:

- For signal creation, tools such as the high-resolution, wide-bandwidth M8190A AWG and the powerful Signal Studio for Pulse Building software enable creation of highly realistic signal scenarios.
- For signal analysis, the PXA provides excellent analysis bandwidth and dynamic range, and offers optional real-time spectrum analyzer capabilities.
- For advanced signal analysis, the 89600 VSA software adds time-, frequency- and modulation-domain capabilities to X-Series signal analyzers for microwave frequencies, Infiniium scopes for UWB analysis, and 16800 logic analyzers for digital signals.

All these solutions are ready for the challenges you face today, and are future-ready for the evolving requirements you'll encounter over the horizon.

Evolving Since 1939

Our unique combination of hardware, software, services, and people can help you reach your next breakthrough. We are unlocking the future of technology.

From Hewlett-Packard to Agilent to Keysight.



For more information on Keysight Technologies' products, applications or services, please contact your local Keysight office. The complete list is available at: www.keysight.com/find/contactus

Americas

Canada	(877) 894 4414
Brazil	55 11 3351 7010
Mexico	001 800 254 2440
United States	(800) 829 4444

Asia Pacific

Australia	1 800 629 485
China	800 810 0189
Hong Kong	800 938 693
India	1 800 11 2626
Japan	0120 (421) 345
Korea	080 769 0800
Malaysia	1 800 888 848
Singapore	1 800 375 8100
Taiwan	0800 047 866
Other AP Countries	(65) 6375 8100

Europe & Middle East

Austria	0800 001122
Belgium	0800 58580
Finland	0800 523252
France	0805 980333
Germany	0800 6270999
Ireland	1800 832700
Israel	1 809 343051
Italy	800 599100
Luxembourg	+32 800 58580
Netherlands	0800 0233200
Russia	8800 5009286
Spain	800 000154
Sweden	0200 882255
Switzerland	0800 805353
	Opt. 1 (DE)
	Opt. 2 (FR)
	Opt. 3 (IT)
United Kingdom	0800 0260637

For other unlisted countries:
www.keysight.com/find/contactus
 (BP-9-7-17)

DEKRA Certified
ISO 9001 Quality Management System

www.keysight.com/go/quality
 Keysight Technologies, Inc.
 DEKRA Certified ISO 9001:2015
 Quality Management System

myKeysight

myKeysight

www.keysight.com/find/mykeysight

A personalized view into the information most relevant to you.

www.keysight.com/find/emt_product_registration

Register your products to get up-to-date product information and find warranty information.

KEYSIGHT SERVICES

Accelerate Technology Adoption.
Lower costs.

Keysight Services

www.keysight.com/find/service

Keysight Services can help from acquisition to renewal across your instrument's lifecycle. Our comprehensive service offerings—one-stop calibration, repair, asset management, technology refresh, consulting, training and more—helps you improve product quality and lower costs.



Keysight Assurance Plans

www.keysight.com/find/AssurancePlans

Up to ten years of protection and no budgetary surprises to ensure your instruments are operating to specification, so you can rely on accurate measurements.

Keysight Channel Partners

www.keysight.com/find/channelpartners

Get the best of both worlds: Keysight's measurement expertise and product breadth, combined with channel partner convenience.

www.keysight.com/find/ad



This information is subject to change without notice.
 © Keysight Technologies, 2017
 Published in USA, December 1, 2017
 5990-7036EN
www.keysight.com