

UNCLASSIFIED
GARY ROSA LIBRARY

APPLICATION NOTE 3

Measurement of the Carrier Frequency of RF Pulses

The problem of accurate determination of carrier frequency during short rf pulses is discussed. Several methods are described for making such measurements from UHF to X-band, and typical results are given. By one method, a carrier frequency in the vicinity of 1000 MC which is modulated by 2.5 microsecond pulses at a 30 cycle repetition rate is measured with an accuracy of ± 10 KC.

Introduction

Within the last few years, frequency measuring techniques have been greatly improved by the advent of high-speed electronic counters. These instruments have been applied successfully to the direct measurement of CW signals in the range from DC to a few megacycles. Heterodyne techniques have been used to extend this range into the hundreds of megacycles with accuracies limited mainly by that of present frequency standards.*

On examination of the possible requirements for further extension of this range, it becomes apparent that many of the applications of the high end of the spectrum involve microsecond pulses. Although precision wavemeters have been used in pulsed rf applications, there are many cases where accuracies of a higher order of magnitude are required.

The combination of a counter and a transfer oscillator is extremely useful in such applications.

The transfer oscillator is a stable, tunable oscillator whose fundamental frequency lies within the range of CW measuring equipment such as a frequency counter. While its fundamental is monitored by the counter, the oscillator is tuned until one of its harmonics can be compared to the unknown frequency, or until the transfer oscillator fundamental is near a harmonic of the unknown. The accuracy of such a measurement depends to a large extent on the ability of the operator to reduce the difference between the unknown and a harmonic frequency to zero. This in turn depends upon the stability and ease of adjustment of the transfer oscillator as well as the ability of the comparison device to display the magnitude (and possibly the sign) of the difference frequency.

Presented at fourth conference on high frequency measurement, Washington, D. C., January 19, 1955.

There have been many applications where earphones or a tuning eye are adequate means for obtaining "zero beat". However, when the measured signal is pulse modulated or frequency modulated, the difference signal is also pulse modulated or frequency modulated, and it would appear that a better means of observing the difference frequency is on the face of a cathode-ray tube.

The remainder of this paper will deal with several methods of obtaining useful presentations of the difference signal, with particular attention to pulsed rf signals.

The presentations to be described were obtained with a transfer oscillator whose fundamental covers the range from 100 to 210 MC. The high harmonic content of its output makes it useful for measurements up to 10,000 MC. Its stability and ease of adjustment allow comparisons to well within one part-per-million.

It will be shown that even in the case of short rf pulses, this stability is justified when certain comparison methods are used. One method will be shown which produced accuracies of a few parts in ten-million in the measurement of 10 microsecond pulses of a 1000 MC carrier.

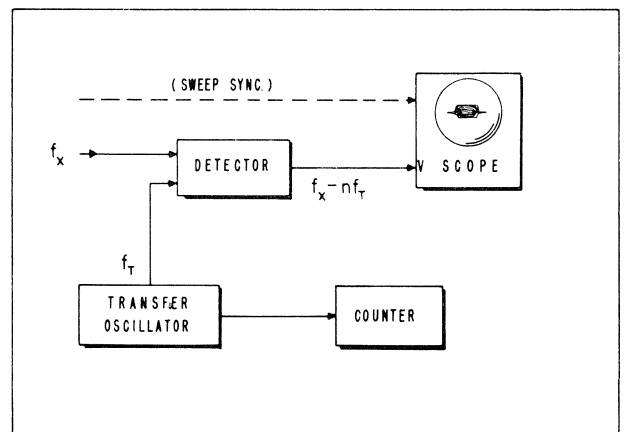

Figure 1. Block Diagram for Pulse Presentation

*All ranges have been extended by HP since 1955 to 18 GHz for heterodyne techniques, to 40 GHz for transfer oscillators, and to 12.4 GHz for automatic frequency dividers.

Pulse Presentation

Figure 1 illustrates the most obvious method of observing a difference signal. The detector output is connected directly to the vertical input terminal of a C-R oscilloscope. When f_x consists of pulses of rf, the detector output will consist of the difference frequency, pulse modulated. As the transfer oscillator is adjusted to bring this difference frequency within the bandwidth of the oscilloscope amplifier, one might expect the appearance of a trace similar to Figure 2A, assuming a properly established horizontal sweep. However, it is very unlikely that the cycles of the difference signal will be synchronized with the pulse envelope, and the multiple trace of Figure 2B is a more accurate representation. Notice that approximately five cycles of the difference frequency are shown within the pulse envelope. For a 1 microsecond pulse, this would correspond to a difference frequency of 5 megacycles. As this error is further reduced by careful tuning of the transfer oscillator, traces similar to Figures 3A, B and C will appear. In Figure 3A, one cycle of the difference frequency appears during the pulse while Figures 3B and 3C depict difference frequencies of one-tenth of a cycle per pulse width and one-hundredth of a cycle per pulse width respectively.

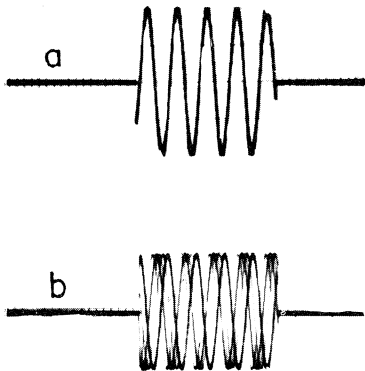

Fig. 2. Pulse Presentation showing (a) single trace, and (b) multiple trace

Assuming a 1 microsecond pulse width, these three figures will then indicate to the operator that some harmonic of the transfer oscillator is within 1 MC, 100 KC or 10 KC of the unknown carrier frequency. The fundamental frequency of the transfer oscillator is then read directly from the panel of the counter. Usually the approximate frequency of the carrier is known so that it is a simple matter to determine which harmonic of the transfer oscillator has been used in the comparison. The counter reading, when multiplied by the order number of this harmonic, is the final accurate representation of the carrier frequency.

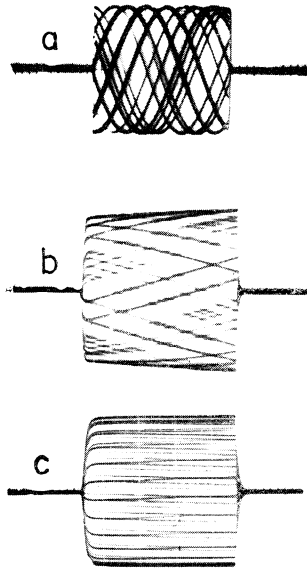

Fig. 3. Pulse Presentation for difference frequencies of (a) one, (b) one-tenth, and (c) one one-hundredth cycle-per-pulse-width

If the harmonic order is not known, it can be quickly determined by tuning the transfer oscillator until an adjacent harmonic falls on the carrier frequency. If the original frequency of the transfer oscillator is f_1 and the new setting is at a frequency of f_2 , the carrier frequency is given by Nf_1 where N is a simple integer given by

$$N = \frac{f_2}{(f_1 - f_2)}$$

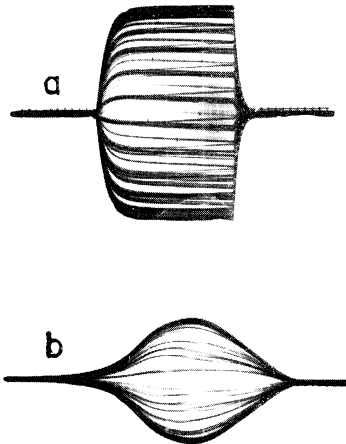

Fig. 4. Pulse Presentation of (a) limited bandwidth, and (b) gaussian pulse

Figure 4A indicates a small amount of deterioration in the presentation due to bandwidth limitation, and Figure 4B illustrates the case of Gaussian Pulse Modulation. In all cases "zero beat" is approached by attempting to produce some traces having no vertical deflection. If there is FM present during the

pulse, this will not be possible, but horizontal underdeflected lines may be produced during various portions of the pulse, and the amount of FM can be measured by this means. Video bandwidth limitation has been found useful in cases of excessive noise or "ringing" on the modulating pulse.

Although the above technique was used very successfully at pulse repetition rates of from 50 cps to 5 KC, it was noticed that excessive crowding of traces at high repetition rates resulted in a slight loss in accuracy. A presentation that does not require the resolution of individual traces is illustrated in Figure 5.

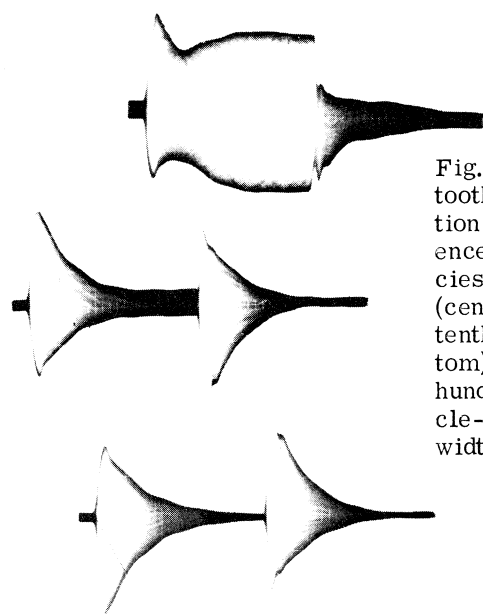

Fig. 5. Sawtooth Presentation for difference frequencies of (top) one, (center) one-tenth, and (bottom) one one-hundredth cycle-per-pulse-width

Sawtooth Presentation

This presentation was obtained by inserting a simple RC differentiating circuit ahead of the vertical input terminal on the oscilloscope in Figure 1. The time constant of this RC circuit should be on the order of one-tenth of the pulse width. Zero beat is then indicated by the first exponential envelope decaying to a sharp point. With too short a time constant, convergence will occur in spite of a relatively high difference frequency, while with too long a time constant, convergence will not occur even at zero beat. This is indicated by Figures 5A, 5B, and 5C, which illustrate respective difference frequencies of one, one-tenth, and one-hundredth cycle-per-pulsewidth.

Direction of Error

Although both of the above presentations tell the operator roughly how far he is from zero beat, they completely lack information as to whether he is

above or below that point. Such information would be an obvious aid to the tuning procedure. The detection method indicated in Figure 6 preserves this information by supplying two difference frequency outputs whose relative rf phase indicates the sign of the frequency difference. Methods of presenting the information contained in these two outputs are described below.

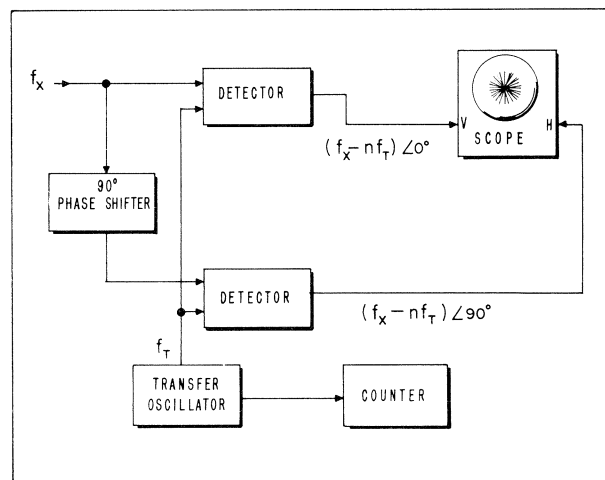

Fig. 6. Block Diagram for Spoke Presentation

Spoke Presentation

In Figure 6, two detectors are arranged so as to receive signals from the transfer oscillator in the same phase, while signals from the input terminal arrive at one detector after a phase shift of 90° . Thus, two difference frequency signals are produced which differ in rf phase by 90° .*

Assume for the moment that a CW signal is being measured and that the resulting CW difference frequency signals are connected to the horizontal and vertical inputs of the oscilloscope. The 90° phase difference between these signals will produce a circular trace, with the spot rotating at the difference frequency. The direction of rotation will be determined by the sign of the difference frequency. Thus, as the transfer oscillator is tuned through zero beat the rotation will slow down, stop, and then proceed in the opposite direction.

* The results shown were obtained with the two detectors spaced one-eighth wavelength apart (at f_x) on a section of line fed by f_x at one end and f_t at the other. The resulting 45° phase shift in each signal produces the desired 90° difference in the phases of the outputs.

The circle will have a radius which is determined by the amplitude of the CW input signal and will degenerate to a point when that signal disappears.

Thus, a burst of rf due to pulse modulation will cause the trace to jump to the circumference of the circle, rotate for a number of revolutions determined by the difference frequency, and then return to a point in the center of the circle. If the difference frequency is reduced so that only a fraction of a cycle occurs during each pulse, the trace will be on the circumference for only that fraction of a revolution. Radial spokes will appear, whose intensity depends on the rate of rise or fall. If the pulse envelope (including any effects of system bandwidth limitation) is such that the rise and fall rates near the peak of the pulse are markedly different, the pattern is dominated by the more intense radial traces. The amount and direction of any curvature of these traces indicates the amount and sign of a frequency difference. Simple integrating or differentiating networks at both inputs to the oscilloscope can be used to accentuate this effect. At zero beat, the traces will appear as straight radial spokes. This is shown in Figures 7A and 7B. Figures 8A and 8B illustrate errors of one-tenth cycle-per-pulsewidth and one one-hundredth cycle-per-pulsewidth, respectively.

The direction of error feature of this presentation has proved to be an aid to both speed and accuracy of measurement. A series of tests using the spoke presentation at various pulse repetition rates has indicated that there again is some loss in accuracy due to a crowding of traces at high rates.

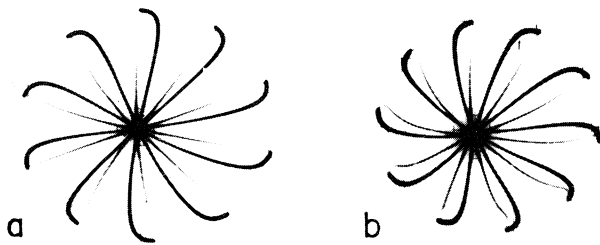

Fig. 7. Spoke Presentation for Transfer Oscillator harmonic (a) above, and (b) below carrier frequency of pulse

Pointer Presentation

As far as pulse work is concerned, this novel presentation has the advantage of being an envelope display which does not require the resolution of individual traces. In Figure 9 is shown the rather simple modification of the circuit of Figure 6 which produces

this particular presentation. A simple RC low pass filter is inserted in the vertical deflection circuit and a high pass filter is inserted in the horizontal deflection circuit. These circuits have a crossover frequency f_c which is given by $f_c = 1/2\pi RC$. Their transfer functions are such as to produce an additional 90° of phase difference between the vertical and horizontal inputs at all frequencies.

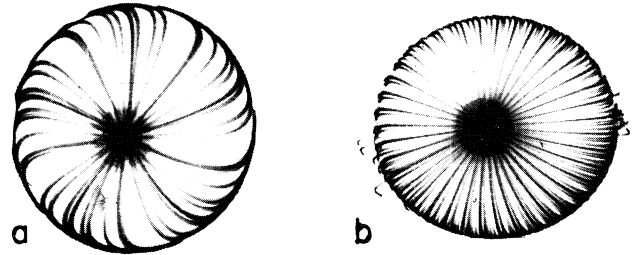

Fig. 8. Spoke Presentation for difference frequencies of (a) one-tenth, and (b) one one-hundredth cycle-per-pulsewidth

In analyzing this circuit, note that in Figure 6 a CW difference signal produced a circular trace whose direction and rate of rotation was determined by the difference frequency. Let us now examine the effect of the crossover networks on this pattern. The additional 90° phase difference transforms the circle back into a straight line. The slope of this line is determined by the amplitude vs. frequency characteristic of the networks. Low difference frequencies are passed by the vertical circuit and attenuated by the horizontal circuit, producing an almost vertical line. High difference frequencies are passed by the horizontal circuit and attenuated by the vertical circuit, producing a line of low slope. As the transfer oscillator is tuned through zero beat, the phase of the horizontal signal reverses with respect to the phase of the vertical signal. Thus, for CW, a straight line trace is produced whose angular deflection from the vertical axis increases with difference frequency, the sign of this deflection indicating whether the transfer oscillator frequency is high or low. The deflection is 45° at a difference frequency equal to the crossover frequency. The similarity of this presentation to a zero center meter presentation is obvious, and indeed a true meter presentation can be obtained by feeding the two oscilloscope inputs into a pure product modulator instead.

Figures 10A, 10B, and 10C illustrate the presentation for a CW signal which is respectively below, "on" and above a harmonic of the transfer oscillator. The usual low frequency cutoff of the vertical amplifier produces a very sharp null indication at zero beat.

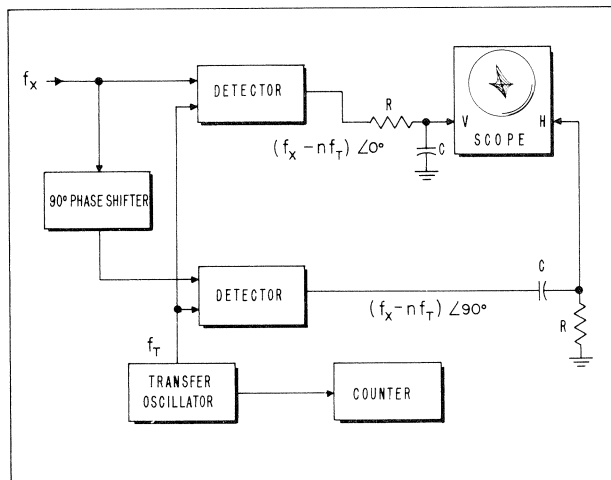

Fig. 9. Block Diagram for Pointer Presentation

Figure 11A is the pattern obtained with a varying frequency below that of the transfer oscillator harmonic. Figure 11B indicates a widely varying frequency which sweeps through zero beat.

Figure 12 was obtained with a signal containing both amplitude and frequency modulation. In Figure 12A, the transfer oscillator was adjusted to obtain zero beat at the trough of the amplitude modulation. In Figure 12C the transfer oscillator was adjusted to measure the frequency at the peak of amplitude modulation and Figure 12B indicates an intermediate setting.

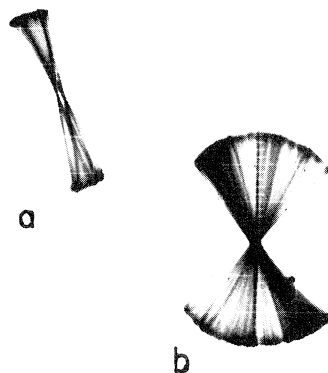

Fig. 11. Pointer Presentation for (a) varying frequency below zero beat, and (b) frequency which swings through zero beat

This presentation has obvious merit as a non-sweeping spectrum analysis. However, at pulse rates which permit resolution of individual traces, slightly better accuracy has been obtained using the "spoke" presentation.

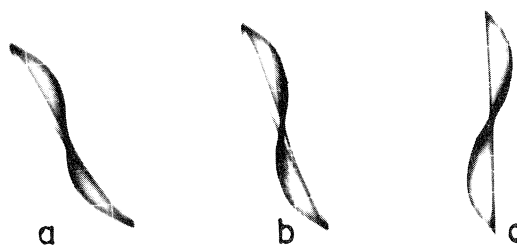

Fig. 12. Pointer Presentation for simultaneous FM and AM with zero beat at (a) trough, (b) average, and (c) peak of modulation

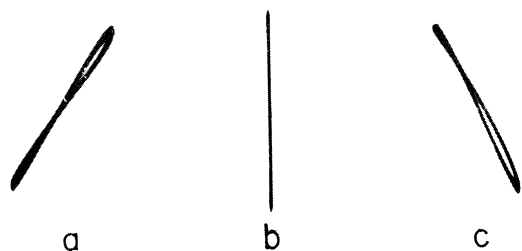

Fig. 10. Pointer Presentation for CW signal (a) below, (b) "on", and (c) above harmonic of Transfer Oscillator

The wide spectrum due to pulse modulation produces patterns such as shown in Figure 13. Again, Figures A, B, and C indicate carrier frequencies below, "on", and above the transfer oscillator harmonic. This pattern was obtained with a 10 microsecond pulse and a crossover frequency of 100 KC.

Accuracy

Figure 14 shows the distribution of 120 frequency readings using the "spoke" presentation at various repetition rates. The distribution curve for readings at all rates indicates an rms error of only 2 or 3 parts in ten-million. Thirty readings were taken at each rate. The individual distribution curves indicate an increase in accuracy with increasing rate up to about 1000 pps. The accuracy has started to deteriorate at 5000 pps, apparently due to the crowding of traces. At higher pulse rates, an envelope display as in Figure 5 of 13 is indicated.

Due to the increase in frequency spectrum with decreasing width in a modulating pulse, a figure of merit for such pulsed rf measurement is the fractional part of a difference frequency cycle which occurs during the pulse. In general, all of the systems described here have produced measurement accuracies on the order of one one-hundredth of a cycle-per-pulsewidth. The accuracy indicated by Figure

14, where all of the readings are within plus-or-minus one two-hundredth of a cycle-per-pulsewidth, is two or three times better than results obtained with other presentations.

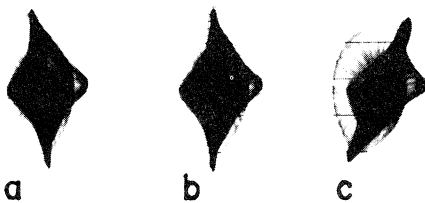

Fig. 13. Pointer Presentation for pulse modulation of carrier which is (a) below, (b) "on", and (c) above Transfer Oscillator harmonic

These measurements were made under more or less ideal laboratory conditions with a very stable source of pulsed rf. Measurements made on a DME transmitter in the field produced errors on the order of 10 KC for a 2.5 microsecond pulse. This corresponds to a difference frequency of one-fortieth of a cycle-per-pulsewidth.

"3-D" Presentations

Certain similarities in the behavior of the various presentations described above led to speculation that all of the presentations could be regarded as different views of a three-dimensional form which represents the difference signal as variously modified by system bandwidth limitations. This form lies along the time axis and its dimensions in any plane perpendicular to that axis are given by the instantaneous amplitudes of the quadrature components of difference signal.

Figure 15 shows the three projections of the imaginary solid which originally led to this speculation. The top view is the so-called "sawtooth presentation". The end view is the pointer presentation and the side

view is the pulse presentation under limited bandwidth.

A form which is easier to visualize is the skewed squirrel cage whose end view is the spoke presentation and whose top and side views are the pulse presentation. The degree and direction of skewness is a direct indication of the difference error. It is logical that one would prefer the end view in attempting to detect and correct a small amount of skewness.

Figure 16B is an oblique view of the squirrel cage which was obtained by mixing the horizontal signals for both the pulse and spoke presentations in amounts corresponding to their projection on the desired viewing plane.

The three-dimensional effect is enhanced by applying some of the spoke presentation horizontal signal as intensity modulation. The brighter traces then appear nearer. In fact, if the horizontal component of the spoke presentation is now removed entirely from the horizontal input and applied only as intensity modulation, one obtains the pulse presentation with only the "nearer" traces displayed. Both the sense and magnitude of the error is indicated by the slopes of these traces. Figure 17A and 17B illustrate this presentation for the case of a carrier which is sinewave modulated in both amplitude and frequency. In Figure 17A a zero beat is obtained at the peak of amplitude modulation while in Figure 17B the frequency is being determined at the trough.

Conclusion

The combination of transfer oscillator and precision frequency counter constitutes a system capable of rapid and accurate frequency measurements well into the microwave region.

The error in this method of frequency measurement arises in the -

- (1) comparison of a harmonic of the transfer oscillator to the carrier frequency.
- (2) determination of the transfer oscillator fundamental frequency.

Several techniques have been described which show the advantages of cathode ray tube displays in making the comparison, particularly in the case of pulse modulated signals. Quadrature detection may be employed to provide an indication of the direction of the comparison error as well as its magnitude. The choice of the particular display to be used is dictated largely by the complexity of the signal to be measured and the accuracy desired.

The accuracy of comparison in the case of pulsed rf

depends upon the product of pulse width and carrier frequency. When this product exceeds ten thousand cycles, the comparison error can be reduced to the point where a counter error of a few parts in ten million is significant.

In general, the transfer oscillator with an appropriate comparison system can be used to extend the applicability of the frequency counter to the measurement of instantaneous frequency over an extremely wide range. The accuracy of such measurements depends upon the number of rf cycles used as a sample in the comparison.

Recent developments in instrumentation have extended the measurement of the carrier frequency of RF pulses

to 18 GHz using transfer oscillator techniques. With additional equipment this range can be increased to 40 GHz. Further information is available in the February 1968 HP Journal and the E40-5245L Data sheet.

Pulsed RF can also be measured to 18 GHz directly using heterodyne converters and automatic counters having an armed mode of operation. More detail on this method can be obtained in the May 1969 HP Journal, and in data sheets on HP Model 5323A and 5360A Counters.

Acknowledgement

The authors wish to acknowledge the many helpful suggestions of Dr. B. M. Oliver.

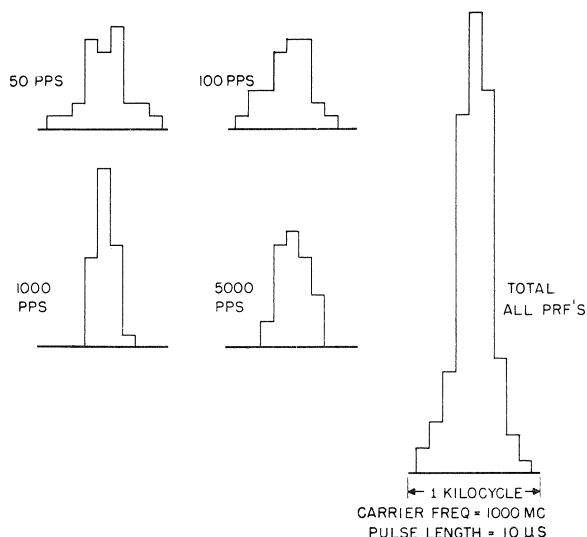

Fig. 14. Distribution of 120 readings using Spoke Presentation

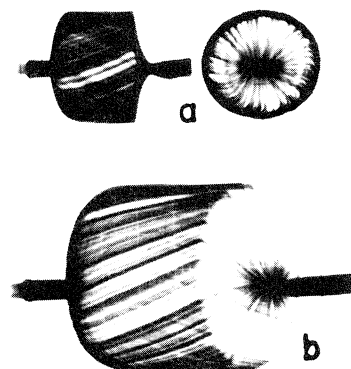

Fig. 16. "Squirrel Cage" shown in (a) side view, and (b) oblique view

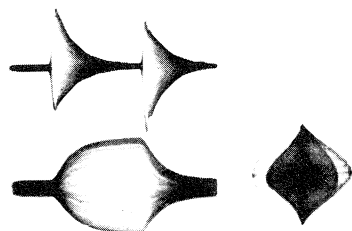

Fig. 15. Three presentations as projections of a solid figure

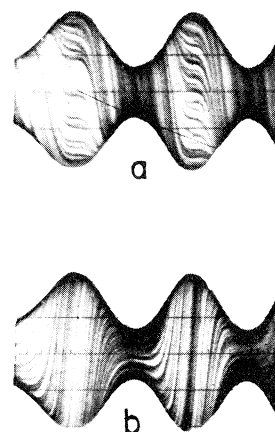

Fig. 17. Intensity modulated presentation for combination of AM and FM with zero beat at (a) peak, and (b) trough

