

THEORY AND APPLICATIONS OF WAVE ANALYZERS

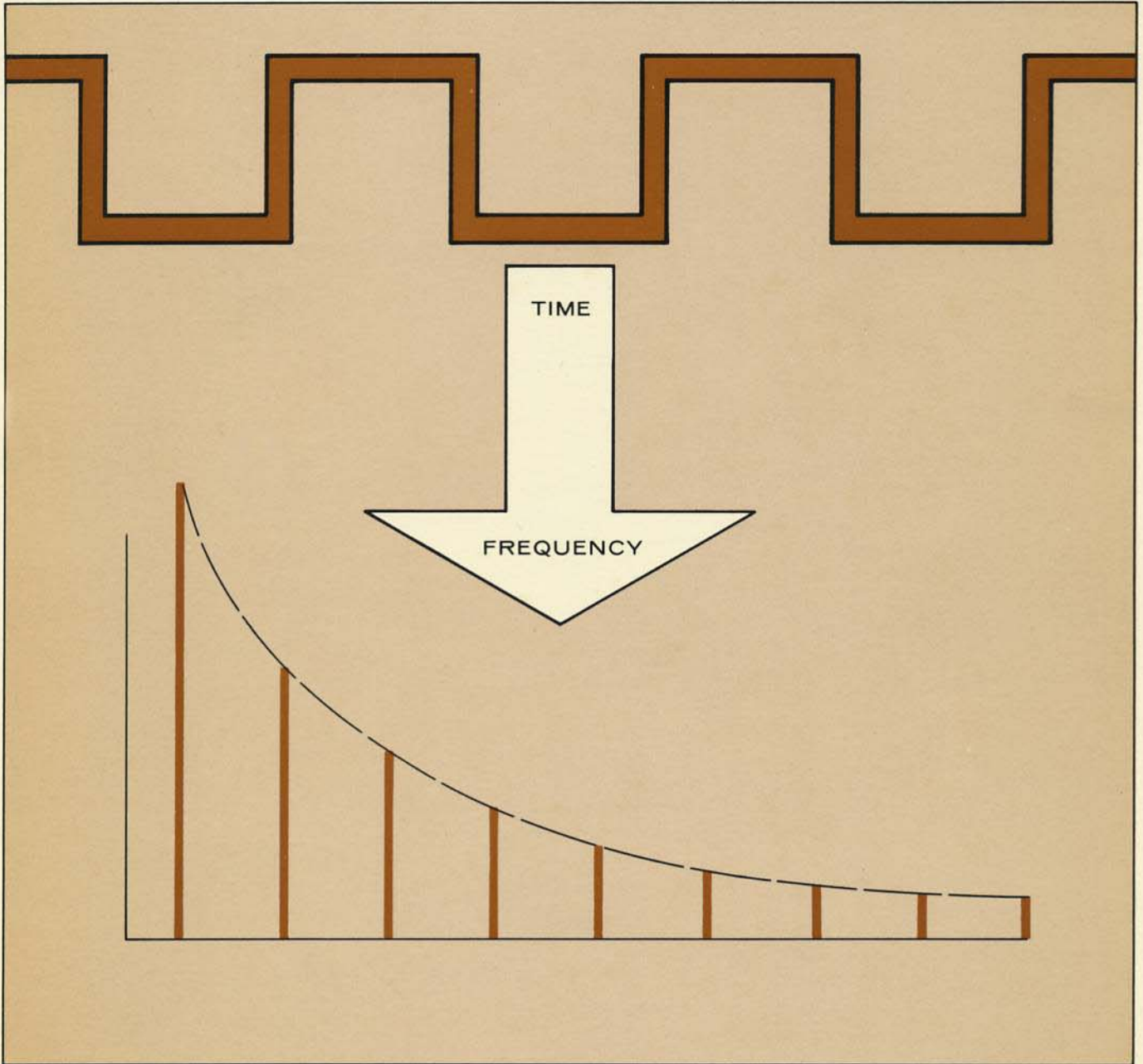

THEORY AND APPLICATIONS OF WAVE ANALYZERS

APPLICATION NOTE 126

**COPYRIGHT 1970
HEWLETT-PACKARD COMPANY
LOVELAND INSTRUMENT DIVISION
P. O. BOX 301
LOVELAND, COLORADO U. S. A.**

Table of contents

- I Introduction Pg. 1
- II Time Domain vs. Frequency Domain Pg. 2
- III Important Definitions Common to Wave Analysis Pg. 3
 - Bandwidth and Shape Factor Pg. 3
 - Dynamic Range and Display Dynamic Range Pg. 4
 - BFO, AFC, Restored, AM, USB, LSB, etc. Pg. 4
- IV Wave Analyzer Operation Pg. 4
- V Applications Pg. 6
 - Time-to-Frequency-Domain Conversion Pg. 6
 - Determination of Spectral Purity Pg. 7
 - Intermodulation Distortion Detection Pg. 8
 - Network Analysis Pg. 9
 - Power Line Distortion Pg. 11
 - Low Level Distortion Pg. 12
- VI Conclusion Pg. 13
- VII Questions and Answers. Pg. 13

I. Introduction

This note is intended as an aid to those who must measure electrical signals that range widely in level and frequency and that must be measured in the presence of other signals. That, in essence, is what wave analysis is. But it is also what spectrum analysis is, so why the term "wave analysis"? Wave analysis is different from spectrum analysis because of the methods used in the two techniques. A discussion of these methods should clear up any confusion that may exist when speaking of wave/spectrum analysis, and at the same time more clearly define wave analysis.

Wave Analysis vs. Spectrum Analysis

Wave analysis is usually performed with an instrument either manually tuned or tuned relatively slowly by electro-mechanical or electronic means. As the individual frequency signal is tuned, its level is measured and presented as either a meter deflection or an X-Y recorder pen deflection. In spectrum analysis more rapid tuning is usually employed and the level is presented as vertical deflection of a cathode ray tube beam.

Spectrum analysis provides a fairly accurate and very rapid means of evaluating all the components of a composite signal. Wave analysis takes more time but yields more accurate frequency and amplitude data.

Wave analysis techniques find useful application in situations where it is difficult, if not impossible, to evaluate a signal in the time domain; that is, by observation on an oscilloscope. Examples of such a situation might be the output of an amplifier to discover its harmonic or intermodulation distortion, or the output of a radio transmitter or oscillator for spectral purity. The complex baseband signal of a carrier system can be examined without interfering with many of the hundreds of communications channels present in the signal. These and other applications will be covered in detail in the Applications section of this note.

While many of the comments in this note apply to wave analyzers in general, it is specifically concerned with the operation and uses of the HP 3590A Wave Analyzer. There is a short section dealing with the concept of time-domain-to-frequency-domain conversion, the essential function of a wave analyzer; a section of definitions and terminology; a section giving a rather detailed description of how to use the HP 3590A; and finally, a section devoted to applications. Those familiar with the HP 3590A can omit reading the Operations section, and those well versed in time-frequency domain concepts can avoid that section. The section concerning definitions, however, should be at least scanned by all readers so that a common understanding of the various terms used in the Applications section will be obtained.

II. Time domain vs. frequency domain

The value of wave analysis (or spectrum analysis) is that it allows physical transformation from the time domain to the frequency domain. By "time domain" we mean the representation of an electrical signal as a function of time. An oscilloscope is a time domain instrument because it displays amplitude vs. time on its CRT face.

"Frequency domain" refers to representing an electrical signal as a function of frequency. A wave analyzer or spectrum analyzer is a frequency domain instrument since it provides the amplitude of a signal vs. frequency as an output.

The relationship between these two domains is well established for periodic waveforms, which can be mathematically expressed as a function of time or frequency. The mathematical basis for the correspondence between the two domains is Fourier's statement that a signal can be expressed as a DC offset and a series of sine and cosine components.

$$f(t) = \frac{a_0}{2} + \frac{2}{T} \sum_{n=1}^{\infty} (a_n \cos \omega_n t + b_n \sin \omega_n t) \text{ Eq (1)}$$

$$\text{where } \omega_n = \frac{2\pi n}{T} \quad n = 0, 1, 2, 3, \dots$$

Many symmetrical waveforms, such as a square wave, have an average value of zero and hence the term $\frac{a_0}{2}$ vanishes in Equation (1).

Equation (1) tells us that there are four quantities that must be measured to reconstruct $f(t)$. These quantities are

a_0 , ω_n , b_n , a_n . Furthermore we must do this for the full frequency spectrum. a_0 can be measured with a DC voltmeter after the AC components have been filtered out. Spectrum and wave analyzers have some means of determining ω_n . It may be distance between markers on the spectrum analyzers and a nixie or mechanical readout on the wave analyzers. As a practical matter not all ω_n may be seen. The upper and lower frequency limits of the instruments account for this limitation. The sine and cosine amplitude terms are not measured separately. This is equivalent to saying that the phase of the terms is not measured and they may be assumed to be all sine or cosine terms. The magnitude terms may have positive and negative signs. The analyzers only measure magnitude. Summarizing, analyzers have three shortcomings. They don't measure overall DC, phase, or sign of an individual component. With these basic constraints individual machines do a better or worse job of measuring magnitude and frequency. These limitations are discussed in a later section of this note. Fortunately for the user the limitations are much smaller than the benefits.

In a general application it is not important to know much more than magnitude and frequency of the components. A radio is analogous to a wave analyzer. As the dial is turned over the broadcast band stations are picked up at the frequency the dial indicates.

The magnitude of the signal is related to the loudness of the received signal. The more sophisticated wave analyzer

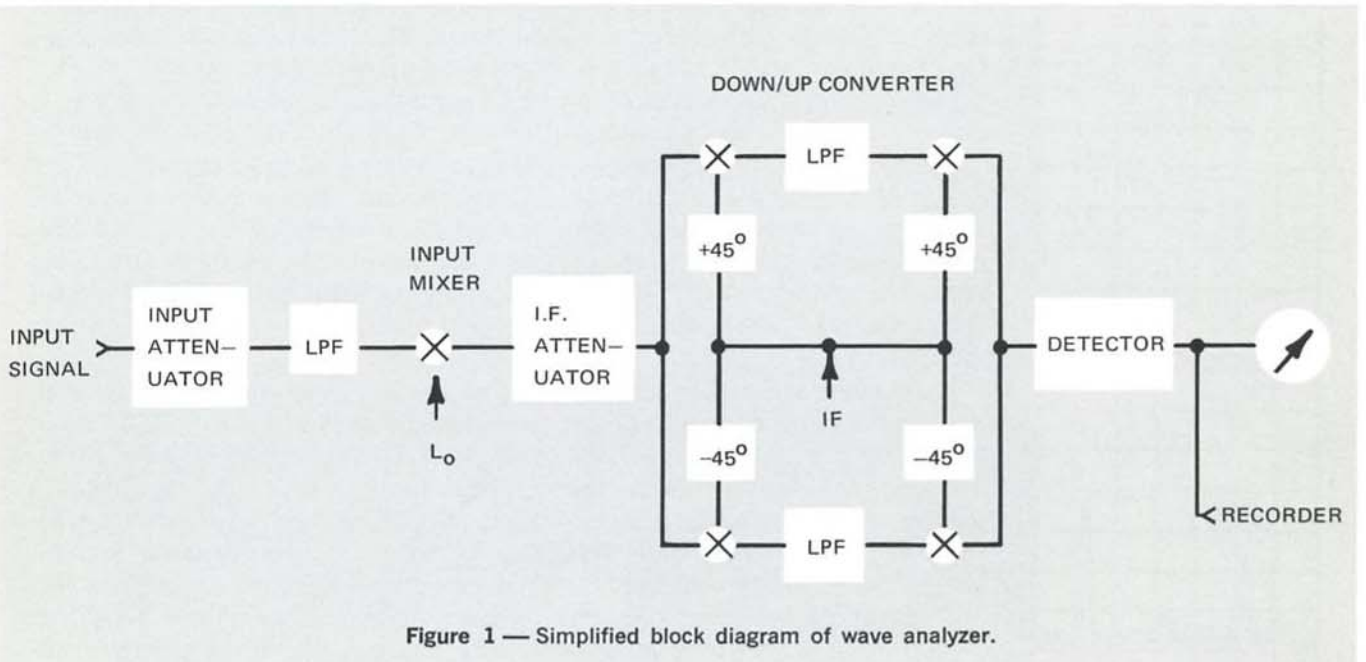

is able to determine frequency and magnitude with greater accuracy than the radio in this analogy. It is also able to do things which make it easier to operate in different uses.

Figure 1 is a simplified block diagram of a typical sophisticated wave analyzer; in this case, the HP 3590A.

Notice the input attenuator, the IF attenuator and the down/up converter. The input attenuator is not frequency selective and attenuates any and all signals introduced to the input, establishing the maximum input voltage or sensitivity for the instrument. The IF attenuator establishes the range. The two attenuators together determine the scale factors to be applied to the meter. (More will be said about this in the Operation section).

The down/up converter performs two important functions. First, it converts the IF and its sidebands to dc with the same sidebands. This permits the use of active low pass filters to provide very sharp frequency selection with an easily controlled pass band. Second, upon up converting, any upper sideband components created in the down conversion are phase cancelled because of the 45° phase shifts introduced in the down/up conversion process. The up converted result is now a sharply filtered IF containing only the frequencies of interest, which are easily detected to provide meter deflection currents or recorder output currents.

Although not shown in Figure 1, many valuable accessory circuits are often available in wave analyzers, such as: restored output, which is an amplified replica of the input signal passing through the selected bandwidth filter.; AFC,

which locks the wave analyzer to drifting input signal; AM detection; upper and lower sideband detection; automatic operation of the IF attenuator; and electronic or electro-mechanical frequency sweeping.

Why bother to examine a signal in the frequency domain when an oscilloscope will adequately measure the signal in the time domain? Why have two instruments where one might do the job? The answer is that such phenomena as harmonic distortion, which is small compared to the fundamental, simply cannot be seen with the oscilloscope.

Figure 2 compares the time domain and frequency domain output of a signal generator. Notice the time domain signal looks like a simple sinusoid but the frequency domain representation reveals higher harmonics. If a composite signal such as RF interference were viewed with a scope only, meaningless fuzz would be seen. But if this is separated into its various components, some clue to the source of the interference might be obtained.

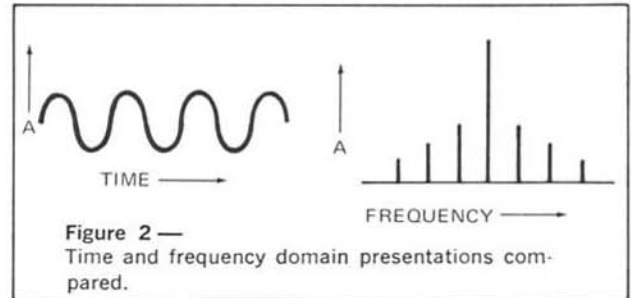

III. Important definitions common to wave analysis

If true time-domain-to-frequency-domain conversion is to be made, the wave analyzer must possess certain qualities. Certainly it must cover a range of frequencies of interest to the user and must be capable of making accurate level measurements. There are some specifications unique to wave analysis and wave analyzers. These specifications are an attempt to provide the user with the information he needs to select from competitive instruments to meet his unique needs. They are discussed below.

Bandwidth and Shape Factor

Many wave analyzers are represented as having a very narrow bandwidth in the passband, say a few cycles. This is correct but does not tell the whole story. Bandpass has the same meaning in wave analyzers as it does in other devices. The bandpass frequencies fall between the 3 dB points of amplitude. This bandpass characteristic can, of course, be moved like a window to any portion of the instrument frequency range to select the required narrow band of frequencies. This is basic to wave analyzers, as has been pointed out.

The other half of the picture, shape factor, may not be so well known or apparent. Shape factor is a dimensionless number describing the bandpass characteristics of a wave analyzer. It is the ratio of the bandwidth at the 60 dB point to the bandwidth at the 3 dB point.

This figure should ideally equal unity, but of course cannot because of limitations encountered in building filters. A crystal filter may have a shape factor of 10 while some HP wave analyzers have shape factors of 2.

Figure 3 compares two filter shapes. The -3 dB points are the same for both filters but the -60 dB points are different. Both filters pass the frequency being measured and frequencies that are not supposed to be measured. Filter 1 with the poorer shape factor will include more of the unwanted signals than the other filter. Consequentially, the true magnitude of the signal is not as large as the meter reading indicates. As the shape factor becomes larger this error will become even larger. This illustration should show that bandwidth and filter shape are of equal importance in evaluating a wave analyzer.

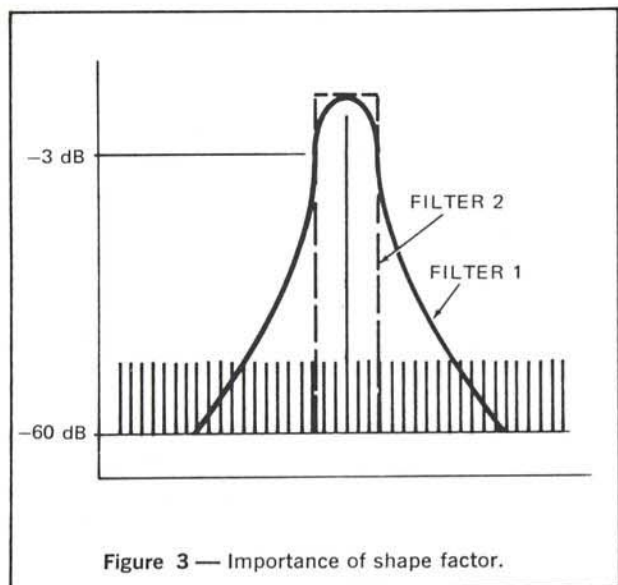

Figure 3 — Importance of shape factor.

Dynamic Range and Display Dynamic Range

Dynamic range is a measure of how small a signal can be measured in the presence of larger ones. If a wave analyzer has a dynamic range of 80 dB, then its range controls may be set so that 1 volt will cause full deflection and it will still be able to detect a 100 microvolt signal. An analyzer with 60 dB of dynamic range would only be sensitive to 1 millivolt. To achieve the full dynamic range requires IF gain control operation so that meter deflection currents are adequate. If IF ranging is automatic, the display dynamic range will equal the measurement circuit dynamic range.

BFO, AFC, Restored, AM, USB, LSB, Etc.

The abbreviations given above do not fall into the category of definitions. However, they should be described so that those unfamiliar with them are not confused.

“BFO” stands for Beat Frequency Oscillator, and when used in connection with wave analyzers means a constant level signal having a frequency the same as the frequency to which the wave analyzer is tuned. The BFO frequency of all but one HP wave analyzer (the 302A) are offset by a few cycles from the frequency to avoid falling into the notch in the center of the bandpass. The BFO level can usually be adjusted over a limited amplitude and is used as a constant level source to stimulate devices being tested. This will be more fully explained in the Application section.

“AFC” is Automatic Frequency Control, which is an auxiliary function built into wave analyzer to permit lock-on to a drifting signal.

“Restored” refers to the wave analyzer output, which is the exact frequency of the input signal to which the analyzer is tuned. A counter attached to the output jack when the analyzer is in the Restored mode will provide an accurate indication of the frequency of the signal being investigated. It is an amplified replica of the input signal passing through the selected bandwidth filter.

“AM”, “USB” and “LSB” refer to various demodulation schemes, AM meaning simple diode detection and the other two meaning the detection of the upper or lower sidebands of a suppressed carrier single sideband signal. Upper or lower sideband detection is accomplished by generating and inserting carrier signals displaced from the frequency to which the analyzer is tuned.

IV. Wave analyzer operation

This section has been included to help clear up some operator difficulties which have become evident in operating the HP 3590A. Since this instrument has so many automatic and state-of-the-art features, using it involves a bit more than merely tuning to a certain frequency and adjusting for an on-scale reading.

The principal advantage of the HP 3590A is its ability to automatically sweep in frequency on a linear or log basis. The log sweep mode has caused a certain amount of operator problems.

After initial warmup and turn on procedures, the HP 3590A with either an HP 3593A, 3594A or 3595A plug-in is ready for sweep tuning. There are four combinations of automatic sweep: lin-lin, log-lin, lin-log and log-log. The first term refers to the nature of the vertical output of the analyzer and the second term refers to the horizontal output. The vertical output will be proportional to the amplitude of the signal to which the analyzer is tuned. It should be borne in mind that the meter movement is an average

responding, rms indicating type and so for accurate indications the bandwidth of the analyzer should be narrow enough that individual sinusoids of a complex signal are selected. Otherwise, the RMS indication will not be accurate. Do not attempt to analyze a 100 Hz square wave with the analyzer set to a bandwidth of 1000 Hz.

The linear vertical output should be used for measuring signals having components similar in level. If this is done, the Max Input Level control and the Range control can be set so the full output range will represent the differences between signal levels that differ only slightly, thus providing increased resolution.

If the signal levels to be measured differ greatly, the vertical log output can be used to obtain great dynamic display range, which is linear in decibels. If a wide range of frequency and levels must be accommodated the log-log output can be used, providing “Bode plots” on the X-Y recorder to which the outputs are connected. The lin-log output might find application where the range of levels is small but the range of frequencies is large.

X-Axis Operation

A negative going voltage is available at the BNC marked X axis. This output is scaled at -0.2V/kHz on the 62 kHz range and -0.02V/kHz on the 620 kHz range. The three positions on the switch below the connector control the output. In the log position the zero output voltage corresponds to a low starting frequency. To explain why the starting frequency is not zero in the log position consider the requirements of a log sweep. In theory, such a signal (dc analog) should have a magnitude vs. frequency characteristic like that shown in Figure 4.

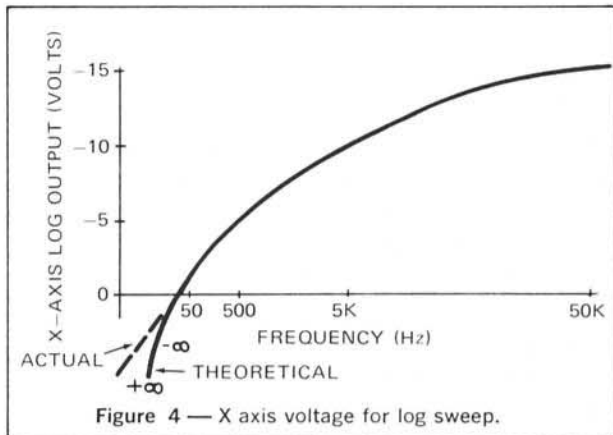

Figure 4 — X axis voltage for log sweep.

Since the negative infinity volts is impossible to attain and since 0 V output must correspond to some non-zero frequency, the actual log sweep output of the 3590A has been made to resemble the dotted position of figure 4. This means the log sweep is usable down to 50 Hz (20 Hz with the 3595A plug-in). In the linear position the output voltage corresponds to the local oscillator frequency. If the local oscillator is set to start sweeping at a frequency other than zero, the output voltage will start at something other than zero. Because this offset voltage is not always wanted, a third position has been provided. The ramp only setting will start the X axis output at 0 volts no matter what the local oscillator is set at.

Y-Axis Operation

There are two BNC's for the Y axis outputs. Two steps are required to adjust the recorder for either output. With the Y axis disconnected adjust the recorder zero to the lower line on the paper. With the Y axis connected and the meter at full scale adjust the vertical sensitivity to put the pen at the top line of the paper. The recorder is now adjusted to display 100 dB or 0 to 1 on the linear scale.

Maximum Sweep Time

Maximum sweep time is a further consideration to take into account when looking at wave analyzers. The 3593A and 3594A have 620 seconds of sweep time available. This is not a restriction when sweeping slowly over a narrow frequency range or when sweeping quickly over a wide frequency range. The 3595A has a sweep time of 10,000 seconds. With this plug-in a slow sweep over a wide fre-

quency range is possible. Why is there a need to sweep at different speeds? The answer to this question is related to the selection of different bandwidths. The narrow bandwidths require a slower sweep to respond over the 85 dB of dynamic range available.

If there weren't other considerations to take into account the sweep speed and bandwidth knobs could be tied together. If a plot is being made over this audio range with a sweep speed of 2 Hz/second, 10,000 seconds or 2-3/4 hours would be needed. In all probability the signals of interest don't cover this entire range. The areas of little interest can be swept faster because the sweep speed is a separate control. This technique can be used to reduce the total time required to plot the same frequency range.

Power Level Measurements

There are many commonly used systems of level measurements based on power levels instead of voltage levels. This requires that a reference impedance be selected. Perhaps the most common unit of power level measurement is the dBm, a logarithmic power ratio referenced to 1 mW, and more specifically, 1 mW dissipated in 600 Ω of pure resistance. When 1 mW is dissipated in 600 Ω , the rms voltage dropped across the resistor is, 0.778 V. Therefore, many voltmeter decibel scales are designed so that 0 dB on the dB scale is opposite 0.778 V rms on the voltage scale.

Since the dB scale of the 3590A is a voltage reference scale, it cannot be used to represent standard power levels unless some needle offset is introduced so that a known voltage (say 0.778 V rms) across a known resistance (say 600 Ω) is represented by an appropriate dB value (in this case, zero). To calibrate for power levels, select the reference power level (in most cases 1 mW) and the reference resistance (50, 75, 135, 150, 600 Ω , etc.) and solve the equation

$$V = \sqrt{P_o \times R} \quad (\text{Eq 2})$$

where: P_o is the reference power in watts

R is the reference resistance in ohms.

Terminate the input of the 3590A in the reference resistor and apply a reference signal to the terminated input. Adjust the level of the reference signal until the voltage obtained by solving Equation (2) is indicated. Move the Absolute/Relative switch to Relative and adjust the Ref Adj control until 0dB is indicated. Since Ref Adj can only shift the needle downscale, it will usually be necessary to switch the Range switch to a lower range. The Sensitivity and Range annunciators should be ignored, as should the voltage scale on the meter. The rear panel output will still be representative of the needle position so that +10 V at the Y axis output will be representative of the reference power level (0 dBm) selected. Likewise, levels below the reference will be represented by voltages less than +10 V. The scale factor will be 0.1 V/dB. If the BFO output is used as the reference level generator, calibrate with refer-

ence to -20 dB (0.0778 V for 1 mW into 600 Ω) because the BFO output will not provide power enough to drop the required voltage across the required impedance in many cases.

You may find the dynamic range of the instrument has been reduced by 10 dB or 20 dB when it is used for refer-

ence power levels. This is simply because the reference voltage dropped across a reference resistor is, in most cases, lower than the 1 V reference level at the 100 kΩ input impedance of the 3590A. Otherwise, the 3590A is calibrated to measure various power levels with reference to a standard power level.

V. Applications

Time-to-Frequency-Domain Conversion

The first application of the HP 3590A Wave Analyzer is more demonstrative than practical; it serves to show the time-to-frequency-domain converting ability of the instrument. The instrumentation arrangement is as shown in Figure 5. This arrangement will provide a rectangular pulse 6.6 μs in duration every 100 μs.

The pulse duration and repetition rate are the essential information needed for mathematical analysis of a known time domain function. Standard texts dealing with the subject of spectrum analysis commonly simplify Equation (3),

$$f(t) = \frac{a_0}{2} + \frac{2}{T} \sum_{n=1}^{\infty} (a_n \cos \omega_n t + b_n \sin \omega_n t) \quad \text{Eq (3)}$$

in such a way as to permit mathematical analysis of wave forms such as the one produced by the equipment setup of Figure 5. Typical of such simplifications is the expression given in Equation (4).

$$f(t) = \frac{1}{T} \sum_{n=-\infty}^{\infty} c_n \epsilon^{-j\omega_n t} \quad \text{Eq (4)}$$

$$\text{where: } c_n = \int_{-T/2}^{T/2} f(t) \epsilon^{-j\omega_n t} dt \quad \text{Eq (5)}$$

and: T = The period of f(t)

$$\omega_n = \frac{2\pi n}{T}$$

Since c_n is, in general, a complex quantity, Equation (4) may be represented more usefully as:

$$f(t) = \frac{1}{T} \sum_{n=-\infty}^{\infty} c_n \epsilon^{j(\omega_n t + \Theta_n)} \quad \text{Eq (6)}$$

Equation (6) implies negative frequency components. This is a mathematical property and for our purposes Equation (6) can be represented as:

$$f(t) = \frac{c_0}{2} + \frac{2}{T} \sum_{n=1}^{\infty} |c_n| \cos(\omega_n t + \Theta_n) \quad \text{Eq (7)}$$

The constant term is the average value of the periodic waveform or the dc component. The summation term indicates the integral multiple frequency composition of the waveform. The quantity c_n is the amplitude of each component, and Θ_n is the phase of each component. Since wave analyzers do not measure the phase angle of individual frequency components, we will be interested primarily in c_n .

The signal produced by the generator in Figure 5 would appear on an oscilloscope (in the time domain) as shown in Figure 6.

The value of c_n can be found for this waveform by assigning the proper values to Equation (5) and performing the indicated integration. This may be done by examining a single pulse and assigning values as shown in Figure 7.

Viewing the pulse train as shown in Figure 7 allows Equation (5) to be written as:

$$c_n = \int_{-\tau/2}^{\tau/2} A \epsilon^{-j\omega_n t} dt \quad \text{Eq (8)}$$

$$c_n = \frac{A\tau}{T} \frac{\sin \frac{\omega_n \tau}{2}}{\frac{\omega_n \tau}{2}} \quad \text{Eq (9)}$$

$$\text{if } x = \frac{\omega_n \tau}{2} \quad c_n = \frac{A\tau}{T} \frac{\sin x}{x} \quad \text{Eq (10)}$$

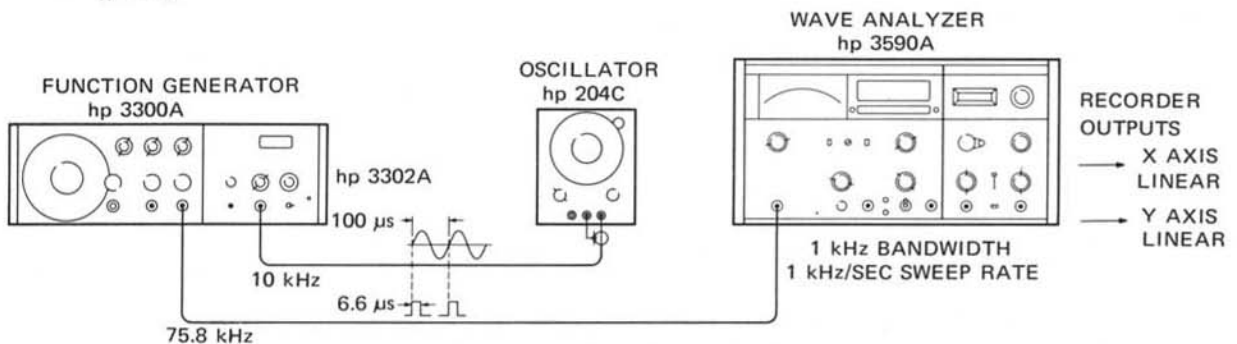

Figure 5 — Instrument setup for rectangular pulse evaluation.

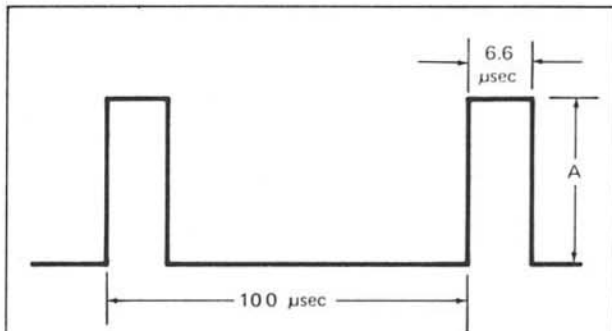

Figure 6 — Pulse train to be evaluated.

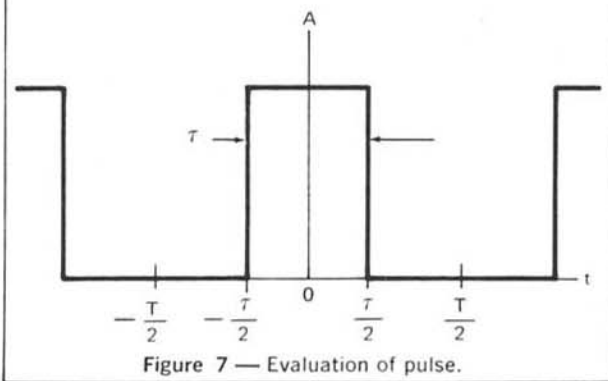

Figure 7 — Evaluation of pulse.

Equation (10) tells us that the amplitudes of the integral frequency multiples, of which the pulse train is formed, will

describe an envelope having a $\sin x/x$ shape. For $n = 0$ $c_0 = \frac{A\tau}{T}$, and when the value of n is such to make $\frac{\omega_n \tau}{2}$

approach π or multiples of π , $|c_n|$ approaches zero and abruptly changes sign as predicted by the $\sin x/x$ relationship.

However, since a wave analyzer measures only magnitude, this phenomena will be indicated by a dip in meter reading or recorder output to zero followed by a rise, which is a mirror image of the negative portion of the $\sin x/x$ function. This dip will occur at frequencies

$$\frac{1}{\tau}, \frac{2}{\tau}, \frac{3}{\tau} \dots$$

An X-Y plot of the signal we have been discussing has been made using a 3590A and is shown in Figure 8.

From the figure we see that the frequency distribution is as predicted by theory — a $\sin x/x$ envelope is described by the amplitudes of the frequency components of which the waveform is composed. We see that these are 20 kHz apart, multiples of the fundamental frequency. There is no dc component. The wave analyzer measures only ac signals. The fundamental frequency component therefore becomes the $n = 0$ component of the analysis and the frequency of the dip or sign change is $\frac{1}{\tau} = 151$ kHz away from the 10 kHz fundamental.

Determination of Spectral Purity

This application is a bit more practical. Connect a generator, the spectral purity of which is to be examined,

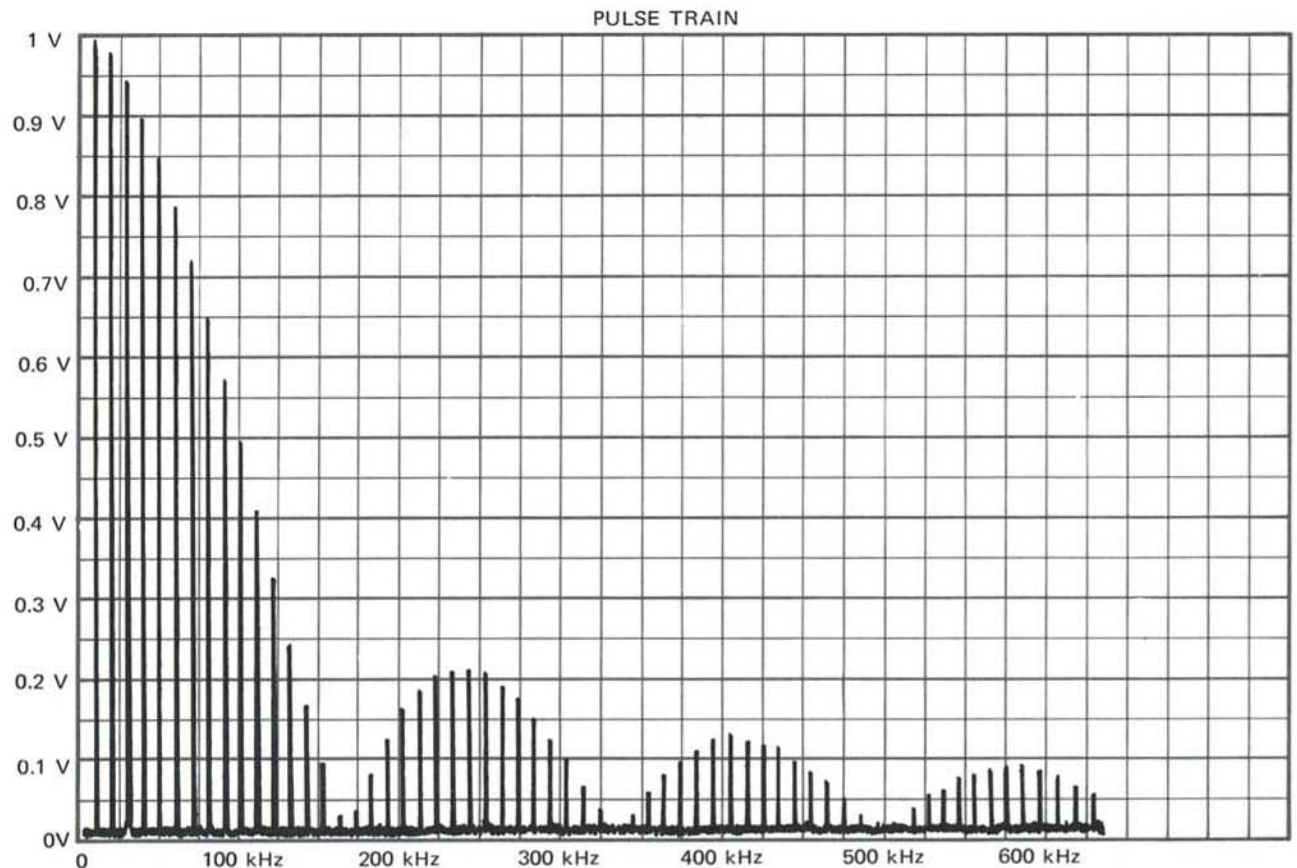

Figure 8 — Fourier analysis of pulse train.

- to the input. Adjust the generator for maximum output and the 3590A Max Input Voltage control to accommodate this level. For convenience, adjust the generator level to obtain a 0 dB reading on the 3590A after tuning it to the generator's frequency. Use log Y axis output and linear X axis output. Adjust the Y axis for 10 dB/cm by setting the X-Y recorder Y axis sensitivity to 1 V/inch.

Set the pen to a reference 0 dB position by means of the Y axis zero control. Adjust the X axis sensitivity to obtain the frequency scale factor required, switching to Ramp Only if zero frequency is not to be the starting frequency. Tune the 3590A to zero and use the X-Y zero control to register the pen at the left hand margin of the graph paper or wherever the pen is to start. Now simply switch the Sweep control to Start and the spectral purity of the generator will be indicated by the trace on the X-Y recorder.

An example of the results of such a test are shown in Figure 9.

The same type setup can be used to detect the magnitude of line-related outputs, which are usually an unwanted part of a generator's output. Since these components are multiples of 60 Hz away from the output. The Ramp Only function of the X axis output should be selected. This will allow expansion of the recording around the frequency of interest so that the required resolution can be obtained. Tune to the frequency and establish a 0 dB reference level as before, then increase the sensitivity of the X-Y recorder

until the scale is several hundred Hz/inch. For 1000 Hz/inch on the 62 kHz range, a recorder sensitivity of 0.2V/inch is required.

Figure 10 shows an X-Y plot of 1 kHz oscillator output. The scale is 240 Hz/inch. Note the odd harmonics of the power line frequency are suppressed but the even ones are present.

Intermodulation Distortion Detection

When an electronic device such as an amplifier is non-linear, its output will contain unwanted sum and difference frequencies produced from the signals that the device is designed to process. This is a form of distortion and is known as intermodulation distortion. The 3590A is ideally suited to detecting and measuring such signals since it is able to examine frequency components one at a time. Intermodulation products are almost impossible to detect, let alone measure, on a time domain basis.

Figure 11 shows an equipment setup that can be used to test for intermodulation distortion.

In the example shown, the amplifier was very linear within its normal operating range and therefore had to be overdriven to obtain non-linear operation. The calibration of the 3590A is as in previous examples; that is, setting a Y axis scale factor of 10 dB/inch, establishing a 0 dB reference level and calibrating the X axis for linear sweep starting at zero frequency.

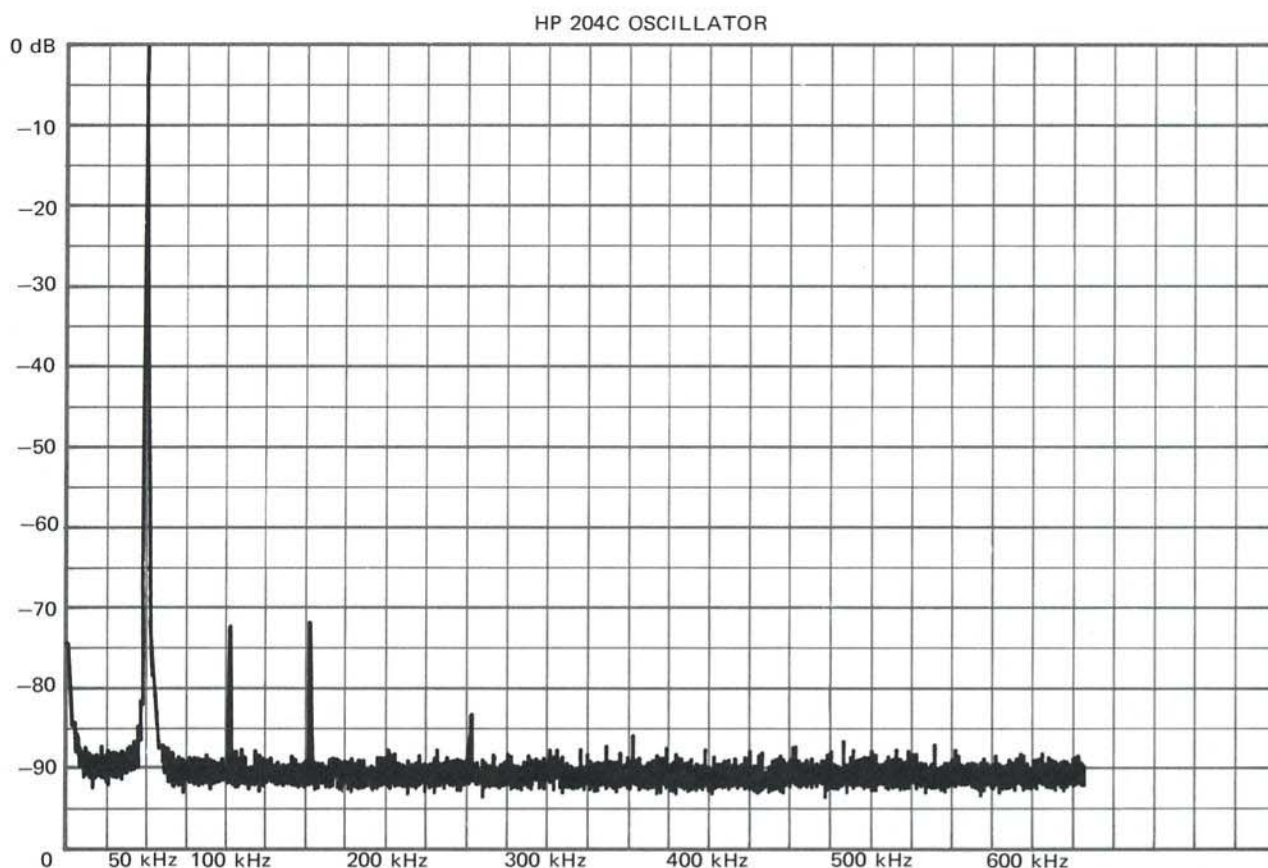

Figure 9 — Generator spectral purity.

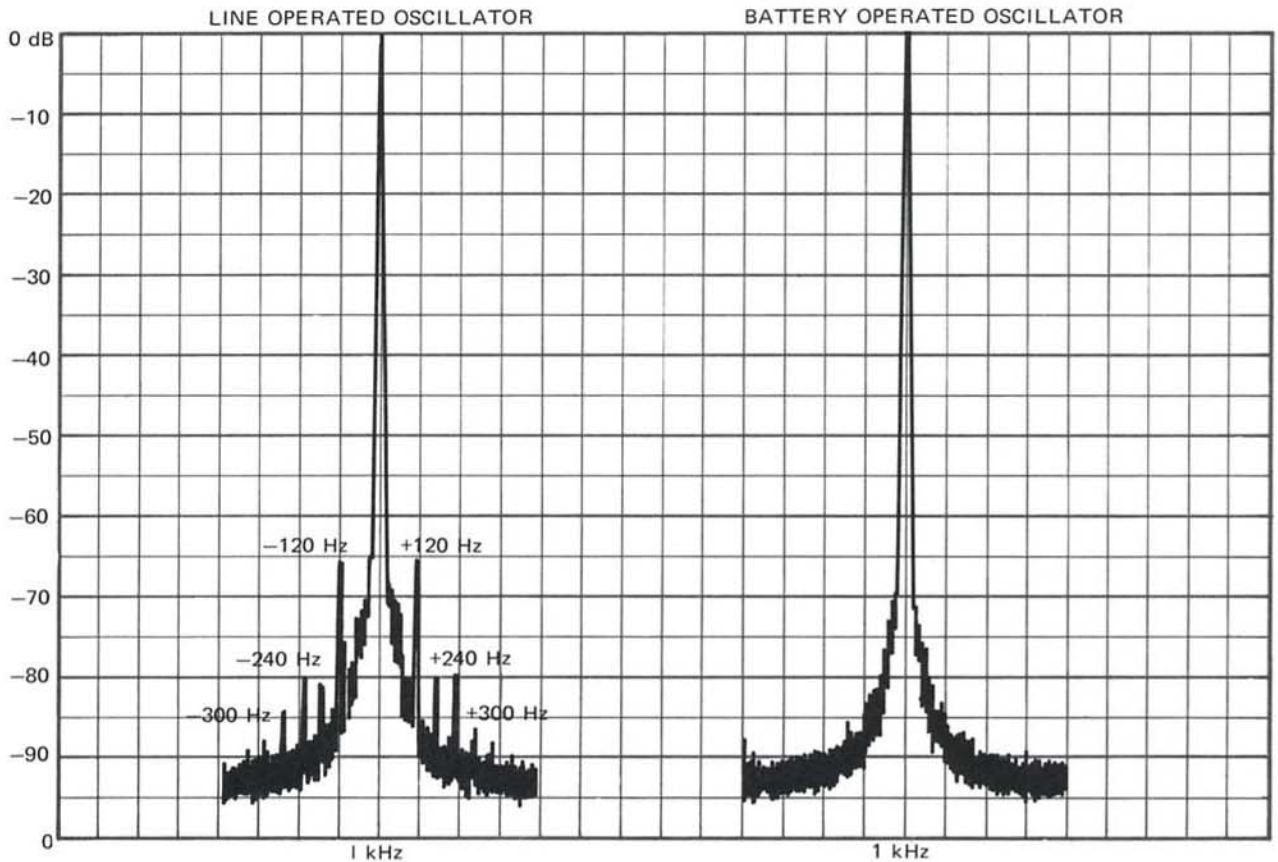

Figure 10 — Power line harmonic components in the output on an oscillator.

Figure 12 shows a plot of the output of the overdriven amplifier. We see from this plot how large intermodulation distortion is. We not only have a simple difference between the frequencies, but also differences between the second harmonics and the fundamentals. If the frequency range were greater, we would also see sums as well as other combinations.

We are, of course, using only two frequencies. In practice, any number of components might be present, giving rise to infinite combinations.

Network Analysis

Although the function of a wave analyzer is primarily to measure the frequency content of unknown signals, it may also be used to measure the frequency response of unknown networks, if a signal of constant amplitude and of

the same frequency to which the analyzer is tuned is applied to the input of the network in question and the output of the network is applied to the wave analyzer. This extremely useful aspect of wave analysis is accomplished by providing a BFO output from the wave analyzer.

As explained in Section III, the BFO output is simply a signal of constant amplitude with a frequency derived from the wave analyzer tuning circuits. This eliminates the need to tune two instruments. Just tune the wave analyzer manually or automatically, and the BFO automatically follows at precisely the right frequency. This is even more valuable when using the 10 Hz bandwidth.

It would be extremely tedious to manually stay within a 10 Hz bandwidth if the oscillator and/or wave analyzer were drifting a few Hz. The 3590A BFO output is auto-

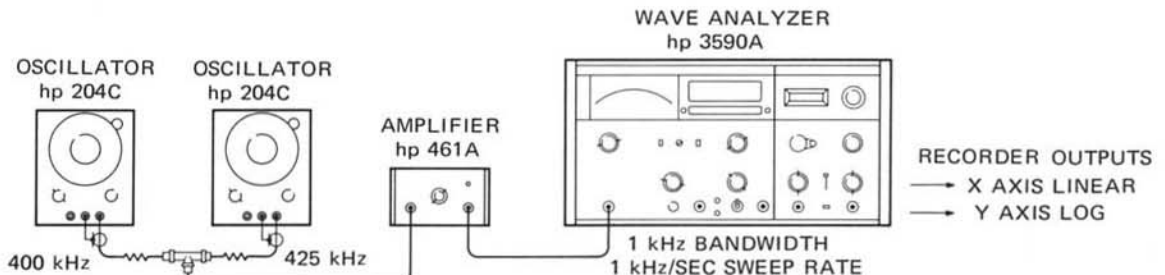

Figure 11 — Intermodulation distortion measurement setup.

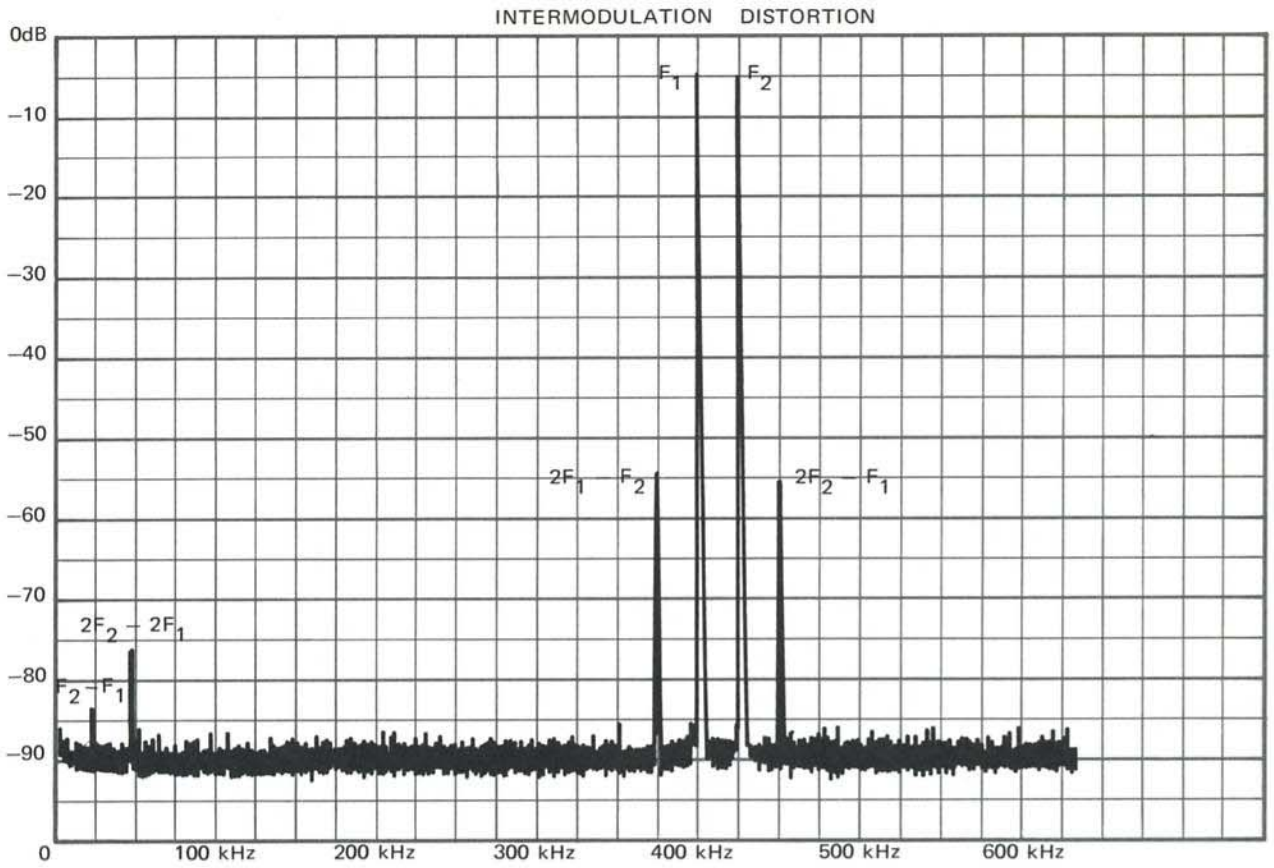

Figure 12 — Intermodulation distortion in an amplifier.

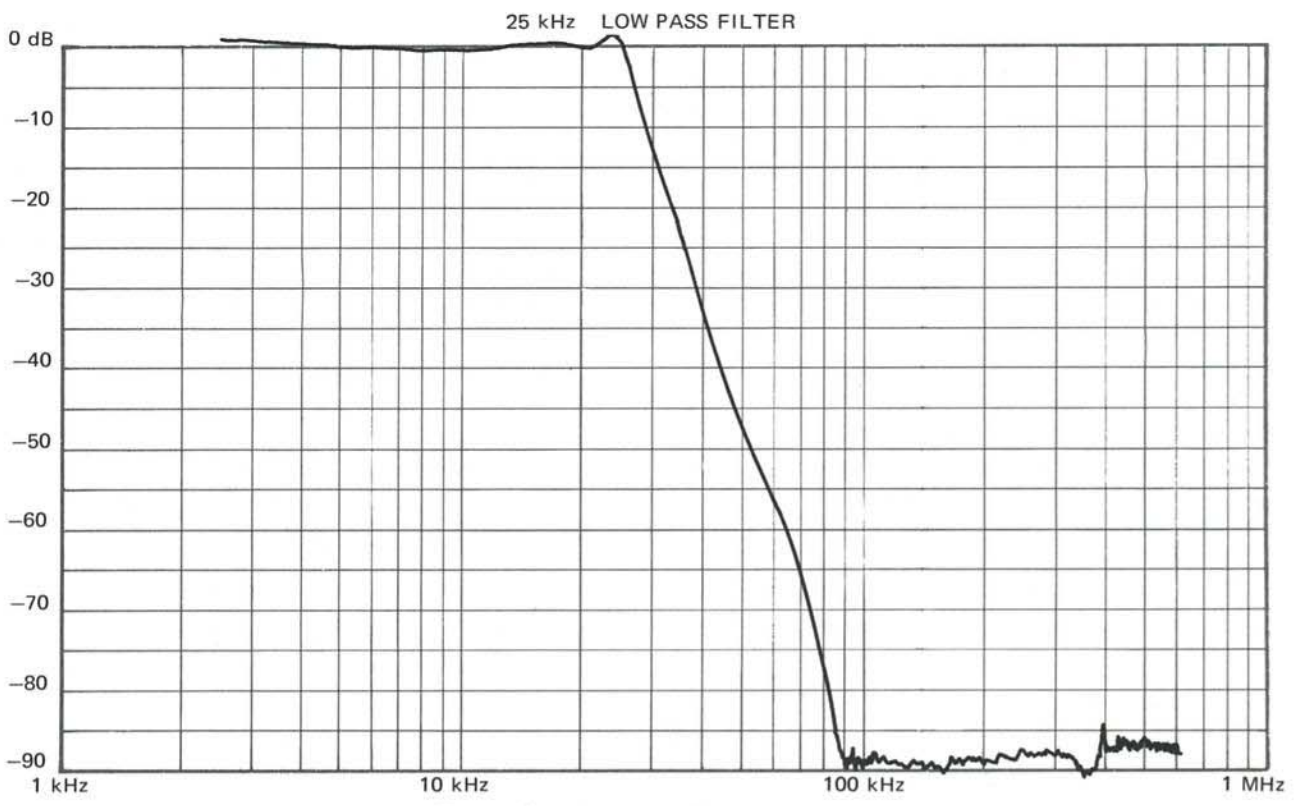

Figure 13 — Low pass filter response.

matically offset (2 Hz on the 10 Hz bandwidth and 20 Hz on all other bandwidths) to avoid falling into the notch marking the center of the analyzer's tunable filter.

Perhaps the simplest network is a low pass passive filter. The frequency response of this filter is often required information. The normal method of finding this response is to supply test signals to the input of the filter and measure the output using a broadband ac voltmeter, observing, of course, the necessary terminating requirements. This point-by-point approach is not only time consuming, it misses much in the way of information. Data between points is completely unknown and the dynamic range of the measurement is usually limited by noise at the input to the meter, which masks the response when a large amount of attenuation is present.

The BFO/wave analyzer approach is an improvement, especially in terms of dynamic range, but is still essentially a time-consuming, point-by-point approach. The 3590A with automatic electronic sweep and 85 dB of dynamic range eliminates the drudgery, reduces the time, and yields a permanent continuous record of the frequency response of the device. A plot of a low pass filter is shown in Figure 13.

In the plot shown in Figure 13, the log X axis output was used along with the log Y axis output producing the familiar Bode plot.

Although the example is of a passive filter, active filters may also be analyzed. The low frequency capability of the 3590A particularly suits it to the measurement of active filter response since these are commonly used at very low frequencies.

Power Line Distortion

The power line is a rich source of harmonics. The accompanying plot shows the strength of the third and fifth harmonics. From this plot of an average power line it can also be seen that the harmonics are present out to 2 kHz. If the generator can be characterized as a pure source, then the harmonics present are related to a non-linear load. Transformers are one element that can be non-linear. Part of the harmonics power is wasted in transformer heatings. Therefore the information about harmonics can be used to determine when more efficient equipment is needed to replace the old equipment. The user may be interested in the distortion received. The harmonics can cause overheating in some equipment. Another area of user interest would be in line filtering. In some instances filtering the fundamental will not remove all the line related interference. The 3590A/3595A has a 10 Hz bandwidth so the 60 Hz harmonics are well separated. The 3595A has the long sweep time needed look at a wide frequency spectrum.

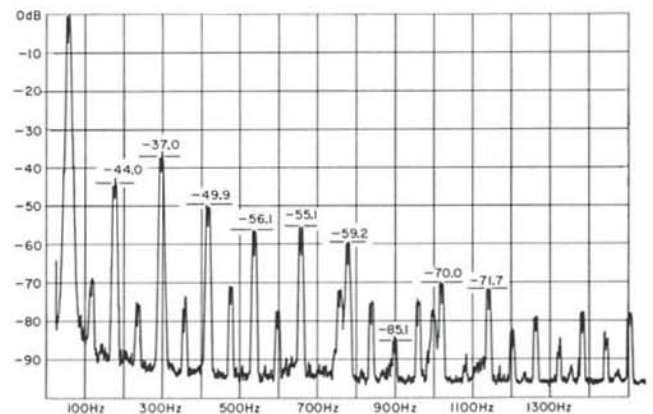

Figure 14 — Typical Power line distortion.

Low Level Distortion

The 3590A has an 85 dB dynamic range. In some distortion applications, greater range is needed. It is possible to analyze distortion that is 100 dB smaller than the fundamental. This is possible if the amplitude of the fundamental can be reduced 15 dB without reducing the amplitude of the distortion products. A band reject filter can be used to reduce the fundamental without reducing the distortion products.

The requirements of the filter are not severe. The depth of the band reject filter corresponds to the improvement in the range of the wave analyzer. This is not a process without limit. This amount of rejection that is possible in a narrow notch with a drifting signal becomes a limiting factor. One requirement of the filter is that it shouldn't add distortion products and its noise level should be as low as the wave analyzers noise level. The width of the band reject filter should be narrow so distortion which is close to the fundamental frequency is not reduced. To include all the distortion products the pass bandwidth of the filter should be large enough. The accompanying plot shows the results of such a measurement. The notch has removed 30.5 dB of fundamental. The distortion products are below those which can be seen with the 3590A alone.

With the fundamental removed, the voltage level of the distortion must fall within the input voltage limits of the wave analyzer.

The Twin T filter and amplifier are shown in the typical measurement setup. The filter is in the feedback loop to increase the Q of the filter. To achieve a large amount of fundamental rejection the filter components must be closely matched. To calibrate the amplitude of the distortion products the fundamental has to be measured before and after it goes through the filter. By changing the input attenuator of the 3590A the fundamental can be measured over a wide range.

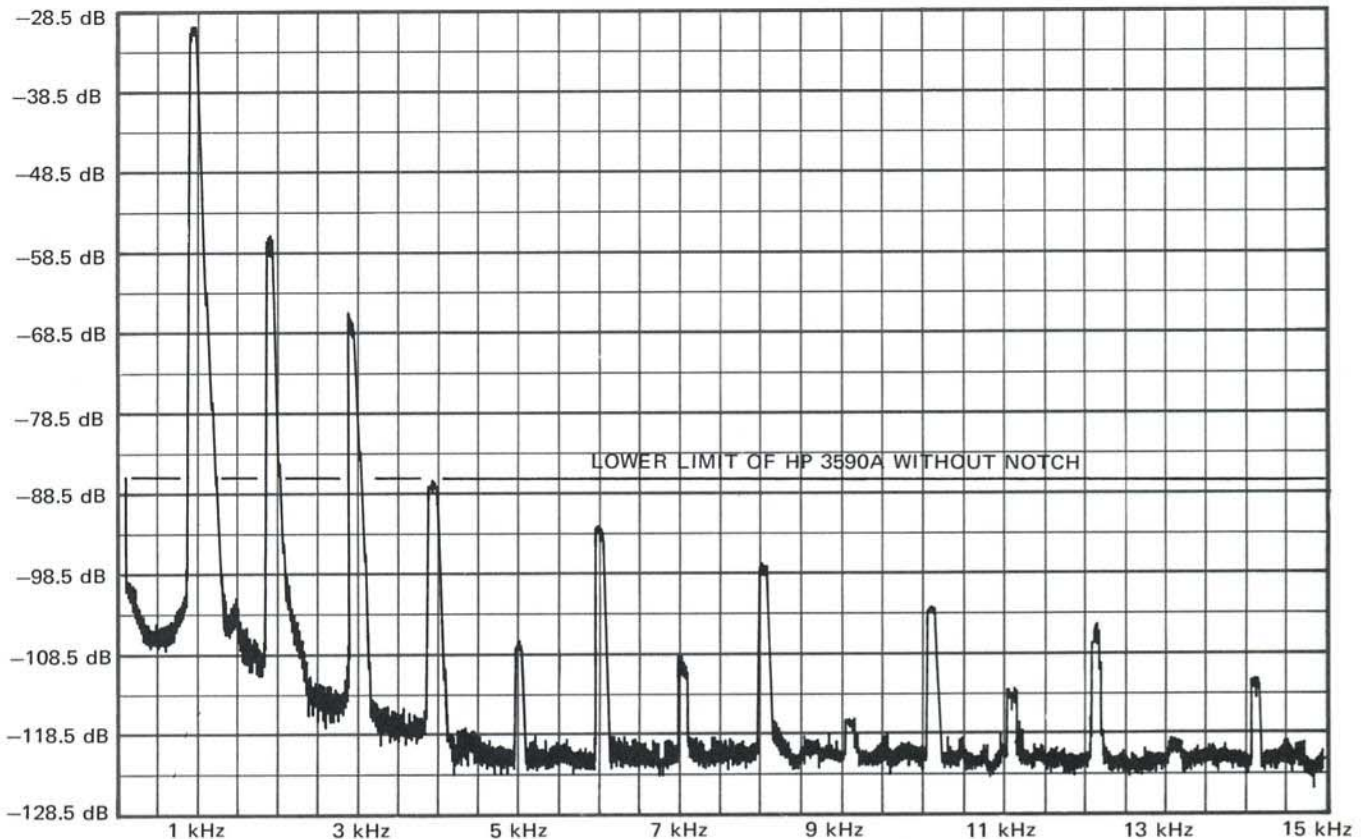
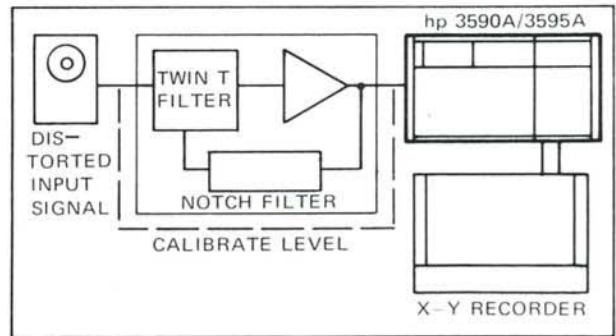

Figure 15 — Low level oscillator distortion.

VI. Conclusion

This note has been written to point out some of the common applications for which wave analyzers are particularly well suited. Specifically it was intended as an aid to the owners and users of HP 3590A Wave Analyzers, so that they might be able to realize all of the potential of this

sophisticated instrument. The applications were by no means exhaustive; and the operating section, it is hoped, will enable operators to discover many more useful and subtle applications for this instrument which can only be generated under the pressure of necessity.

VII. Questions and answers

Q. Can the 10 Hz bandwidth be used in the 620 kHz range?

A. Yes and No. The 10 Hz bandwidth is recommended only on the 62 kHz range if the internal local oscillator (3593A, 3594A and 3595A) is used. In cases where a frequency synthesizer or other very stable external L.O. is used, the 10 Hz bandwidth can be used up to 620 kHz.

Q. Why can't wave analyzers tune and measure down to dc?

A. As an analyzer is tuned down to frequencies lower than its specified range, it begins to measure what is called "zero response" even though no signal is present at the input. This response can be imagined as the

measurement of a signal located at dc. As the filter sweeps down to dc, the above response is recorded which is an image of the filter shape. Since this response is generated internally in the analyzer, it will always be present to limit very low frequency measurements.

Q. Can the 3590A be used below 20 Hz?

A. Yes. However the user sacrifices dynamic range. As long as the signal is above the zero response curve, it can be measured by the analyzer. Caution must be taken to prevent an erroneous reading such as discussed in the questions about selectivity. The signal centered in the passband must be larger than the imagin-

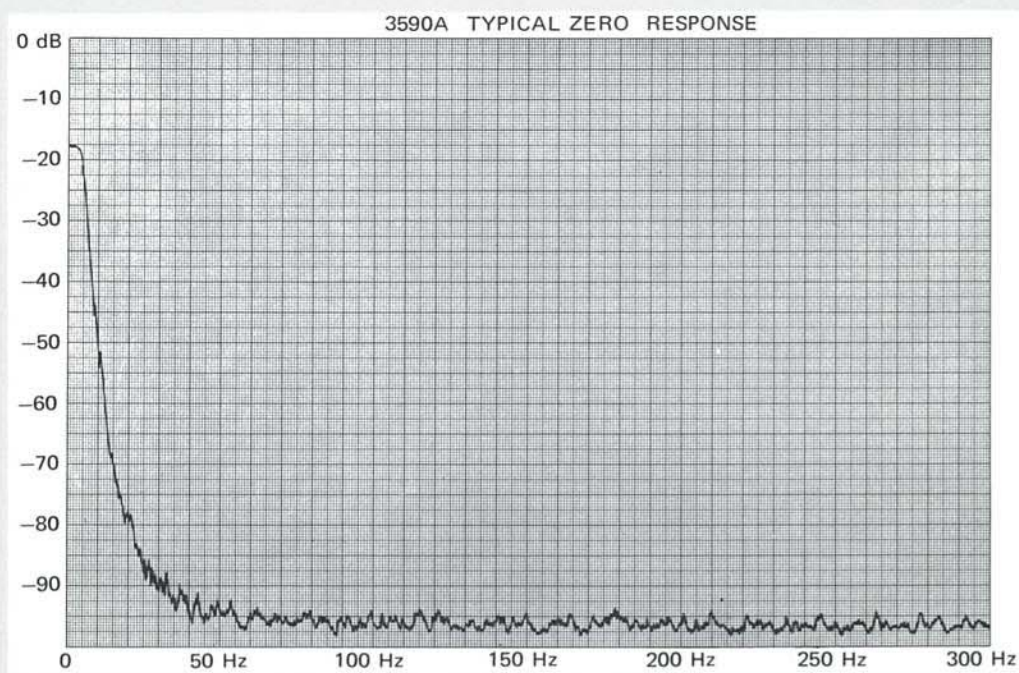

ary dc amplitude if it is to be measured accurately. A suggestion would be to make a recording of the zero response and then be sure that the low frequency signal under study is at least 20 dB above zero response to insure minimum error.

Q. *Can the 3590A be used to measure signals higher than 620 kHz?*

A. Yes. By using balanced mixers to beat high frequency signals down to the 3590A's frequency range, signal FM'ing can be detected. Note the 60 Hz side band of the 30 MHz signal shown in the applications section.

Q. *What are the advantages of using active filters?*

A. Active filtering allows better shaping to be designed into the bandpass. The 3590A has a filter top which is within $\pm 1\%$ for more than 50% of its spread and steeper skirts than crystal filtered wave analyzers.

Q. *What advantage does a flat bandpass top have over a rounded one?*

A. If the bandpass has a rounded top and is detuned slightly, an error in the amplitude reading will result. If the flat bandpass is detuned slightly, there will be virtually no error caused.

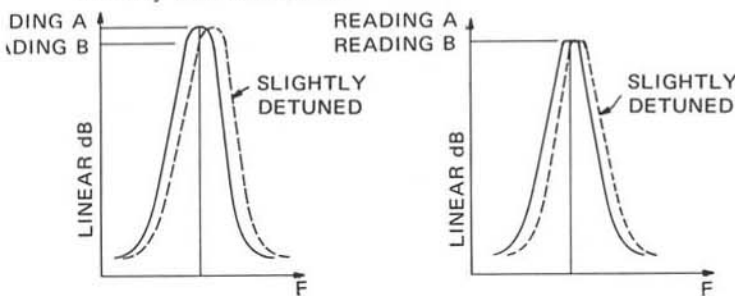

Q. *Do active filters have any disadvantages?*

A. One - the center frequency notch. This notch is constant for all bandwidths and is typically less than 1 Hz wide at -3 dB and 2 Hz at the top. When the analyzer is tuned exactly to the signal, the signal can fall into the notch, resulting in a low or erratic reading. However, the AFC can overcome the problem by keeping the signal tuned out of the notch.

Q. *Is there any advantage in having the notch?*

A. Yes. Because the notch is centered exactly in the middle of the passband, it represents the exact tuned frequency. Therefore, by tuning the analyzer so the signal is in the notch, the user can determine the exact frequency of the signal.

Q. *What warm-up time is required before the 3590A is within specification?*

A. This question must be answered in two parts. First, from a cold start, the instrument should be turned on for a minimum of 3 hours before the L.O. is stable enough to permit 10 Hz bandwidth operation. Turn

on from STANDBY greatly reduces the warm-up time needed, but 1 hour should be allowed. In both cases, however, the 3590A can be used immediately from turn on if long term drift is expected and compensated for.

Secondly, amplitude stability requires an even longer warm-up time. From a cold start, a 3% error is present which will gradually decrease over the following four hours, allowing good short term stability. Because the error decline rate is so gradual, the instrument can be calibrated at cold start and used with confidence for at least an hour at a time.

Q. *What L.O. stability can be expected after the instrument has been turned on for a day?*

A. When the instrument is operated on the 62 kHz range, the L.O. may drift $\pm .5$ Hz over a five minute period. If the 620 kHz range is used, the drift is multiplied by 10.

Q. *Why is there an OFF position on the sweep slide switch when the sweep can't be started until the lever switch is thrown to START?*

A. Because L.O. stability is improved when the SWEEP slide switch is set to OFF. The reason for this is that the sweep ramp voltage, which is close to zero, is added to the VTO when the switch is set to ON and the level drifts. Since the ramp generator is not temperature controlled, it is susceptible to ambient temperature drifts, which results in less L.O. stability.

Q. *Is a frequency offset caused by switching the sweep switch from OFF to ON?*

A. Yes. This problem is caused by the sweep ramp technique used, but it is an easy one to adjust to - set the slide switch to ON before the start frequency is set.

Q. *Do frequency offsets occur if the SWP RATE control is switched from rate to rate?*

A. Yes, on the 3593A and 3594A. No, on the 3595A.

Q. *Can the sweep be stopped at a particular frequency to more closely examine a signal of interest.*

A. No, but if a 3594A Plug-in is being used, the frequency at any given time during the sweep can be noted and the operator can manually tune to it for closer inspection. When using an X-Y recorder the X axis is a permanent recording of the same frequency information the 3594A readout displays.

Q. *What recorders are recommended for use with the 3590A?*

A. The HP 7005B (11 x 17 inch) and the 7035B (8 1/2 x 11 inch) are recommended as being adequate and have a low price.

Q. *Can strip chart recorders be used with the 3590A?*

A. Yes, but frequency may not be calibrated to the paper grid.



LOVELAND INSTRUMENT DIVISION

Printed in U.S.A.

NOVEMBER 1970

5952-2187

For more information, call your local HP Sales Office or East (201) 265-5000 • Midwest (312) 677-0400 • South (404) 436-6181
West (213) 877-1282. Or, write: Hewlett-Packard, 1501 Page Mill Road, Palo Alto, California 94304. In Europe, 1217 Meyrin-Geneva