

# Agilent High Precision Time Domain Reflectometry

Application Note 1304-7

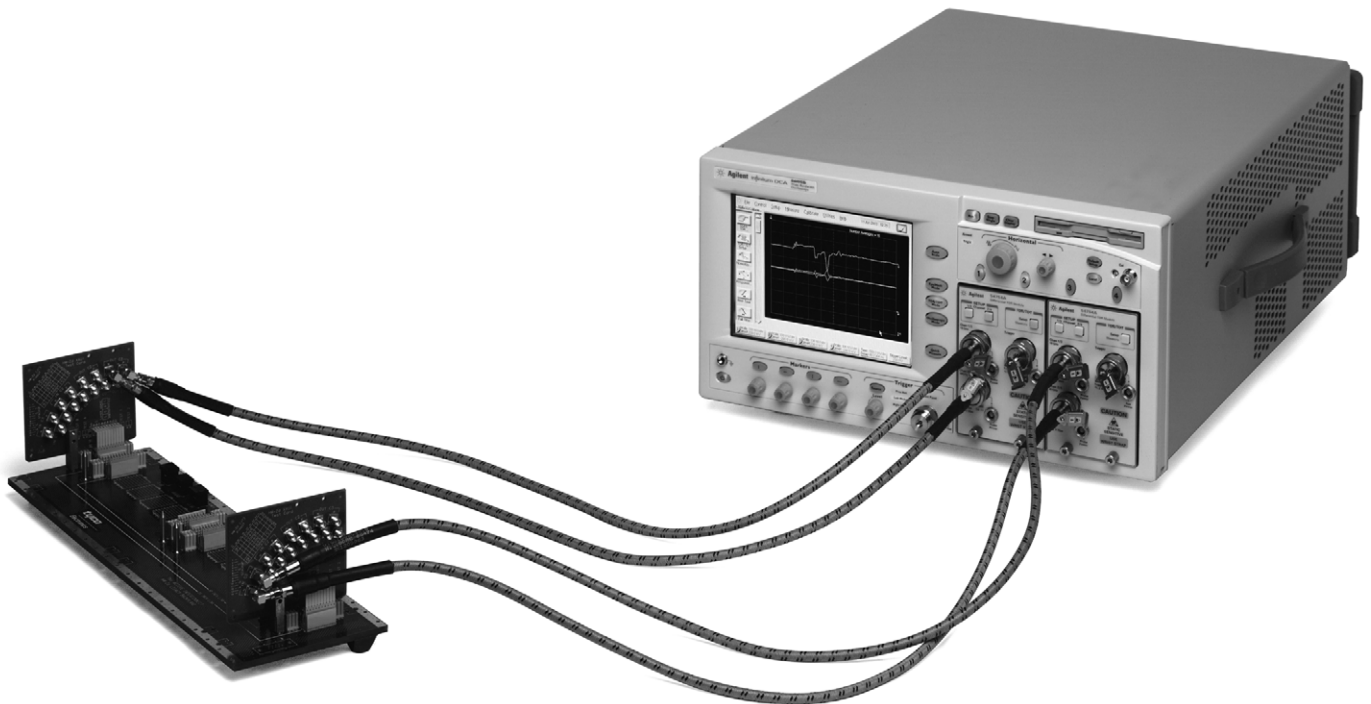

Techniques for achieving the  
highest possible accuracy and  
resolution in signal integrity  
impedance measurements



Agilent Technologies

## Introduction

High performance communications systems require a quality transmission path for electrical signals. For efficient signal flow and high signal integrity, the transmission path impedance should be kept as close to a constant, ideal value as possible. Time Domain Reflectometry (TDR) is a well-established technique for verifying the impedance and quality of signal paths in components, interconnects, and transmission lines.

As data rates increase and component geometries decrease, the precision and resolution of the basic TDR measurement system can be strained. This application note will review measurement system limitations and the sources of measurement errors. Practical techniques and useful methods to enhance precision will be reviewed.

Specific topics include:

- Techniques to remove the effects of fixturing (cabling and connections that obscure the analysis of the test component)
- Methods to improve the TDR performance to resolve closely spaced reflection sites
- Generating faster stimulus pulses to better simulate actual usage (yielding better reflection magnitude assessments)
- A methodology for high-accuracy TDR testing of differential transmission systems
- Deriving one, two, or four port S-parameters for key insights into component performance and enhanced modeling accuracy

Some of the topics discussed require additional software and/or hardware beyond the standard 86100/54754 TDR system, while others utilize standard capabilities within the system.

## Time Domain Reflectometry: Measurement Basics

When a signal is launched along a transmission path, ideally, none of that signal will be reflected back to the signal source and all the signal energy reaches its intended destination. This will be the case when the impedance of the entire transmission path and the line termination are equal to the output impedance of the signal source. However, if the signal ever encounters a change in impedance, some portion of the incident signal will be reflected.

A time-domain reflectometer (TDR) is a measurement tool used to measure the impedance profile of a component (device) under test (DUT). The concept is straightforward. Using a step generator and an oscilloscope, a fast pulse edge is launched into the DUT. Whenever there is an impedance discontinuity, a portion of the pulse will be sent back to the monitoring oscilloscope. The position of the discontinuity is determined by monitoring the time at which the reflected signal arrives back at the oscilloscope (along with the propagation velocity of the pulse within the

DUT). The magnitude of the discontinuity can be determined from the size of the reflected pulse compared to the original pulse sent into the DUT. Thus this “echo technique” reveals at a glance any changes in impedance along the line. Analysis techniques exist to show the nature (resistive, inductive, or capacitive) of each discontinuity along the line and whether attenuation in a transmission system is from series losses or shunt losses. All of this information is immediately available from the oscilloscope’s display. Since the fast pulse step stimulus is broadband, TDR gives meaningful information concerning the broadband response of a transmission system as opposed to testing over the fixed range of frequencies employed by other reflectometer methods.

An example of the equipment configuration making up the TDR and some illustrative measurement results are shown in Figure 1.

For an extensive tutorial on the basics of TDR, please refer to Agilent Technologies Application Note 1304-2 “Time Domain Reflectometry Theory”.

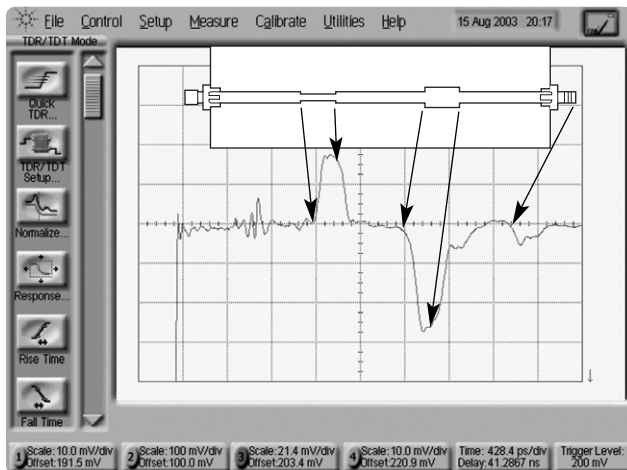
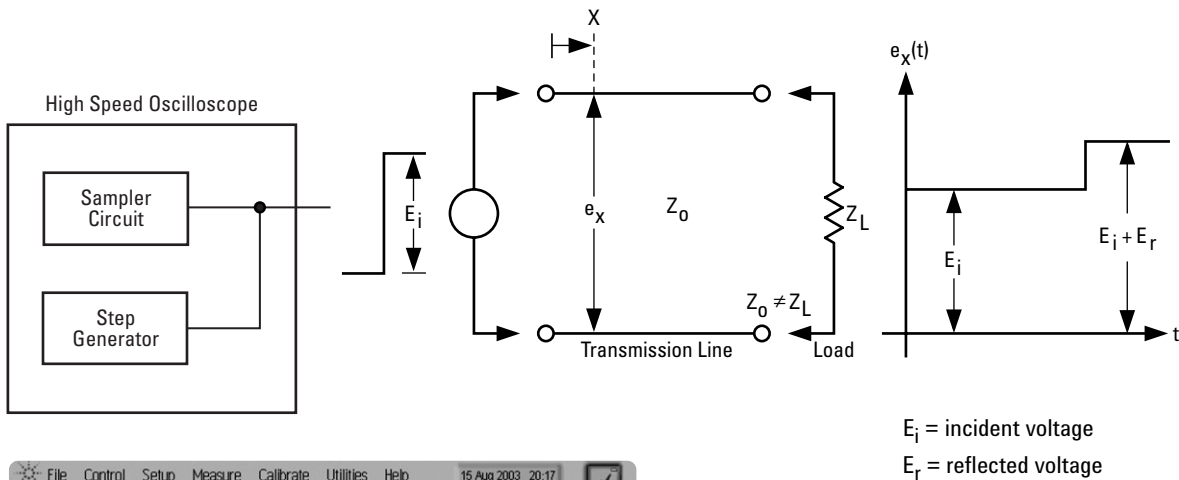

Figure 1: Basic TDR concepts.

## TDR Measurement Limitations

Fundamental performance of the TDR system determines the measurement capabilities. Consider the following factors that dictate the overall performance of the TDR system:

### The step generator as an error source

The shape of the step stimulus is important for accurate TDR/TDT measurements. The DUT responds not only to the step, but also to the aberrations on the step such as overshoot and nonflatness.

If the overshoot is substantial, the DUT's response can be more difficult to interpret. Impedance discontinuities are observed as changes in the reflected signal. Aberrations in the TDR step may be incorrectly interpreted as DUT imperfections. If the step is flat, guesswork is minimized. The risetime of the step is also extremely important. To determine how the DUT will actually respond, you should test it at edge speeds similar to those it will actually encounter.

Edge speed is also critical when using TDR to locate the source of a discontinuity along a transmission line. Both the bandwidth of the oscilloscope and the risetime of the step source can limit measurement accuracy. The risetime of the overall measurement system is the combined risetimes of the oscilloscope and the step generator. It can be approximated by Equation 1.

$$\text{Equation 1: } t_{r_{\text{system}}} = \sqrt{t_{r_{\text{step}}}^2 + t_{r_{\text{scope}}}^2}$$

A real system has a finite risetime, which acts as a lowpass filter. If the measurement system is too slow, the true nature of the discontinuity may be disguised or may not even be visible. The TDR may actually be too fast and yield results that are not applicable to actual usage. (Typically, reflection performance changes with edgespeed because reflections are frequency dependent. This is easily observed with a return loss measurement on a network analyzer. When the amount of signal reflected is measured as a function of frequency, it is common to see that as frequency is increased, the magnitude of signal reflected back from a DUT increases.) Notice in Figure 2, a measurement of a 50 Ohm SMA to BNC adapter, that as the risetime of the step stimulus is decreased, the nature of the reflection from the DUT if used at high data rates becomes more apparent. At a 100 ps step speed, there is only one reflection seen at about 56 Ohms. When the edgespeed is increased to 35 ps, more reflection sites are observed, with the dominant site at 71 Ohms. At a step speed of 20 ps, the impedance discontinuity increases to over 77 Ohms. In the case of the three measurements, the results obtained using a 20 ps risetime step stimulus do not apply for a connector that sees edges that are always slower than 100 ps in actual usage. Thus the

connector might be acceptable for 100 ps edges but not for 20 ps edges. On the other hand, systems operating at or above 10 Gb/s will involve signals with risetimes perhaps below 30 ps. Components for 40 Gb/s transmission may see edges under 10 ps. Thus a TDR with a flexible edgespeed can be useful when components used at a variety of data rates need to be analyzed.

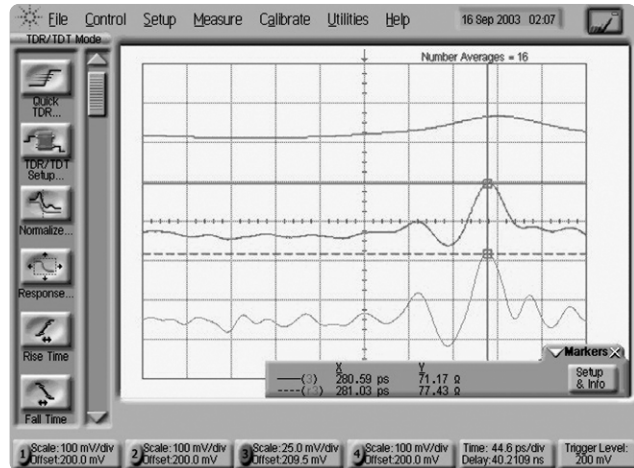

Figure 2: Reflections as a function of edge step-speed.

Signal integrity as well as failure analysis often requires the ability to locate and distinguish multiple, closely spaced reflection sites. A TDR can resolve two discontinuities if they are separated by roughly half the TDR rise time. Since typical TDR oscilloscope rise time is in the 35 ps range (both step generator and oscilloscope), that limits the measurable separation between two discontinuities to approximately 17 ps. In materials with a dielectric constant near 1, this corresponds to a physical separation of about 5 mm (See the section "Using very fast edgespeeds for accurate measurements of closely spaced reflections"). Typical printed circuit board material will have a dielectric constant of approximately 4. The measurable separation becomes about 2.5 mm (This value will be larger if the signal fields are in air as well as the board dielectric). Some small interconnects, such as board vias, package leads, and socket connections may be shorter than the physical distance computed above. Thus there is a need to increase the speed of the TDR step generator and the bandwidth of the oscilloscope so the combined system risetime is fast enough to resolve closely spaced reflections. Note also that lower quality cables and connectors (discussed below) can also slow down the effective system risetime and degrade the two-event resolution.

## Cables and connectors cause loss and reflection

Cables and connectors between the step source, the DUT, and the oscilloscope can significantly affect measurement results. Impedance mismatches and imperfect connectors add reflections to the actual signal being measured. These can distort the signal and make it difficult to determine which reflections are from the DUT and which are from other sources.

In addition, cables are imperfect conductors that become less ideal as frequency increases. Cable losses, which increase at higher frequencies, increase the risetime of edges and cause the edges to droop as they approach their final value. Thus the issues surrounding the performance of the step generator discussed above are now present due to the cabling and can turn a very good step generator into an apparently bad one. Figure 3 illustrates how cables and connectors affect TDR/TDT measurements. The fastest waveform is the reflection of a step from a short circuit connected directly to the TDR. (Recall that the returned signal from a short circuit inverts the step generator output and that the signal must travel out and back through any cabling). The second fastest step is for a short circuit connected through 1 meter of high-quality cabling. The third is of a short circuit through 0.6 meters of inexpensive cable and SMA connectors. The important point here is that cabling can reduce the precision of a TDR measurement system.

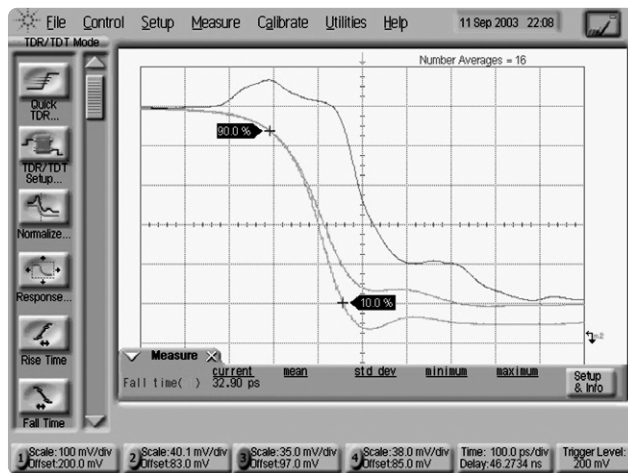

Figure 3: How cabling and connectors can degrade the TDR system.

## Techniques to minimize the effects of fixturing

The TDR has 3.5 mm coaxial cable output/input ports. When the DUT similarly has 3.5 mm or SMA ports, connecting it to the TDR system is straightforward. As discussed above, if adapters, probes, or non-coaxial cables are required to reach the DUT, measurement results can become degraded through spurious reflections and systematic losses. Because these error mechanisms are stationary and systematic, there is an opportunity to use calibration techniques to significantly enhance measurement accuracy and minimize these error-producing effects.

One technique to remove systematic measurement errors is waveform subtraction. In this technique, an ideal DUT is connected to the system and the TDR waveform is recorded. When subsequent DUTs are tested, the recorded trace is subtracted from the current trace. Any differences indicate the deviation of the DUT from the ideal. Systematic errors are common to both traces and are effectively removed. This is a simple and convenient accuracy enhancement technique, but there are some significant limitations. First is the requirement of an ideal reference DUT. This may simply not exist or may be very difficult to achieve. Second, all results are relative. There is no simple way to see the absolute performance of the DUT. Finally, the step signal arriving at the DUT may become degraded. Even if this effect is common to both the reference and DUT measurement, it can severely limit the TDR performance.

Another calibration technique is built on the principle of characterizing the test system with precision standards or “known” devices. But rather than produce a reference trace for waveform subtraction, this technique is capable of altogether removing the systematic test system response from the DUT response. The process is commonly referred to as TDR normalization and is an easy and yet elegant and extremely powerful technique to achieve precision results with a TDR.

As powerful as the calibration technique is, the procedure to implement it is very simple and achieved in just a few basic steps. Calibration measurements, which characterize the test system, are made with all cables and connections in place but without the DUT. The first part of the calibration removes systematic errors due to trigger coupling, channel crosstalk, and reflections from cables and connectors by measuring the response with the DUT replaced by a short circuit. From this measurement the test system frequency response is derived. A short circuit is specifically used rather than an open circuit. It is straightforward to produce a true short circuit, while an open circuit often will have some of the energy lost due to radiation rather than returned through reflection. The lost energy would corrupt the calibration results. Therefore, it is important that a good quality short be used, because the calibration process assumes a perfect short circuit

termination. Any non-ideal components in the measured short are attributed to the test system. If any of the non-ideal components are, in reality, due to the short itself, the calibration will attempt to correct for error terms that do not exist in the test system. By attempting to correct for errors that do not exist, the calibration can actually add error terms into the normalized measurement results.

### Generating the Digital Filter

The second part of the calibration generates a digital filter. This is done automatically without any input from the user. The digital filter compensates the variation of the frequency response of the test system from the ideal. If the calibration signal was passed through the filter, the result would be the ideal response. The filter removes errors by attenuating or amplifying and phase-shifting components of the frequency response as necessary. Consider, for example, overshoot on the step stimulus. Without calibration, the frequency response of the DUT will include unwanted response to the overshoot. During normalization, the filter will phase-shift and attenuate the frequencies responsible for the overshoot and thus correct the DUT response to the overshoot. The filter works similarly to correct for cable losses due to attenuation of high frequencies. It compensates for cable losses by boosting high-frequency components in the DUT response back up to their proper levels.

Unlike the errors removed by subtracting the first calibration signal, the errors removed by the filter are proportional to the amplitude of the DUT response. For TDR, this is done by replacing the DUT with a termination having an impedance equal to the characteristic impedance of the transmission line, typically 50 Ohms. If the termination is properly matched, all of the energy that reaches it will be absorbed. The only reflections measured result from discontinuities along the transmission line. In both cases, the measured waveforms are stored and subtracted directly from the measured DUT response before the response is filtered. Ideally, these calibration waveforms are flat lines. Any nonflatness or ringing is superimposed on the measured DUT response and represents a potential measurement error source. These errors are not related to the magnitude of the response of the DUT. Therefore, it is valid to remove these error mechanisms by subtracting them directly.

The digital filter effectively defines an ideal impulse response. A good basis for a normalization filter is a four-term, frequency-domain sum of cosines window, with the appropriate coefficients. A window of this form may be selected that rolls off quickly and has an almost Gaussian impulse response. The impulse response of the window defines the ideal response. The Gaussian response is considered ideal because it has a no overshoot after a transition from one voltage level to

another. Minimizing the settling time minimizes the interference between closely-spaced discontinuities, thus making them easier to see and analyze. The filter's bandwidth, and therefore risetime, is determined by the choice of  $L$ , the width of the sum of the cosines window. The actual normalization filter,  $F(f)$ , is computed by dividing the sum of cosines window by the frequency response of the test system,  $S(f)$ . Frequency response is the Fourier transform of the impulse response. By varying

the bandwidth of the filter, normalization can predict how the DUT would respond to ideal steps of various risetimes. The bandwidth of the test system is the frequency at which the frequency response is attenuated by 3 dB. The response beyond the cutoff frequency is not zero; it is only attenuated. By carefully changing the -3 dB point in the frequency response, the bandwidth can be increased or decreased.

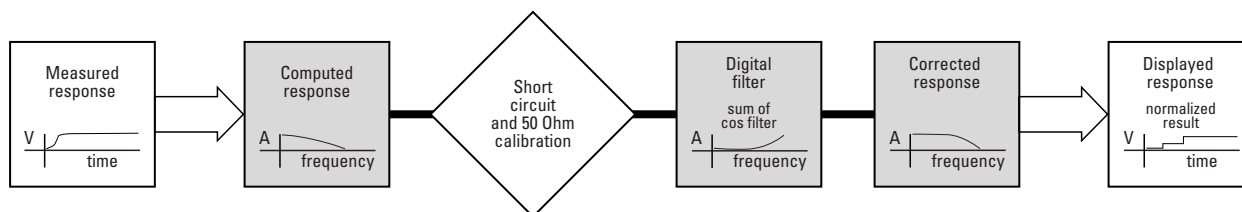

The digital filter generated through the normalization calibration also adds the capability of adjusting the effective risetime of the TDR step generator. Thus the 35 ps step of the Agilent 54754 plug-in module can be slowed down or sped up to simulate fast or slow electrical signals. In the Agilent 86100, the user-specified risetime determines the bandwidth of the filter. Decreasing the bandwidth is accomplished by attenuating the frequencies that are beyond the bandwidth of interest. Increasing the bandwidth requires more consideration. To increase the bandwidth, the response beyond the initial -3 dB frequency needs to be amplified. While this is a valid step, it is important to realize that the system noise at these frequencies and at nearby higher frequencies is also amplified. The limit to which the risetime of real systems may be extended, is determined by the noise floor. In real systems, there is a point beyond which the amplitude of the frequency response data is below the noise floor. Any further increase in bandwidth only adds noise leading to a coarse measurement result. Because waveform averaging reduces the initial level of the noise floor, waveform averaging should be used when using the normalization calibration, particularly when decreasing the step generator risetime.

**Measurement examples:**

In the following measurement example, the simple PC board transmission line used in the example of Figure 4 (with both a high and low section of transmission line impedance) is measured. However, a duplicate section of transmission line is placed in series with the first. Ideally the measurement of the second section of line should be a duplicate of the first. However, the reflections and attenuation of the first section significantly degrade the measurement of the second, as shown below.

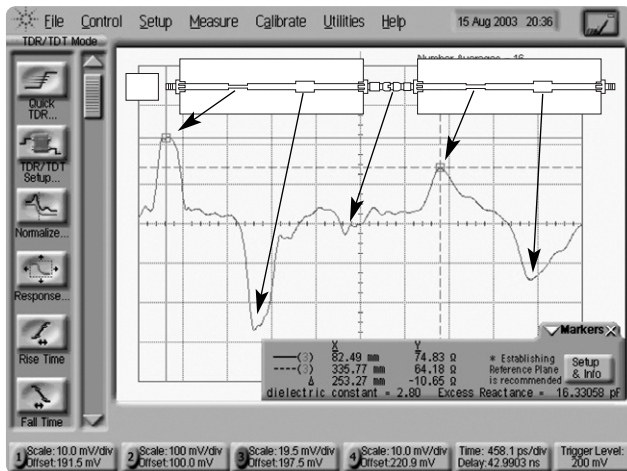

**Figure 4: TDR measurement of two multiple impedance transmission lines in series.**

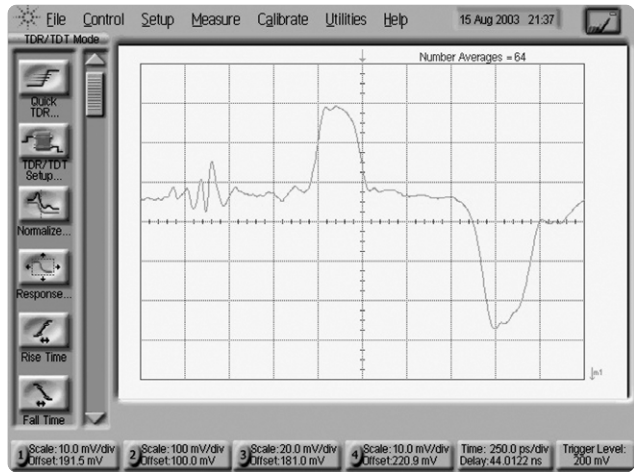

**Figure 5: View of the first PC board.**

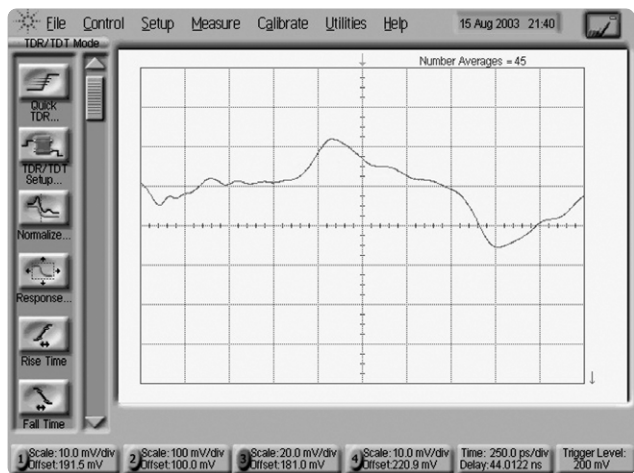

**Figure 6: View of the second PC board.**

The above two figures show first the measurement of the first section of line, while the second figure shows the measurement of the second section of transmission line. Note how the second section, although identical to the first, has measurement results that are significantly attenuated and smeared compared to the first. This then shows how the cabling and fixturing leading up to a DUT can significantly alter the TDR results.

Calibration can significantly improve the measurement results. Breaking the connection between the two transmission line sections, a short and load termination can be placed at the output of the first section of line. This then becomes the measurement reference plane. The calibration procedure will then correct measurement errors generated before this point.

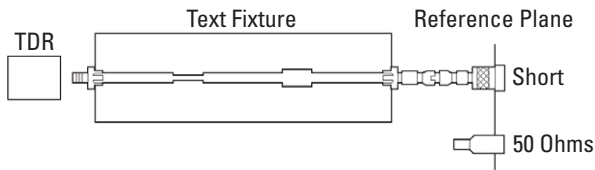

**Figure 7: Setup for the normalization calibration.**

With the calibration complete, the measurement results for the second board are seen. Note that the effects of the first board are removed in two ways. First, the reflections of the first transmission line are effectively removed from the result. Second, the effects of the first transmission line upon the measurement of the second line are also removed. The measurement results of the second line now are in excellent agreement with the direct measurement of the line seen in Figure 1.

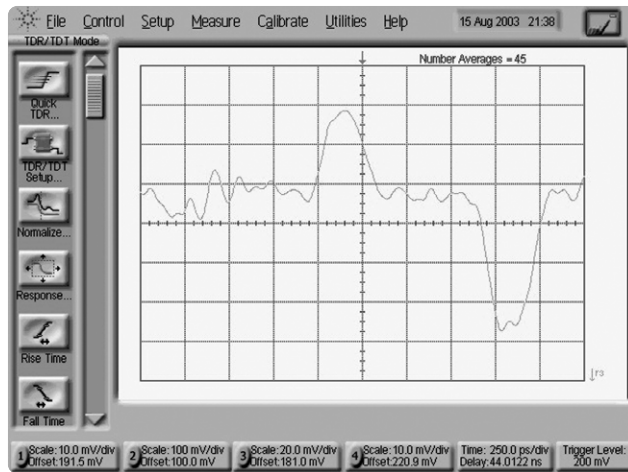

**Figure 8: Calibration removes the effects of the test fixture.**

The normalization calibration provides significant improvement in the measurement of components where the DUT is not a coaxial component. Examples include probing on circuits and non-coaxial cabling systems (such as Infiniband and 10 Gbit Ethernet CX4). Using a TDR requires some form of fixturing to go from the coaxial system of the TDR to the non-coaxial DUT. The adapters and fixtures to allow this will mask the true performance of the non-coaxial DUT. However, the problem is significantly reduced through calibration. This is achieved when a short and load termination can be measured in the native environment of the DUT. For example, probing calibration standards are used to remove the effects of a probing system. A short and load in an Infiniband cable can remove the effects of the adapters needed to go from the coaxial TDR to the Infiniband environment.

A second benefit of the calibration is the ability to effectively speed up or slow down the edgespeed of the TDR step. This was discussed above on page 4 where it was shown that the TDR edgespeed should be similar to the edgespeeds components will encounter in actual usage. The TDR results then are directly applicable to how the component will be used.

The normalization calibration then provides a convenient method to examine the impedance performance of components for a variety of signaling rates. For further details on the basis and construction of the normalization calibration, please refer to Agilent Application Note 1304-5 "Improving TDR/TDT Measurements Using Normalization".

In summary, the key benefits of this calibration process are:

- Removal of reflections within the test system and connections to the DUT
- Removal of imperfections (overshoot and ringing) in the step generator pulse
- Control of the step generator edgespeed
- Compensation for loss/attenuation in test system cabling



## Using very fast edgespeeds for accurate measurements of closely spaced reflections

In TDR measurements, as the physical separation between reflection sites diminishes, eventually the two reflections appear as one. The limitation in the TDR system to see closely spaced reflections is fundamentally tied to the risetime of the step generator and the bandwidth of the oscilloscope. As discussed earlier, a general rule is that reflections must be separated in time by at least half the TDR system risetime to be resolved as two distinct reflections. To get an intuitive feel for this consider a basic microstrip transmission line where the impedance changes from 50 Ohms to 60 Ohms and then back to 50 Ohms. Since there are two locations on the line where the impedance changes, there will be two reflection sites. How narrow can the 60 Ohm section be before the two impedance transitions can no longer be observed individually? The TDR trace will be at the 50 Ohm level until the transition to 60 Ohms is encountered. Since the impedance becomes higher, the reflected voltage will be in phase and add to the 50 Ohm level. The time required to reach the full 60 Ohm voltage level is simply the risetime of the step generator. The TDR response will stay at the 60 Ohm level until the transition to 50 Ohms occurs. The time required to make the full transition back to the 50 Ohm level (after the transition is initially encountered) is once again the risetime of the TDR system.

As the section of 60 Ohm line gets shorter, the transition from 50 Ohms to 60 Ohms will become close to the transition from 60 to 50. When the beginning of the voltage transition for the 60 to 50 Ohm section is at approximately the same time as the end of the voltage transition for the 50 to 60 Ohm section, the minimum measurable spacing for two reflection sites has been achieved. If the reflection sites become closer, the TDR waveform will not have sufficient time to reach full amplitude and the measurement of the magnitude of the impedances will be in error.

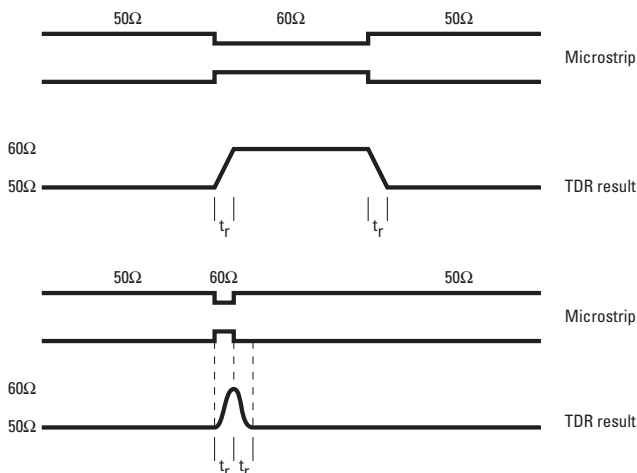

Figure 9: Determining two-event resolution.

Thus on the TDR display, the “time” between the two reflection sites can be noted as the time difference between the foot of the first edge (due to the 50 to 60 Ohm transition) and the foot of the second edge (due to the 60 to 50 Ohm transition, and in this case a falling edge). This time is essentially the risetime of the TDR system. However, it is important to note that the time displayed on the TDR is indicative of roundtrip reflections or in other words how long it takes for the pulse to get to and return from reflection sites. Thus the time separation noted above is the roundtrip time. The minimum one-way distance between reflection sites is then half of the system risetime. The minimum physical distance is given by the propagation velocity in the media and TDR system risetime:

$$\text{Equation 2: } \frac{c \cdot t_{\text{rise}}}{2\sqrt{\epsilon}}$$

where epsilon is the dielectric constant of the transmission system and c is the speed of light in a vacuum.

The effective system bandwidth and step speed can be increased through the normalization calibration as discussed above. Thus the two-event resolution of the TDR system is improved through normalization. The fastest step that can be achieved with normalization alone is in the 15 to 20 picosecond range. Some of the limitations have to do with the reduction in system signal-to-noise. That is, as the calibration filter can be used to compensate for the system rolloff, it will also effectively amplify the system noise, which may require trace averaging to produce the best results. Where signal processing becomes limited in its usefulness, the measurement hardware can be improved to yield higher two-event resolution.

To increase the two-event resolution of the TDR system, three items are considered:

- Increase the speed of the step generator
- Increase the bandwidth of the oscilloscope
- Minimize the bandwidth limiting effects of any test system cabling and fixturing

The step speed of the 54754 TDR plug-in module can be significantly increased using the Picosecond Pulse Labs model 4020 source enhancement module. This TDR accessory will receive the ~35 picosecond step from the 54754 and put out a pulse with a risetime less than 9 picoseconds. The 86118A plug-in module can be used to solve both the oscilloscope bandwidth and cabling/fixturing problem. The bandwidth of the receiver channel within the 54754 plug-in module is approximately 18 GHz, while the bandwidth of the 86118 exceeds 70 GHz. This module has its sampling electronics in a small housing that can be physically placed at the DUT with virtually no cabling. With these three key changes to the TDR system, the overall

system risetime can be under 9 picoseconds yielding a two-event resolution better than 1.5 millimeters for dielectric constants of 1 (vacuum) and 0.7 millimeters for dielectrics of 4. (Keep in mind that for microstrip, the effective dielectric constant is generally smaller than the board material dielectric, as the electric fields are in both air and the substrate).

In addition to being able to distinctly identify and locate closely spaced reflection sites, the increased system speed yields more accurate impedance assessments. When two events are spaced closely together, the impedance measurements (dependent upon signal amplitude) will be in error if the system is not fast enough to allow reflected steps to reach the full amplitude before another reflection is encountered.

The Picosecond Pulse Labs 4020 module will amplify the 200 mV step from the Agilent 54754A step generator to approximately 4 V. This signal is then sent to the 4020 microcircuit which consists of a non-linear transmission line and signal pick-off. The non-linear transmission line speeds up the input pulse to approximately 5 ps at 200 mV. This signal is sent to the DUT. Any reflections from the DUT return to the 4020 microcircuit and are routed through an internal pickoff to the 86118 plug-in, which is mounted directly to the 4020.

One of the advantages of generating a real 5 ps edge is that the normalization process will be using high frequency energy that is further from the instrument noise floor, requiring less averaging and a more stable measurement result. The receiver bandwidth needs to be wider to maintain this edgespeed, which in turn increases the system noise, but the overall noise floor of the system will usually be better when the fast edge is generated in hardware.

The procedure for using the Agilent 86100/54754/86118A system with the Picosecond Pulse Labs 4020 is straightforward. The 86100/54754 is configured as follows:

One of the outputs of the 54754 TDR plug-in module is connected to the 4020 amplifier section. The amplifier section is connected to the 4020 microcircuit. The output of the 4020 is connected to the DUT. The 86118 is mounted directly to the other output of the 4020.

(To configure the TDR/TDT measurement, in the TDR setup menu the source is selected as “External” and the destination is selected to be the electrical channel of the 86100 that is connected to the output of the 4020 microcircuit. Picosecond Pulse Labs also produces a 4022 module, which will produce both a positive step and a negative step in the 5 picosecond range for use with differential circuits.)

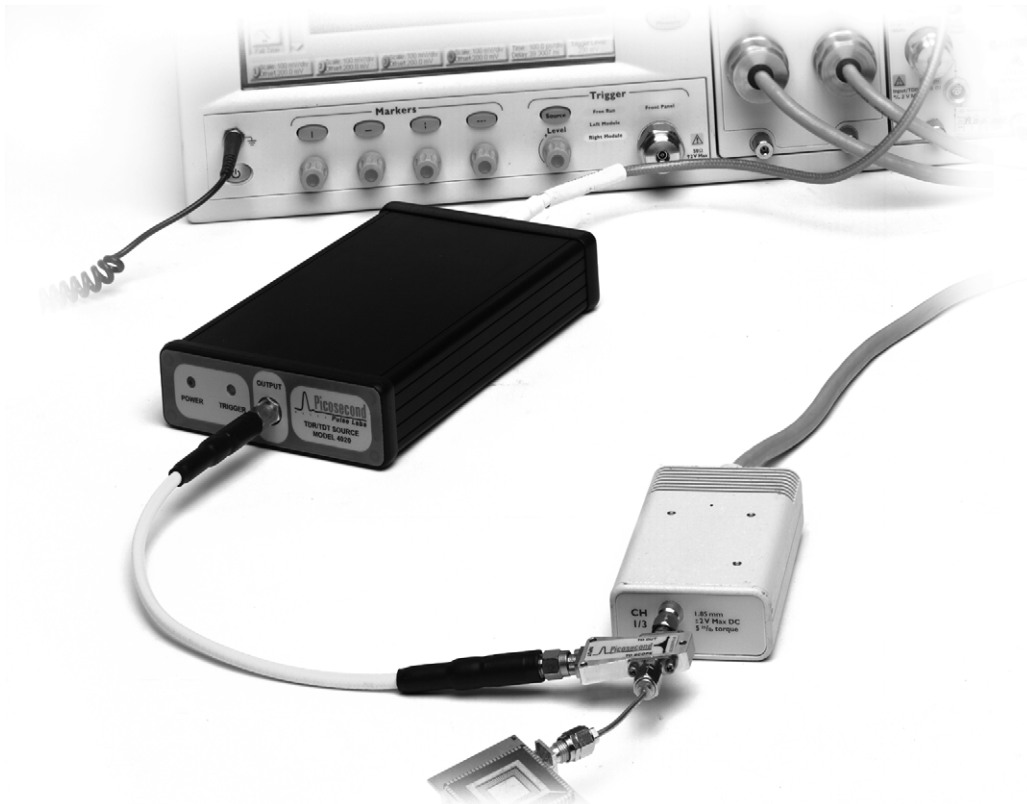

Figure 10: Picosecond Pulse Labs 4020 amplifier, microcircuit and 86118A sampler head.

The benefits of the increased edgespeed are first observed in Figure 11. In one trace, the nominal 35 picosecond edgespeed of the TDR is used. The maximum impedance observed is about 51 Ohms. When a 9 ps edge is used, the maximum impedance is 58 Ohms. Two important points need to be made. First, the amount of signal reflection is dependent upon the speed of the signal presented to the DUT, either by the TDR or in actual usage. The second is that the ability of the TDR to accurately quantify the reflection magnitude is dependent upon the edgespeed. But it is important to note that the amount of reflection that a component will generate is not necessarily best determined by the fastest edgespeed possible. For the DUT in Figure 11, if it is used in a system where the signals have edgespeeds in the 35 picosecond range, the reflections will likely be small. However, if the signals have edgespeeds in the 10 picosecond range, the reflections will be significantly larger. Thus the edgespeed of the TDR system should be close to that of the signals the DUT will encounter in actual usage for an accurate assessment of signal reflection magnitude in that system.

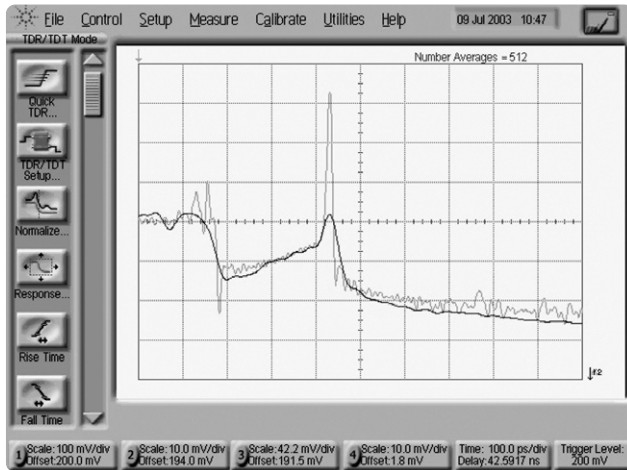

Figure 11: Microcircuit measured with a 35 ps TDR and a 9 ps TDR.

However, when it comes to resolving closely spaced reflections, it is important to have the fastest edgespeed possible. Consider the connector system measured in Figure 12 below.

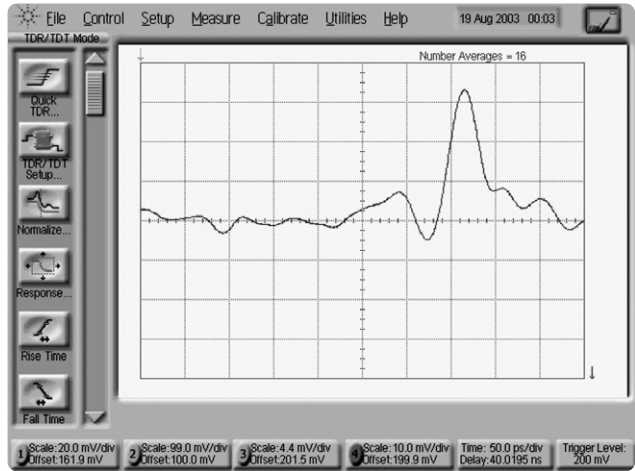

Figure 12: Connector assembly measured with 35 ps TDR.

It is easy to see that there are multiple reflection sites in the DUT, as the trace makes several upward and downward transitions. Towards the right side of the trace it appears that there may be some reflection sites that have blended together. This measurement was made with a 35 picosecond step speed. The TDR response looks significantly different when the step speed is increased to 11 ps and the TDR receiver has a 75 GHz BW, as seen in Figure 13.

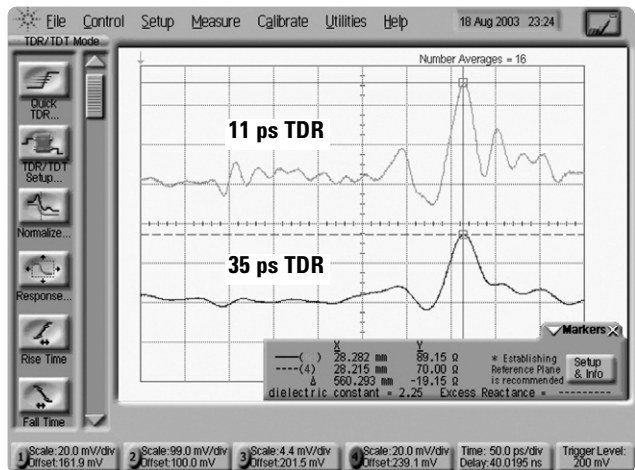

Figure 13: Connector assembly measured with an 11 ps and 35 ps TDR.

Figure 13 shows both the 35 picosecond (lower trace) and the 11 picosecond (upper trace) results. Important differences include the clear resolution of several discontinuities as well as a much more accurate assessment of the impedance levels of the discontinuities. Note that the large reflection site is measured at almost 90 Ohms at 11 picoseconds, but only 70 Ohms at 35 picoseconds.

Considering two-event resolution, the two closely spaced events are easily resolved. In this case, the largest transition from high to low impedance is separated from the next transition (from low to high) by only 2 mm and are still easily and accurately resolved as individual reflections (Figure 14).

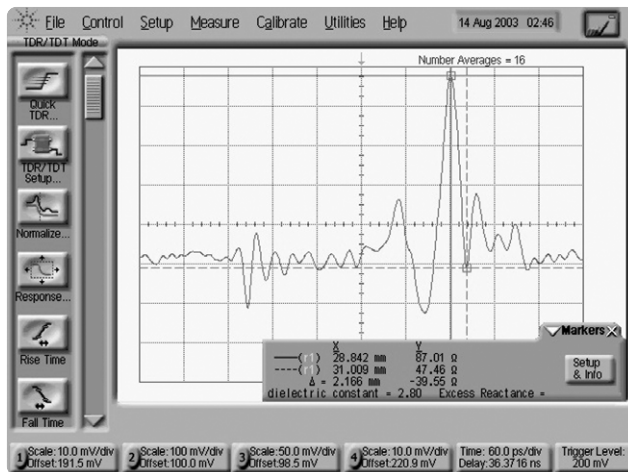

Figure 14: Increased two-event resolution with a faster TDR.

## Performing precision TDR measurements for differential transmission systems

As systems increase in speed, differential transmission techniques are used to maintain signal integrity. Differential transmission uses two transmission lines carrying complementary data signals. Characterizing the quality of a differential transmission line for impedance values and discontinuities requires a technique to stimulate both legs of the transmission media. Also, when the two transmission lines are electromagnetically coupled with each other, analysis of the impedance properties of the system requires some modification compared to a single-ended line.

The most obvious technique for testing a differential transmission line or component is to have a TDR system with complementary step generators. That is, while one step generator produces a positive going step into the “positive” side of the system, a second step generator produces a negative going step into the “negative” side of the system. Differential impedance measurements are made by comparing the reflected differential voltage with the incident differential voltage. (Differential voltage being defined as the voltage across the two input terminals of the DUT and differential impedance being the differential voltage divided by the current through the system. Note that if the system is balanced, the current into one side of the line is the same as the current out of the other side).

Precision differential TDR measurements place some critical restrictions on the TDR system. Any asymmetries in the two legs of the measurement system may potentially lead to imbalances or errors in resulting measurements. Asymmetry in a differential system is one of the leading causes of mode conversion from differential to common mode or vice versa. Error sources include:

- Timing skew between the two step generators
- Timing skew between the two oscilloscope receivers
- Differences in the step pulses in the two generators, either in amplitude or in overall shape
- Differences in the response of the two oscilloscope receivers

Combining carefully designed hardware and a novel approach to analysis of the received signals provide the foundation for an accurate measurement solution. In addition, the normalization process discussed earlier, with all of its capabilities to remove systematic error producing effects, has been extended for use with differential TDR. The end result is the highest precision in differential TDR measurements.

The 86100 TDR system has skew capability at both the step generators and receiver. It is important to understand how each is implemented and what the effects will be on the measurement results. When examining a differential transmission system, it is critical to maintain a precise alignment of the stimulus pulses. The time at which the first step generator produces a pulse can be adjusted to occur either later or earlier than the pulse from the other step generator of the 54754 plug-in module. Either step generator can be advanced or retarded approximately 180 picoseconds. This allows the relative position of one step to be shifted up to ~360 picoseconds from the other step.

The receiver of the TDR can also be adjusted to sample data at a variable time relative to the step generator trigger event (which is used to determine when the signals are sampled). Thus the signal returning to one channel of the differential TDR can be effectively shifted in time relative to the other channel by adjusting the time at which it is acquired by the TDR. This then effectively allows the returned signals to be aligned if any system skew must be eliminated.

For example, if there are unequal lengths of cable between the two step generators and the DUT, the two steps would arrive at different times at the plane of the DUT. Also, the reflected signals from the DUT would be misaligned as they return to the TDR receiver through the unequal lengths of cable. A procedure is built into the 86100 TDR system to remove the effects of skew due to path length leading to the DUT. One part ensures that the steps are aligned at the reference plane (to balance the stimulus to the DUT) while the other part removes the misalignment of returning signals to the TDR.

Another critical issue for differential measurements is the overall characteristics of the TDR stimulus pulses. To produce a symmetric differential stimulus, one approach would be to carefully design the negative step generator to produce a pulse of identical shape but opposite polarity of the positive step generator. While it is a reasonable task to do this and maintain similar pulse magnitudes, it is very difficult to achieve the identical pulse shape and edgewise required for a precision TDR. A practical yet elegant approach to this problem takes advantage of the fact that TDR is valid only on linear passive components (includes 'active' components measured while operating in a linear passive state). This can significantly simplify the problem leading to a very accurate measurement solution.

One of the fundamental techniques used for general circuit analysis when multiple energy sources are present is the use of the superposition theorem. Superposition allows circuit performance to be determined by analyzing results with a single energy source active while all others are inactive, and then combining the results to determine the overall response when all sources are active. Most engineers are familiar with this principle and its applicability to common circuits composed of wires, resistors, and batteries. The superposition theorem is completely valid for a circuit involving transmission lines, even when there may be electromagnetic coupling taking place, and is used to analyze many complex microwave structures. Again, the only restriction is that the system being analyzed is linear.

Taking advantage of the superposition principle, a differential circuit can be accurately measured by first stimulating one leg of the system, then stimulating the other leg, and finally combining the results to determine the aggregate response. Further taking advantage of this principle, the negative going step need no longer be negative. The negative leg of the system can be driven with a positive pulse, since the linear system will produce identical results, but with a reversed polarity. Before combining the results for each leg, the results from the negative leg driven by a positive pulse are simply inverted.

The technique of using two positive pulses to produce a differential TDR system thus solves one of the key sources of measurement uncertainty. Even though the two legs of the differential circuit are driven by two separate step generators, the characteristics of the pulses are virtually identical in terms of amplitude and pulse shape. Thus measurement error due to pulse asymmetries has been virtually eliminated.

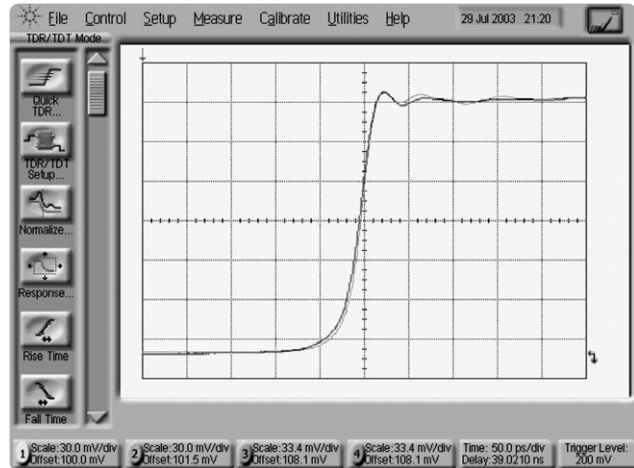

Figure 15: Dual outputs of the 54754 TDR.

Figure 15 shows the two pulses from the two step generators of the TDR overlaid. The pulses are virtually identical.

It is important to recognize the differences between a differential measurement and simply taking the difference between two single-ended measurements. The basic single ended measurement stimulates the input and examines what returns at that input port. The differential measurement stimulates *both* ports and examines what returns to *both* ports. The critical difference is that through coupling of the differential transmission lines, the stimulus on one port may result in signals being reflected back to both ports. Also, the characteristic impedance of the transmission line will be affected by a differential stimulus and the associated coupling. Again, the theory of superposition remains valid. Coupling effects for transmission lines are linear in nature. Precision measurement results are achieved through the combination of individual measurements on each leg of the differential channel.

An example of a single ended measurement of a differential transmission line is shown below. The two lines of this basic differential circuit initially have a single ended impedance of 50 Ohms. The lines are physically separate, thus there is minimal coupling in this region. The two lines then come together and the two trace widths are reduced (which would cause an increased single ended impedance). The lines are then increased in width and are spread apart.



Figure 16. Differential line model.

If each leg is tested individually (driven single ended), the TDR results are seen as a 50 Ohm line, then a 70 Ohm section, and a 50 Ohm section before being terminated in a 50 Ohm load. The result is the same for each leg.

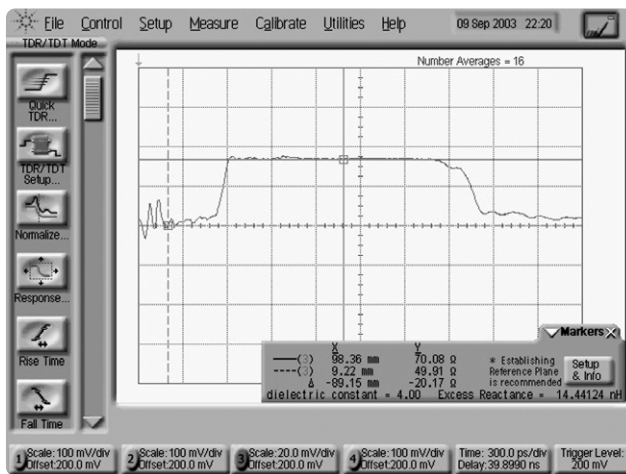

Figure 17. Differential trace measured single-ended

In the differential measurement, the TDR system combines the results from both ports when stimulated by both steps. Thus the signal on each leg will be a combination of signal from both step generators. The result is that the differential impedance is close to 100 Ohms, which was the intent of the transmission line design. The odd-mode impedance (one leg of the transmission line to ground when driven differentially) is close to 50 Ohms. The result is identical to what would have been achieved with simultaneous stimulation of the DUT, the only exceptions being if there were any asymmetry in the two pulses (in both timing or pulse shape), the imbalance would be transferred to the TDR result as measurement error. See Figure 18.

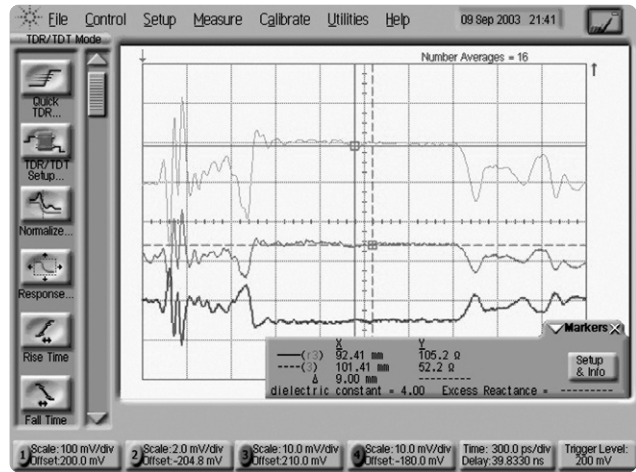

Figure 18: Differential TDR showing differential (upper trace) and odd-mode impedances (middle and lower traces) of the differential transmission line

The final steps to measurement error reduction involve de-embedding of fixturing and removing any residual aberrations in the pulses from the step generators. This is achieved with the calibration process referred to earlier as normalization (see pages 5-8). The procedure for differential measurements is similar to that used for single ended TDR, except that the procedure is performed twice (once for each channel). Normalization also allows for pulse risetime adjustments to simulate faster or slower data signals.

The benefits of the differential normalization calibration are shown in the example below where imperfect fixturing and cabling obscure the true results from the DUT. The first step is to remove any skew in the system prior to the DUT. First, the reflected signal from the DUT measurement plane (open circuit or short circuited) is examined (Figure 19). Half of the skew is removed through shifting forward the output launch time of the “late” step generator. The remaining half is removed by delaying the time at which the late signal is measured, effectively allowing it to catch up to the early signal. Note again that these corrections are made not for skew in the DUT, but in the system leading up to the DUT.

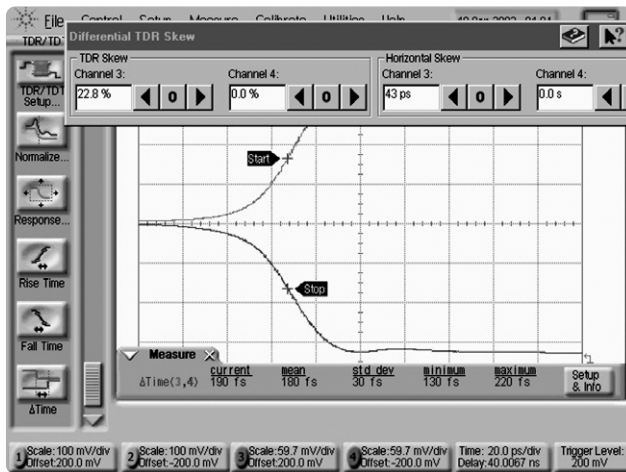
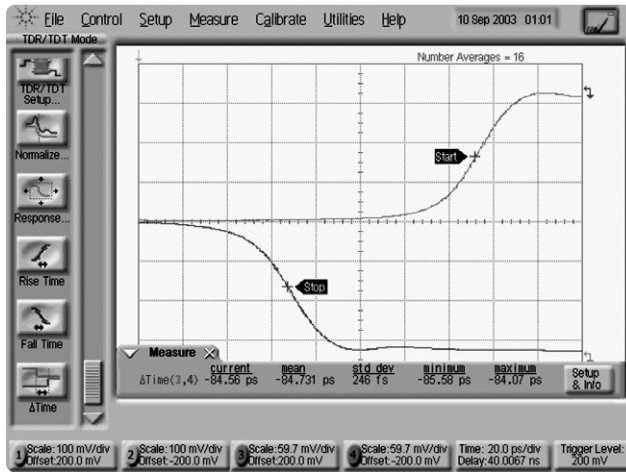

Figure 19: (before and after skew adjust).

Even with a precise alignment of the step generators and receivers, the fixturing leading to the DUT may degrade both the stimuli and DUT responses. As an example, this has been intentionally done through adding additional cabling and loss between the TDR and the DUT. The resultant measurement errors are shown in Figure 20. Compare the differential (upper) and odd-mode (middle and lower traces) results of Figure 20 to the same measurement (with no fixturing) of Figure 18. Rather than seeing a differential impedance of 105 Ohms, and odd mode impedance of 52 Ohms, the readings have increased to 109 and 54 Ohms.

When the measurement including the fixturing and loss is repeated, but the measurement errors removed by placing known reflection standards (loads and short circuits where the cabling connected to the DUT), the measurement results are in excellent agreement with those taken when no fixturing was physically in place (Figures 18 and 21).

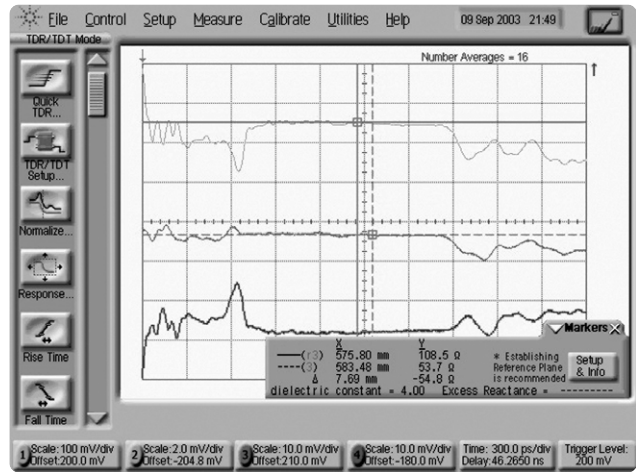

Figure 20: Differential and odd mode impedance results with fixturing error.

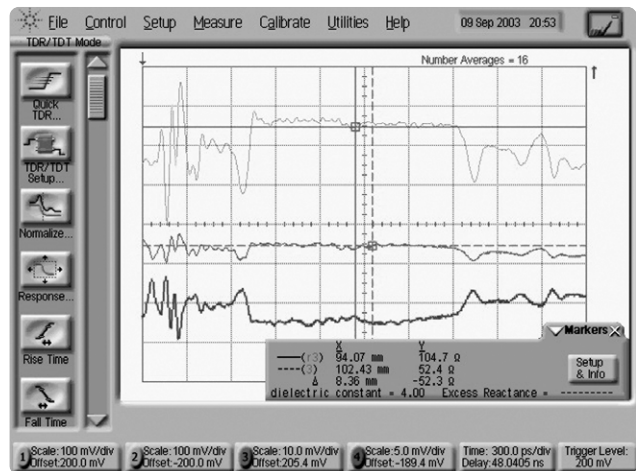

Figure 21: Differential and odd mode impedance results with fixturing errors removed.

The calibrated measurement system provides the highest precision differential TDR measurement result, even when error-producing mechanisms are present. The calibration process and measurement techniques are equally valid for common-mode measurements, where the two step generators have the same polarity outputs, based on calibration standards (load and short) being provided to perform the calibration. Measurements of DUTs that require a transition from the coaxial cabling of the TDR system to a non-coaxial cable type (such as Infiniband or 10 Gbit Ethernet CX4) benefit significantly from this, as long as a load and short termination is provided in the native cable type.

Further information on the basis for the superposition technique and its applicability to TDR measurements is found in Annex A of this document.

## Deriving 'S'- parameters from traditional TDR results

Important insights into component behavior can be achieved through frequency domain analysis in addition to characterization in the time domain. For example, a common measurement is to determine the amount of signal that is reflected back from a component over a specific range of frequencies, perhaps from the kilohertz range through the gigahertz range. The frequency response results often yield important insight into why components behave specific ways. Resonances are easily detected and general performance can be directly associated with specific circuit behavior. Advanced component models can be facilitated through frequency domain measurements. Such measurements are commonly called 'S' (scattering) parameters and have been used in RF and microwave design for decades.

The common instrument used to obtain S parameters is the network analyzer where a sinusoidal signal generator is varied in frequency over the range of interest. A receiver, tuned to the frequency of the signal generator is used to monitor the signal (reflected or transmitted) from the DUT. Components can be one-port (input or output only) or two-port (input and output). For the case of the two-port component, we are concerned with transmission and reflection at each port. Thus for a two-port component there are two pairs of reflection and transmission measurements and thus four S-parameters.

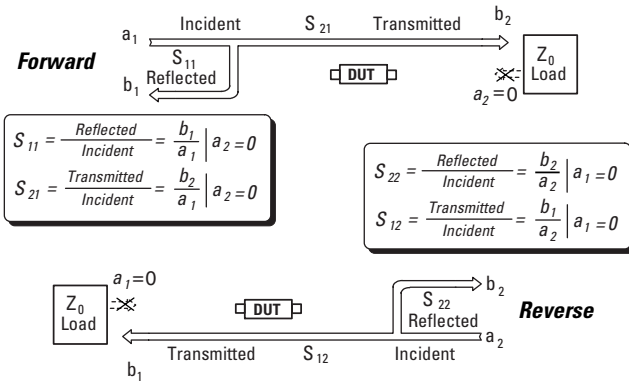

Figure 22: Signal model for S-parameters on a two-port device.

## Measuring differential components and channels

A differential component with just a positive and negative input and output adds two ports to the above example and four more S-parameters. However, differential channels can couple to their complementary channels, doubling the 8 S-parameters to 16. Note that the stimulus and response for these measurements are still effectively single-ended. That is, only one port is stimulated and one measured to construct each of the S-parameters. The S parameter notation is  $S_{out/in}$ . Thus  $S_{21}$  is the signal seen at port 2 with a stimulus at port 1. In the following example for a differential circuit, one differential port pair is noted by ports 1 and 3, the other differential port pair by ports 2 and 4. The 16 possible measurement configurations and some physical interpretations are shown below.

	Stimulus	Interpreting single-ended measurements:
<b>Response</b>	$S_{11}$ $S_{12}$ $S_{13}$ $S_{14}$	$S_{11}$ : return loss, single-ended
	$S_{21}$ $S_{22}$ $S_{23}$ $S_{24}$	$S_{21} = S_{12}$ : insertion loss, single-ended
	$S_{31}$ $S_{32}$ $S_{33}$ $S_{34}$	$S_{31} = S_{13}$ : near end cross talk
	$S_{41}$ $S_{42}$ $S_{43}$ $S_{44}$	$S_{41} = S_{14}$ : far end cross talk



Figure 23: Single-ended S-parameters for a 2 port differential device.



Finally, a differential circuit can be driven in either differential or common mode, and the response be measured in a differential or common mode. Thus the full S-parameter set for a two-port differential component, including single-ended, differential, common, and mixed mode configurations has 32 unique S-parameters.

It is important to interpret what the various differential and common mode measurement configurations provide. The differential S parameter notation is slightly different than the single ended notation. It still follows an S “out-in” format. However, port 1 includes both the positive and negative legs of the differential input, as also does port 2.

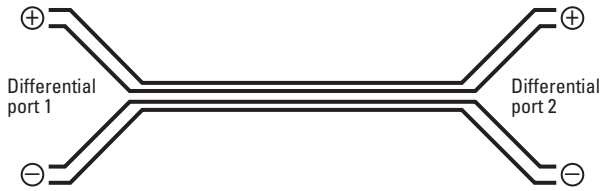

Figure 24: Differential S-parameter model.

Thus  $S_{DD11}$  indicates the reflected differential signal when stimulated differentially. Similarly,  $S_{DD21}$  indicates the differential output (at differential port 2) when a differential signal is input to differential port 1. Thus there are four basic quadrants to the 16 element differential S-parameter matrix, as displayed in Figure 25. The upper left quadrant is a measurement of differential transmission and reflection for a device with two differential ports (typically differential in and differential out) when stimulated with differential signals. Similarly, the lower right quadrant gives common transmission and reflection performance when the two port device is stimulated with common mode signals.

		Stimulus			
		Differential signal		Common signal	
Response	Differential signal	Port 1	Port 2	Port 1	Port 2
		Port 1	$S_{DD11}$	$S_{DD12}$	$S_{DC11}$
	Port 2	$S_{DD21}$	$S_{DD22}$	$S_{DC21}$	$S_{DC22}$
	Common signal	Port 1	$S_{CD11}$	$S_{CD12}$	$S_{CC11}$
Port 2	$S_{CD21}$	$S_{CD22}$	$S_{CC21}$	$S_{CC22}$	

Figure 25: Mixed mode S-parameters.

The mixed mode parameters (combinations of differential and common mode stimulus or response) provide important information about how conversion from one mode to the other may occur which in turn provides insight into how components and channels may radiate or be susceptible to radiated signals. For example, the lower left quadrant indicates how differential input signals are converted to common mode signals.  $S_{CD21}$  would be a measure of how a differential input to port 1 is observed as a common mode signal at port 2 (see Figure 26). Common mode signals are more likely to cause radiated emissions than a differential signal, hence the  $S_{CD}$  quadrant is useful in solving such problems. The upper right quadrant ( $S_{DC}$ ) indicates how common signals are converted to differential signals. Differential systems are intended to reduce susceptibility to spurious signals by rejecting anything that is common to both legs of the differential system. But if spurious common mode signals are converted to differential signals, they no longer are rejected. Hence the  $S_{DC}$  quadrant measurements are useful in solving problems of susceptibility to spurious signals. For example,  $S_{DC21}$  indicates how a signal that is common mode at port one is converted to a differential signal and observed at port 2.



Figure 26: Mixed mode S parameters:  $S_{CD21}$ .

Although the network analyzer is directly suited to generate the frequency domain S-parameters, the 86100 TDR can be configured to produce frequency-domain S parameter results in addition to conventional TDR measurements. Depending upon the instrument configuration, the full set or a subset of the 32 differential S-parameters can be achieved. Full and thorough characterization of a component is now possible in both the frequency and time domains with a single instrument.

The complete instrument configuration requires an 86100 mainframe and two 54754A differential TDR modules to stimulate and receive signals at the four ports of the DUT (see Figure 27).

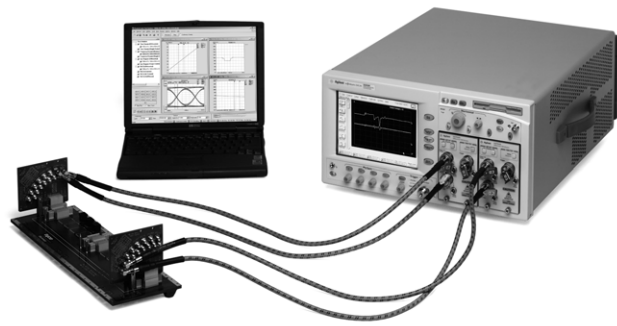

Figure 27: N1930A Physical Layer Test System with the 86100 TDR.

The 86100 TDR system does not provide the S-parameter measurement set directly. The N1930 Physical Layer Test System software (revision 2.0 or higher), controlling your TDR, provides the following functionality:

- Verifies the hardware configuration and determines the allowable measurement suite.
- Provides an easy to follow user interface for the step-by-step configuration and calibration procedure.
- Automatically removes source and fixture skew.
- Automatically performs the full measurement set (required to generate the S-parameter matrix).
- Converts the TDR measurement results into the equivalent S-parameter set.
- Produces a comprehensive report including the measurement results, instrument configuration, and calibration status.
- Creates the data files for importation into a variety of modeling programs. Modeling is then based upon accurate measurement results.

The power of the automation process should not be underestimated. The full measurement set can literally take a full day to perform manually, with the likelihood of making a small but critical setup error being very high. The automated process is performed in minutes and assures an accurate setup and measurement. Thus the value of the measurement software goes far beyond the ability to simply convert TDR results to S-parameters.

It is important to note that the ability to remove measurement errors due to fixturing and basic instrumentation imperfections through calibration (normalization) significantly enhances the precision of the S-parameter results.

The following shows the  $S_{DD21}$  measurement of a 34 cm length FR4 backplane trace. (This is the forward differential transmission frequency response measurement). Two traces are shown, both derived from original time-domain TDR measurements. The upper trace is from TDR data that employed the normalization calibration. The lower trace is from the TDR without calibration at the DUT reference plane. Thus the cabling leading to and from the circuit board is part of the measurement results.

Two important parameters are observed. The calibrated trace has a better frequency response (more bandwidth) than the uncalibrated trace. This makes intuitive sense, as the cabling leading to the DUT has some response rolloff, altering the measurement results. Also, the noise floor of the calibrated measurement is lower, indicating a more sensitive measurement. Without calibration beyond the TDR outputs, the S parameter information is somewhat pessimistic, which in turn leads to models with excess loss. Also, the phase information will have similar inaccuracies.

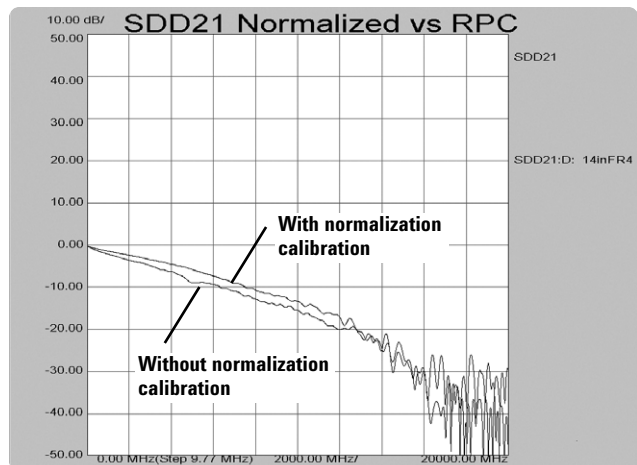

Figure 28:  $S_{DD21}$  results are improved through the normalization calibration.

## Annex A: Superposition for time-domain reflectometry

To fully characterize a differential transmission line, the TDR system should allow control of both the stimulus and the response. This allows differential response to differential-mode stimulus, differential response to common-mode stimulus, common-mode response to differential-mode stimulus, single-ended response to differential-mode stimulus and so on. Unbalanced differential lines and imperfect terminations can cause one mode to couple into the other leading to complex troubleshooting. The ability to efficiently examine the various signal configurations can yield the information needed to correct differential transmission problems.

The differential TDR can be represented by two pulse generators (A and B) and the two signals received on each line (A and B). Since the generalized differential line will have some coupling between the two channels, waveforms need to be acquired to see not only how generator A affects line A, but also how it affects line B. Likewise the effects of generator B on both line B and A are observed.

Let AA be the signal on line A caused by pulsing TDR A, AB the signal on line A caused by pulsing TDR B, BB the signal on line B caused by pulsing TDR B, and BA be the signal on line B caused by pulsing TDR A. Then for common-mode stimulus, the signal on line A or signal A, is AA + AB and signal on line B is BB + BA. For differential-mode stimulus, signal A is AA – AB and signal B is –(BB – BA).

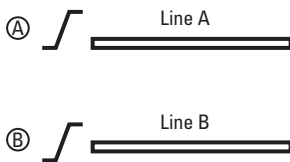

**Figure 29: TDR stimulus and response configuration**

The individual elements needed to construct the composite signal are produced by individually pulsing each TDR source and synchronously combining the results, as the timing is based upon a common trigger. Note how both the common-mode and differential-mode results are available from a single measurement setup. In mathematical terms, the ‘negative’ leg of the differential signal is produced by simply inverting the polarity of the B signal. Is it possible to achieve accurate differential TDR results if the DUT is not simultaneously stimulated by a positive and a negative step?

Intuitively, this is easily understood for a single-ended measurement. That is, we expect the TDR impedance or reflection coefficient results for a positive going step to be identical to those of the negative going step. Impedance being the ratio of voltage and current, reflection coefficient being the ratio of two voltages, identical results are achieved as there will be negative current for a negative voltage and positive current for positive voltages.

For differential measurements this is not intuitively obvious, as the effects of coupling involve electromagnetic fields, which surely depend upon the polarity of the voltages on the lines. Can valid results be obtained for both the common and differential-mode stimulus by simply inverting one channel in the instrument calculations? The technique is valid and perhaps is not as difficult to show as one might expect.

From the classic text on electromagnetics, *“Fields and Waves in Communications Electronics”* by Ramo, Whinnery, and Van Duzer, (1965, John Wiley and Sons) we read “It is frequently possible to divide a given field problem into two or more simpler problems, the solution of which can be combined to obtain the desired answer. The validity of this procedure is based on the linearity of the Laplace and Poisson equations. That is

$$\nabla^2(\Phi_1 + \Phi_2) = \nabla^2\Phi_1 + \nabla^2\Phi_2 \quad \text{Laplace}$$

and

$$\nabla^2(k\Phi_1) = k\nabla^2\Phi_1 \quad \text{Poisson}$$

The utility of the superposition concept depends on finding the simpler problems with boundary conditions which add to give the original boundary conditions”.

While most practicing electrical engineers have some familiarity with electromagnetic field equations, having not used them in day-to-day work relegates them to a level of mystery. However, a quick inspection of the equations does reveal the familiar test for linearity. That is the function of the sum of the elements is equal to the sum of the function of the two individual elements. Thus even electric field problems (measurements) can be solved by combining the results from individual measurements. The key requirement is linearity. Linearity is a basic requirement for TDR, as all results are extracted from simple measurements of the reflected voltage signal. Precision TDR measurements must assume passive, linear DUTs. Thus the superposition principle provides the basis for an effective and accurate method to perform differential TDR measurements.

## References:

William H. Hayt Jr.:  
*Electromagnetic Engineering*,  
Ch 4.5 "The potential field of a  
system of charges", McGraw-Hill

Ramo, Whinery, and Van Duzer:  
*Fields and Waves in  
Communication Electronics*,  
Ch 3.04 "Superposition", John  
Wiley and Sons

### Agilent Technologies' Test and Measurement Support, Services, and Assistance

Agilent Technologies aims to maximize the value you receive, while minimizing your risk and problems. We strive to ensure that you get the test and measurement capabilities you paid for and obtain the support you need. Our extensive support resources and services can help you choose the right Agilent products for your applications and apply them successfully. Every instrument and system we sell has a global warranty. Support is available for at least five years beyond the production life of the product. Two concepts underlie Agilent's overall support policy: "Our Promise" and "Your Advantage."

#### Our Promise

Our Promise means your Agilent test and measurement equipment will meet its advertised performance and functionality. When you are choosing new equipment, we will help you with product information, including realistic performance specifications and practical recommendations from experienced test engineers. When you use Agilent equipment, we can verify that it works properly, help with product operation, and provide basic measurement assistance for the use of specified capabilities, at no extra cost upon request. Many self-help tools are available.

#### Your Advantage

Your Advantage means that Agilent offers a wide range of additional expert test and measurement services, which you can purchase according to your unique technical and business needs. Solve problems efficiently and gain a competitive edge by contracting with us for calibration, extra-cost upgrades, out-of-warranty repairs, and onsite education and training, as well as design, system integration, project management, and other professional engineering services. Experienced Agilent engineers and technicians worldwide can help you maximize your productivity, optimize the return on investment of your Agilent instruments and systems, and obtain dependable measurement accuracy for the life of those products.

**By internet, phone, or fax, get assistance with all your test & measurement needs**

#### Phone or Fax

##### United States:

(tel) 800 452 4844

##### Canada:

(tel) 877 894 4414

(fax) 905 282 6495

##### China:

(tel) 800 810 0189

(fax) 800 820 2816

##### Europe:

(tel) (31 20) 547 2323

(fax) (31 20) 547 2390

##### Japan:

(tel) (81) 426 56 7832

(fax) (81) 426 56 7840

##### Korea:

(tel) (82 2) 2004 5004

(fax) (82 2) 2004 5115

##### Latin America:

(tel) (305) 269 7500

(fax) (305) 269 7599

##### Taiwan:

(tel) 0800 047 866

(fax) 0800 286 331

##### Other Asia Pacific Countries:

(tel) (65) 6375 8100

(fax) (65) 6836 0252

Email: [tm\\_asia@agilent.com](mailto:tm_asia@agilent.com)

##### Online Assistance:

**[www.agilent.com/comms/lightwave](http://www.agilent.com/comms/lightwave)**

Product specifications and descriptions in this document subject to change without notice.

© Agilent Technologies, Inc. 2003

Printed in USA, October 27, 2003

5988-9826EN



### Agilent Email Updates

**[www.agilent.com/find/emailupdates](http://www.agilent.com/find/emailupdates)**

Get the latest information on the products and applications you select.



**Agilent Technologies**