

## Errata

**Document Title:** Audio Frequency Measurements with the  
8556A-8552B Spectrum Analyzer (AN 134)

**Part Number:** 5952-1043

**Revision Date:** June 1971

---

### HP References in this Application Note

This application note may contain references to HP or Hewlett-Packard. Please note that Hewlett-Packard's former test and measurement, semiconductor products and chemical analysis businesses are now part of Agilent Technologies. We have made no changes to this application note copy. The HP XXXX referred to in this document is now the Agilent XXXX. For example, model number HP8648A is now model number Agilent 8648A.

### About this Application Note

We've added this application note to the Agilent website in an effort to help you support your product. This manual provides the best information we could find. It may be incomplete or contain dated information, and the scan quality may not be ideal. If we find a better copy in the future, we will add it to the Agilent website.

### Support for Your Product

Agilent no longer sells or supports this product. You will find any other available product information on the Agilent website:

[www.agilent.com](http://www.agilent.com)

Search for the model number of this product, and the resulting product page will guide you to any available information. Our service centers may be able to perform calibration if no repair parts are needed, but no other support from Agilent is available.

JUN 18 1971

Application Note 134

*Audio Frequency Measurements  
With The 8556A-8552B  
Spectrum Analyzer*

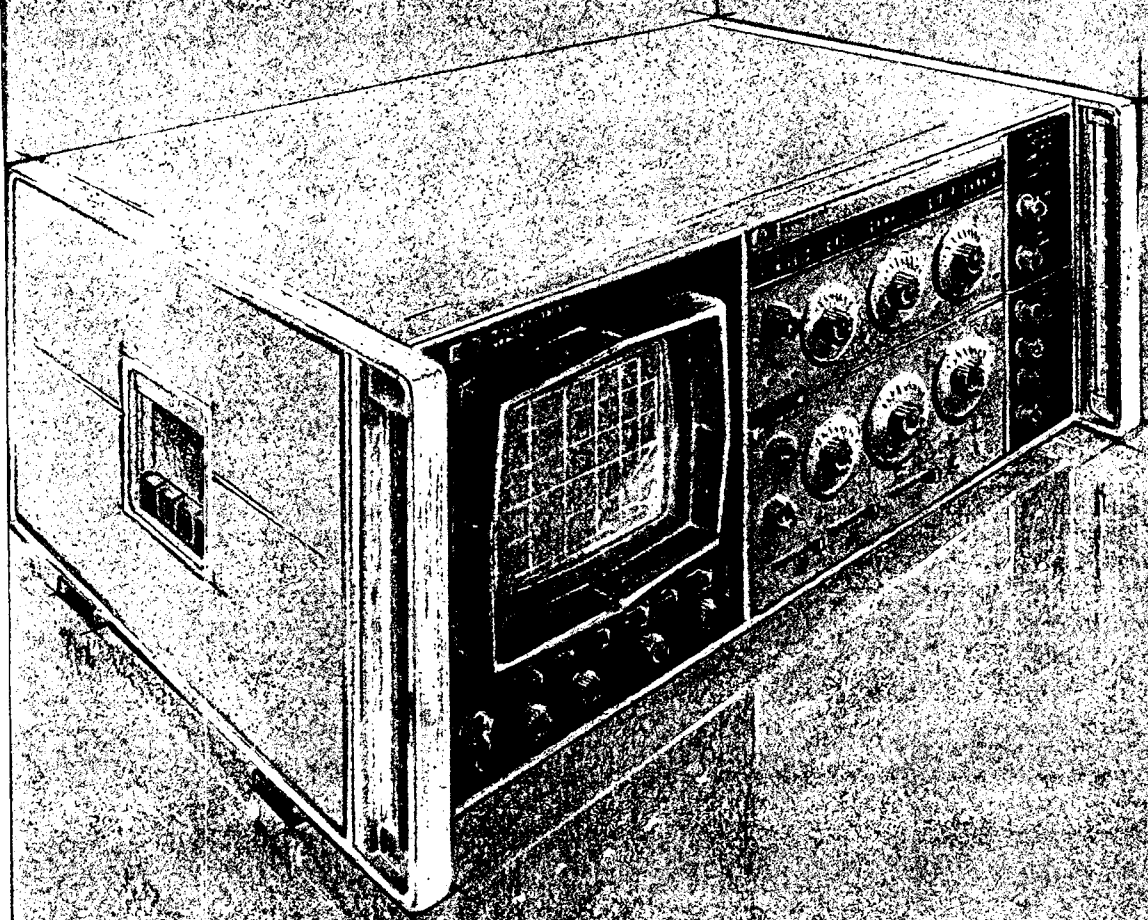

HEWLETT-PACKARD

## Contents

	<b>Page</b>
<b>Introduction</b> .....	<b>1</b>
<b>Features</b> .....	<b>2</b>
<b>Applications</b> .....	<b>3</b>
<b>Control Dictionary</b> .....	<b>4</b>
<b>Front Panel Adjustment Procedure</b> .....	<b>6</b>
<b>Operation</b> .....	<b>8</b>
<b>Compatibility</b> .....	<b>13</b>
<b>Theory of Operation</b> .....	<b>14</b>

May 1971

## Introduction

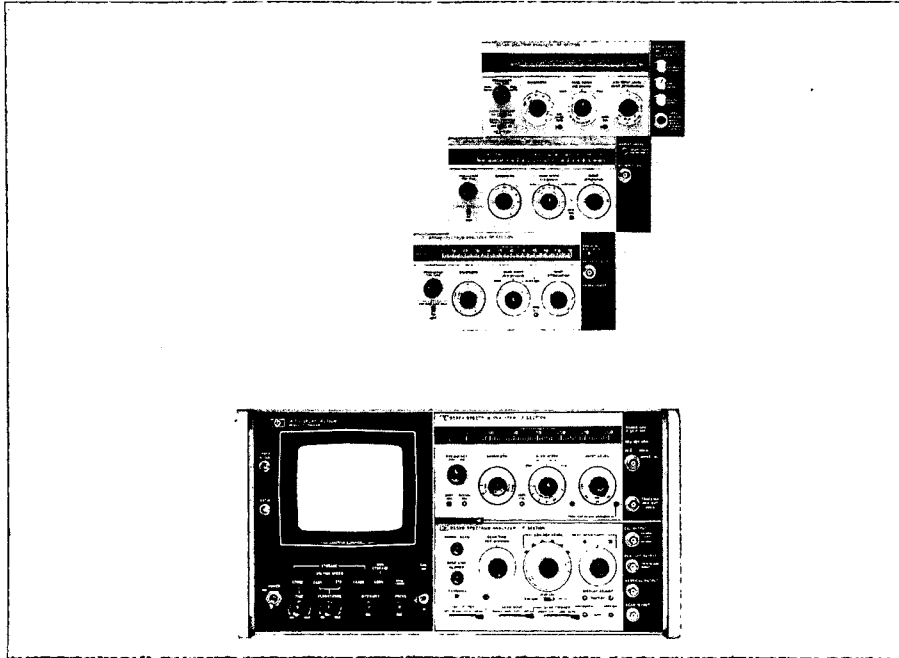

The new 8556A Spectrum Analyzer LF Section covers the important frequency range from 20 Hz to 300 kHz. Now the plug-in spectrum analyzer line offers complete coverage from audio to 40 GHz. A wide combination of tuning sections, IF sections, and display sections allows you to create a system tailored to a specific measurement need. The full spectrum analyzer line features absolute amplitude calibration and fully solid state construction.

The complete line allows measurement at all points of most systems: RF sections, IF's, video sections, and audio circuits as well.

The 8556A is unique in the spectrum analyzer line. Audio measurements are made in a variety of characteristic impedances. Balanced or unbalanced inputs may be used, and open-circuit voltage (dBV or linear) or dBm in several characteristic impedances may be measured. The 8556A is equipped to make measurements corresponding to audio requirements, and absolute calibration becomes an appreciated measurement tool.

The frequency coverage of the 8556A overlaps that of the 1 kHz to 110 MHz tuning section, the 8553B. A question naturally arises—why the 8556A? What does the 8556A offer in the frequency range from 1 kHz to 300 kHz where it overlaps the 8553B? In this frequency range the 8556A offers a wider dynamic range, improved sensitivity, greatly improved center frequency resolution, and greater ease of use than the 8553B. The 8556A also makes the measurements in different impedances with balanced or unbalanced inputs that low frequency engineers need.

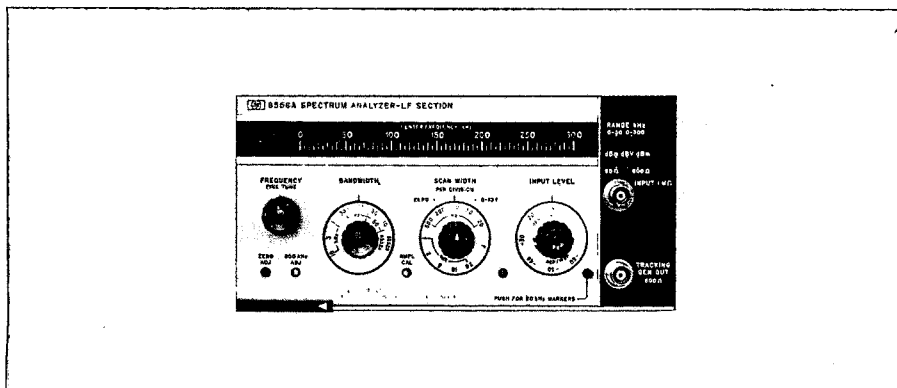

## Features

A number of new features appear on the 8556A. Some are refinements of features common to other HP Spectrum Analyzers, and some are new in concept. Each of the features has been designed to offer the greatest simplicity in operation.

### Absolute Amplitude Calibration

Absolute calibration is common to the complete series of spectrum analyzers, but some new ideas have been used to add flexibility for audio applications. The 8556A not only allows measurement of signal levels in dBm or voltage, but it allows you to measure dBV (dB referred to one volt) or dBm referred to impedances other than 50 ohms as well.

### Isolated Input

The 8556A offers an input which is isolated from the instrument chassis. This gives the 8556A a freedom from line frequency residual responses caused by ground loops that has only been achieved by battery-powered instruments in the past. The high (1 megohm) impedance and low shunt capacitance allow the use of compensated oscilloscope probes with the 8556A.

### Built-in Tracking Generator

Characterization of amplifiers, filters, and other devices is easy with the built-in tracking generator. The tracking generator output is used to amplitude calibrate the display in place of the 30 MHz calibrator which is used with the other tuning sections. Since the tracking generator output precisely tracks the spectrum analyzer tuning frequency, you can use it with an external counter to make accurate frequency measurements for signals appearing on the display. The tracking generator also provides a convenient signal for compensating an oscilloscope probe to be used with the 8556A.

### Crystal Markers

Quick and accurate frequency calibration is possible with the built-in 20 kHz crystal markers. Additional benefits of the crystal markers are the ability to easily check the narrowband stability of the spectrum analyzer and to calibrate the tuning dial.

### 0 - 10f Sweep

Want to sweep test a device from 0 to 20 kHz? Simply set the Scan Width control to 0 - 10f, and the Per Division knob to 2 kHz. The spectrum analyzer is now scanning from 0 to 20 kHz; i.e., 2 kHz per division starting at "zero" frequency. This new sweep mode saves time in attempting to set up a known frequency scan from "zero" to some predetermined upper frequency. Of course, the familiar Per Division sweeps, with a Center Frequency set by the tuning dial, and Zero Scan are still available.

### Wide Dynamic Range

One of the major applications of the 8556A is measurement of distortion on audio test signals. Since a wide dynamic range is required for this measurement, there must be some way to easily optimize the dynamic range before the measurement is made.

On the 8556A this is readily accomplished. Simply set the Input Level control to agree with the signal level read off the CRT, and the dynamic range is optimized for that signal. For example, if the level of a signal is found from the CRT display to be -20 dBV, the Input Level control should be set to -20 dBm/dBV. With other analyzers, it is necessary to determine the signal level and compute an input attenuator setting which will give a known level at the input mixer. The new method is more convenient, and it helps to remind the user of dynamic range considerations. This results in fewer measurement errors.

The applications shown on the following page demonstrate the use of a few of the important features of the 8556A. There are, of course, practically unlimited uses for this spectrum analyzer in the frequency range of 20 Hz to 300 kHz.

## Applications

### Measure Amplifier Distortion

One of the basic spectrum analyzer applications is the measurement of distortion introduced by active devices. In this photo, two  $-30$  dBV signals were fed through a linear summing network to a wideband preamplifier. The signals were at 87 and 97 kHz, the intended operating frequencies. The LOG REF LEVEL was  $-10$  dBV, so the amplifier gain is 20 dB. The spectrum analyzer scan is 0 - 200 kHz, 20 kHz per division. Sec-

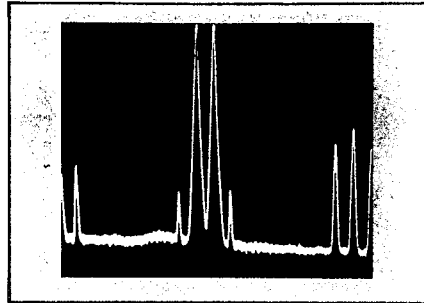

ond harmonic distortion appears at 174 and 194 kHz, 38 dB below the fundamental. Second order intermodulation products appear at 184 kHz, 33 dB down, and at 10 kHz, 44 dB down. Third order IM products are 53 dB down. The 1 kHz IF bandwidth was used to allow resolution of all significant distortion products. Absolute calibration of amplitude (in power or voltage) is important in the measurement of distortion on active devices since the distortion varies with output level. Measurements to IHF and CCIF standards are easily accomplished with this system.

### Measure Electromagnetic Interference (EMI)

The compatibility of devices used in a system demands that certain standards of performance be met in the emission of unwanted energy (EMI). The spectrum analyzer may be used to determine the interference present at each frequency in a very short time by scanning wide frequency ranges. In the photo at the right, the interference conducted to the ac power line by an SCR light dimmer was measured from 0 to 200 kHz. The LOG REF LEVEL (top graticule line) is  $-40$  dBV. Applying appropriate correction factors, we can obtain the interference level in  $\text{dB}\mu\text{A}/\text{MHz}$ . Application Note 63E, "Modern EMI Measurements," describes the technique more fully. The excellent flatness and sensitivity of the spectrum analyzer make it ideally suited for this measurement.

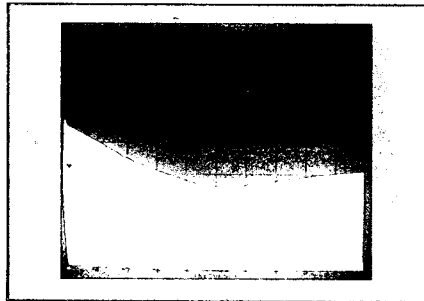

### Measure Oscillator Distortion

The spectrum analyzer is used here to measure the harmonic distortion on a 10 kHz oscillator. The scan is from 0 to 50 kHz; 5 kHz per division. The fundamental is at  $-40$  dBV, and the harmonics are all down 56 dB or more. This represents harmonic distortion of about 0.16%. The 300 Hz bandwidth was used to allow adequate resolution of the distortion products.

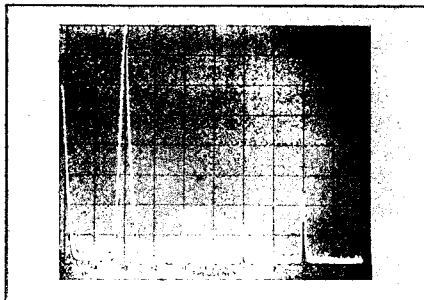

## Control Dictionary

This section provides a general description of the function of the operating controls. The 8552B IF Section is shown here since it will be the primary one for use with the 8556A. The 8552A IF Section may be used in all cases, but frequency resolution is degraded since the 8552A has 50 Hz for the narrowest resolution bandwidth rather than 10 Hz as in the 8552B.

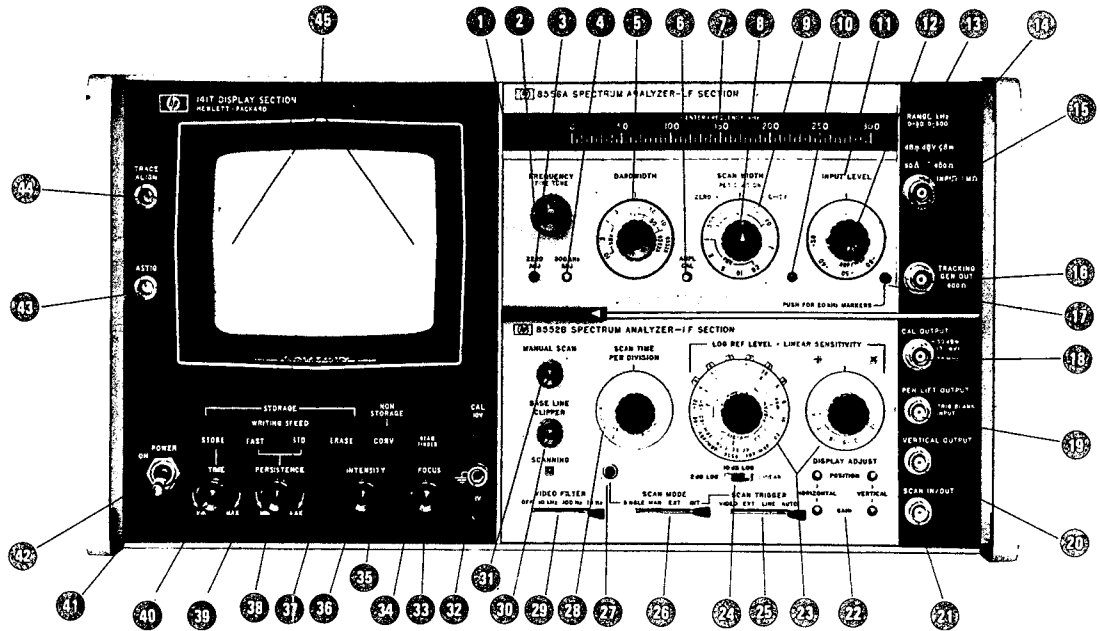

1. **Display Uncal:** warning light indicates that the CRT display has become uncalibrated due to incompatible settings of SCAN WIDTH, SCAN TIME, BANDWIDTH, and VIDEO FILTER controls.
2. **Frequency:** tunes the CENTER FREQUENCY in SCAN WIDTH PER DIVISION and ZERO scan modes. FINE TUNE allows high resolution adjustments in narrow scans.
3. **Zero Adj:** calibrates CENTER FREQUENCY dial for "zero" frequency.
4. **300 kHz Adj:** calibrates CENTER FREQUENCY dial for 300 kHz.
5. **Bandwidth:** selects resolution bandwidth of the spectrum analyzer from 10 Hz to 10 kHz in a 1, 3 sequence. (8552A, 50 Hz and 100 Hz to 300 kHz in a 1, 3 sequence.)
6. **Ampl Cal:** calibrates display amplitude for absolute voltage and power measurements.
7. **Center Frequency:** dial indicates the CENTER FREQUENCY for SCAN WIDTH PER DIVISION and ZERO scan modes. Calibrated in 5 kHz increments for 0-300 kHz range and 500 Hz increments for 0-30 kHz range.
8. **Scan Width:** selects spectrum analyzer frequency scanning mode. 0-10f repetitively tunes the spectrum analyzer from "zero" frequency to ten times the setting of the PER DIVISION control (e.g., with PER DIVISION control set at 1 kHz, scan would be from 0 to 10 kHz, or 1 kHz per division). PER DIVISION mode scans the spectrum analyzer symmetrically about the CENTER FREQUENCY with a SCAN WIDTH set by the PER DIVISION control. In the ZERO scan mode, the analyzer becomes a fixed frequency receiver at the CENTER FREQUENCY.

9. **Per Division:** selects the CRT horizontal calibration (frequency scale) in the PER DIVISION and 0-10f scan modes.
10. **Tracking Adj:** tunes the TRACKING GEN OUT frequency to precisely track the tuning frequency of the spectrum analyzer.
11. **Input Level:** adjusts the input signal level to the input mixer and input pre-amplifier to maximize dynamic range. This control should be set to agree to the maximum signal level read from the CRT.
12. **Tracking Gen Level:** adjusts the output level of the tracking signal present at the TRACKING GEN OUT. When the CAL position is selected, it gives an output of 100 mV for calibrating the spectrum analyzer display. The output can be increased to 3 V.
13. **Range kHz:** selects CENTER FREQUENCY dial range of 0-30 kHz or 0-300 kHz.
14. **dBm - dBV:** selects log display absolute calibration for dBV or dBm referred to 50 ohms or 600 ohms. For correct dBm measurements, an external termination of the proper impedance must be provided for the input signals.
15. **Input:** one megohm unbalanced input for signals to be measured. Option 001 offers the user a balanced 10 kilohm input for use with balanced systems. See the section on special options.
16. **Tracking Gen Out:** signal output tracks the spectrum analyzer tuning frequency. The signal may be used for swept frequency response measurements or to drive a frequency counter for accurate frequency measurements. The signal output also serves to accurately calibrate the display for absolute amplitude.
17. **Push for 20 kHz Markers:** places crystal controlled markers with 20 kHz spacing on CRT. These markers are accurate to 0.01%, and are useful for calibrating the frequency axis.
18. **Cal Output:** -30 dBm, 30 MHz signal used for calibrating amplitude on other tuning sections (8553B, 8554L, 8555A).
19. **Pen Lift Output, Trig/Blank Input:** provides +14 V pen lift signal for use with X-Y recorders during retrace in SINGLE and INT SCAN MODES with VIDEO, LINE, or AUTO SCAN TRIGGER. It serves as an input connector for external blanking signal in the EXT SCAN MODE. When EXT SCAN TRIGGER is selected, it becomes an input connector for the external trigger signal.
20. **Vertical Output:** provides output proportional to vertical deflection on CRT. Approximately 100 mV per major division with 100-ohm output impedance.
21. **Scan In/Out:** provides output voltage proportional to CRT horizontal deflection. 0 volts equal center screen with 1 volt per division (-5 to +5 V full screen). Output voltage available in SINGLE, MAN, and INT SCAN MODES. In EXT SCAN MODE, the connector is used as an input for a 0 to +8 V external scan signal.
22. **Display Adjust:** these controls adjust the deflection circuit gain and offset levels to match the IF section to a particular display section.
23. **Log Ref Level—Linear Sensitivity:** these controls set the absolute amplitude calibration of the CRT display. In the 10 dB LOG or 2 dB LOG modes, the sum of the two control settings determines the LOG REF LEVEL (top graticule line on CRT). In the LINEAR mode, the product of the two control settings determines the CRT scale factor in volts per division. A special knob is provided for use with the 8556A. This knob is described in the section on compatibility.
24. **2 dB Log/10 dB Log/Linear:** selects display mode for logarithmic display with scale factors of 10 dB per division or 2 dB per division or LINEAR display with scale factor selected by LINEAR SENSITIVITY (2 dB per division not available with 8552A).



25. **Scan Trigger:** selects synchronizing trigger when in the INT SCAN MODE.  
**Auto:** scan free runs.  
**Line:** scan synchronized to power line frequency.  
**Ext:** scan initiated by external positive or negative pulses (2 - 20 V) applied to TRIG/BLANK INPUT.  
**Video:** scan internal synchronized to envelope of RF input signal. Signal amplitude of 1.5 divisions peak-to-peak (min.) required on display section CRT.
26. **Scan Mode:** selects scan source.  
**Int:** analyzer repetitively scanned by internally generated ramp; synchronization selected by SCAN TRIGGER. SCANNING lamp indicates time during which analyzer is being scanned.  
**Ext:** scan determined by externally applied 0 to +8 V signal at SCAN IN/OUT.  
**Man:** scan determined by MANUAL SCAN control; scan continuously variable across CRT in either direction. (Not available with 8552A.)  
**Single:** single scan initiated by front panel pushbutton. SCANNING lamp indicates time during which analyzer is being scanned.
27. Initiates or resets scan when SINGLE SCAN MODE is selected.
28. **Scan Time Per Division:** selects time required to scan one major division on CRT display. Control acts as time base for time domain operation in the ZERO SCAN mode.
29. **Video Filter:** post detection low pass filter for effective averaging of distributed signals such as noise. Bandwidths of 10 kHz, 100 Hz, and 10 Hz selectable; nominal bandwidth 400 kHz in OFF position. (10 Hz position not available with 8552A.)
30. **Base Line Clipper:** allows blanking of the bright base line area of the CRT for better photography and improved display of transient phenomena.
31. **Manual Scan:** controls spectrum analyzer horizontal scan in the MAN SCAN MODE. (Not available on 8552A.)
32. **Cal 10 V and 1 V:** 10 V or 1 V square wave used to calibrate time domain plug-ins only.
33. **Focus:** focuses CRT spot for best definition.
34. **Beam Finder:** returns CRT trace to the center of the screen regardless of deflection potentials with time domain plug-ins only.
35. **Nonstorage, Conv:** defeats the storage and variable persistence features of the CRT. Persistence is that of the standard P31 phosphor.
36. **Intensity:** adjusts the intensity of the trace on the CRT.
37. **Erase:** erases the CRT in the WRITING SPEED FAST or STD mode of operation. CRT ready to record immediately after erasure.
38. **Persistence:** adjusts the trace fade rate from 0.1 sec. to more than 2 minutes in the WRITING SPEED FAST or STD modes of operation.
39. **Writing Speed Fast, Std:** these controls select the writing speed of the CRT in the PERSISTENCE mode of operation. The WRITING SPEED STD mode is almost always selected for spectrum analysis applications.
40. **Store Time:** controls the storage time and relative brightness of the display in the STORE mode of operation. Storage time more than 2 minutes at maximum brightness, more than 2 hours at minimum brightness.
41. **Store:** stores the display on the CRT for extended viewing or photography. The CRT does not write in the STORE mode.
42. **Power:** controls power to the mainframe and to both plug-ins.
43. **Astig:** adjusts the shape of the CRT spot.
44. **Trace Align:** used to adjust the CRT trace to align with the horizontal graticule lines.
45. **CRT Graticule with LOG and LIN scales:** LOG REF is the level used to reference the amplitude of displayed signals in the LOG display mode. LINEAR display amplitude is referenced from the baseline.

## Front Panel Adjustment Procedure

These front panel adjustments match the LF and IF sections to the particular display section used. In addition, they allow you to correct for any changes in calibration which may occur over a period of time. These adjustments are a good way to become acquainted with the controls on the spectrum analyzer, and they are a good starting point for the new user becoming familiar with the system.

1. Make the following instrument control settings:

RANGE	0 - 300 kHz
CENTER FREQUENCY	150 kHz
BANDWIDTH	10 kHz
SCAN WIDTH	PER DIVISION
PER DIVISION	20 kHz
INPUT LEVEL	-20 dBm/dBV
dBm 50 $\Omega$ - dBV - dBm 600 $\Omega$	dBV
SCAN TIME PER DIVISION	5 msec
LOG REF LEVEL	-10 dBV
2 dB LOG - 10 dB LOG-LINEAR	10 dB LOG
BASE LINE CLIPPER	MAX CCW
VIDEO FILTER	OFF
SCAN MODE	INT
SCAN TRIGGER	AUTO
WRITING SPEED	STD
PERSISTENCE	MIN
INTENSITY	12 o'clock
POWER	ON

Adjust intensity as needed.

2. Set LOG REF LEVEL maximum counterclockwise. Using the VERTICAL POSITION control, bring the trace to the -40 dB graticule line. Switch the SCAN MODE to MAN, and use the MANUAL SCAN to bring the CRT dot to the center of the screen. Adjust FOCUS and ASTIG for the smallest round dot possible.
3. Set the SCAN MODE to INT. Adjust TRACE ALIGN to set the trace parallel to the horizontal graticule lines.
4. Using the VERTICAL POSITION control, bring the trace to the bottom graticule line (ignore any slight misalignment of the trace). Alternately adjust HORIZONTAL GAIN and HORIZONTAL POSITION so that the trace just fills the bottom graticule line.
5. Connect the TRACKING GEN OUT to the INPUT. Set the TRACKING GEN LEVEL to CAL. Set the VIDEO FILTER to 10 kHz. Use the LOG REF LEVEL vernier to set the trace to the -70 dB graticule line at the center of the CRT. (Some adjustment of the AMPL CAL may be required to place the trace on the line.)
6. Turn the LOG REF LEVEL clockwise 7 steps while observing the trace. The trace should move up the CRT in 10 dB steps. If it does not, adjust VERTICAL GAIN to bring the trace to the top graticule line.

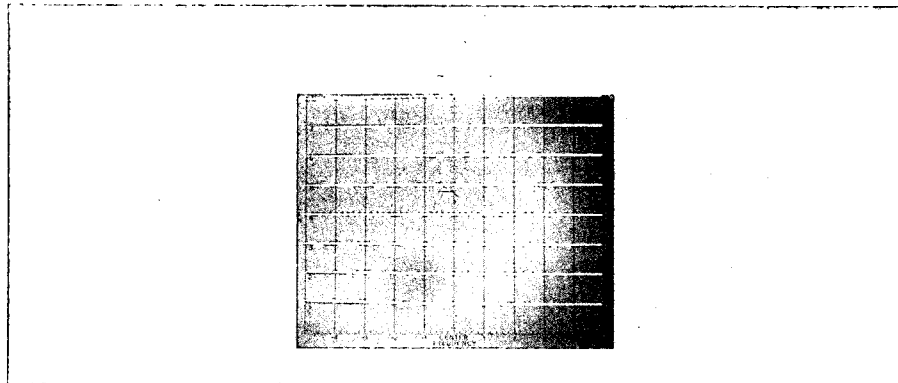

7. Turn the LOG REF LEVEL fully counterclockwise and repeat steps 5 and 6 until no further adjustment is necessary.

8. Set the LOG REF LEVEL to  $-20$  dBV (be sure vernier is at zero). Adjust AMPL CAL to bring the trace to the top graticule line at the center of the screen.
9. Set the 2 dB LOG - 10 dB LOG - LINEAR switch to LINEAR, and set the LINEAR SENSITIVITY to 20 mV per division. Make any fine adjustment of the AMPL CAL that is necessary to bring the trace to the fifth graticule line ( $5 \times 20 \text{ mV} = 100 \text{ mV}$ ).

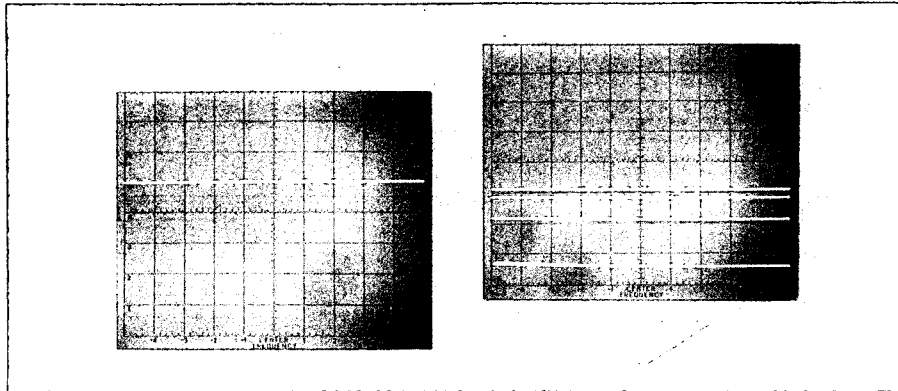

10. Return the 2 dB LOG - 10 dB LOG - LINEAR switch to 10 dB LOG. Set the LOG REF LEVEL to  $-10$  dBV, and set the SCAN WIDTH to ZERO. Reduce the BANDWIDTH to 10 Hz. Adjust TRACK ADJ to bring the trace as high as possible on the screen. Set the 2 dB LOG - 10 dB LOG - LINEAR switch to 2 dB LOG and repeat the peaking procedure. Return to 10 dB LOG.
11. Disconnect TRACKING GEN OUT, and set the SCAN WIDTH to 0 - 10f. Set the PER DIVISION knob to 5 kHz, the BANDWIDTH to 1 kHz, and SCAN TIME PER DIVISION to 50 msec. Adjust the ZERO ADJ to bring the peak of the LO feedthrough to the left edge of the graticule.

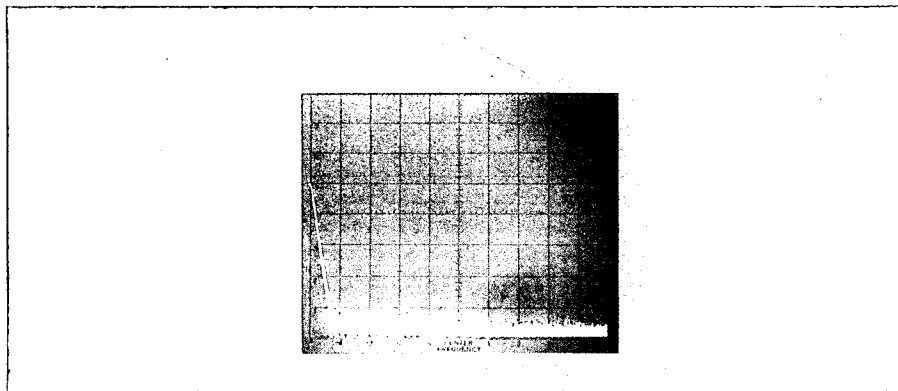

12. Set the BANDWIDTH to 10 Hz, and the PER DIVISION control to 50 Hz. Set the SCAN MODE to MAN. Rotate the MANUAL SCAN control fully counterclockwise. Use the ZERO ADJ to carefully peak the dot on the left edge of the CRT.

This completes the front panel adjustments. Some minor readjustment of the TRACK ADJ and ZERO ADJ controls may be necessary from time to time for narrowband operation. However, this requires only a few seconds, and it may be readily accomplished between measurements.

Adjustment of the 300 kHz ADJ may occasionally be required. This may be accomplished with the aid of the 20 kHz markers. Tune the spectrum analyzer to bring the fifteenth marker (300 kHz) to the center of the screen. The tuning dial should read 300 kHz. If it does not, tune to 300 kHz, noting the position of the 300 kHz marker on the screen. Adjust the 300 kHz ADJ to bring the 300 kHz marker back to the center of the screen.

## Operation

In general, operation of any spectrum analyzer may be accomplished through the following steps:

1. Set the analyzer to scan the appropriate frequency range with the proper resolution.
2. Adjust the amplitude scale as necessary for the application.
3. Complete the measurement and interpret the results.

This section will follow these steps to show the proper operation of the 8556A. In addition, the operation of the built-in tracking generator will be described.

### Setting the Frequency Scale

There are three ways of setting up the frequency scan on the 8556A. First is the 0 - 10f mode of operation. When this mode is selected, the spectrum analyzer scans from "zero" frequency to a preset upper limit selected by the PER DIVISION control. For example, if the PER DIVISION control is set to 10 kHz, and the 0 - 10f mode is selected, the spectrum analyzer scan will be from 0 to 100 kHz, 10 kHz per division. Scans may be selected from 20 Hz per division to 20 kHz per division in a 1, 2, 5 sequence.

The second way to set up a frequency scan is with the SCAN WIDTH PER DIVISION mode. In this mode, the frequency scan is symmetrical about the CENTER FREQUENCY tuned by the FREQUENCY control. The CENTER FREQUENCY dial indicates this frequency in two ranges, 0-30 kHz or 0-300 kHz. The horizontal scale is then selected by the PER DIVISION setting.

Finally, the ZERO scan mode may be selected. The spectrum analyzer becomes a fix-tuned receiver at the frequency indicated by the CENTER FREQUENCY dial. In this mode, amplitude variations are displayed versus time on the CRT.

These scan modes may be selected to match the particular application. For instance, if measurement of harmonic distortion is desired, the 0 - 10f mode would most likely be used. On the other hand, measurement of oscillator spectral purity would best be performed in the PER DIVISION mode. ZERO scan is useful for recovering modulation on a signal.

Once the proper frequency scan is chosen, the resolution needed for the particular application should be determined. Resolution is mainly a function of the IF bandwidth selected. As more narrow IF bandwidths are used, the resolution increases. At the same time, the spectrum analyzer must be swept at a slower rate when narrow bandwidths are used. The bandwidth used, then, should be only as narrow as is necessary for the particular application.

Wide frequency scans, as perhaps used in the measurement of harmonic distortion, may be used with fairly wide bandwidths to allow rapid scanning of the frequency range. However, in order to measure line related sidebands on an oscillator, narrow bandwidths must be used. In this case relatively slow scans will be required. The procedure, therefore, is to select the bandwidth necessary for the desired resolution, and then slow the scan rate (SCAN TIME PER DIVISION) until the DISPLAY UNCAL light goes out.

### Adjusting the Amplitude Scale

Once the desired signals are displayed on the CRT, the amplitude may be set to give the optimum display. The first consideration is to decide how the amplitude is to be measured. That is, should the amplitude be specified in power or voltage? The 8556A can measure power in dBm (for 50  $\Omega$  or 600  $\Omega$  systems), and it can measure voltage on a linear scale or in dB referred to one volt (dBV) on a log scale.

If power is the desired parameter, set the dBm-dBV switch to dBm for the appropriate impedance (600  $\Omega$  or 50  $\Omega$ ). The input should then be terminated, either with a feedthrough termination for the impedance selected or be connected across a transmission line that is externally terminated in the appropriate impedance.

For voltage measurements, the dBm-dBV switch can be set to dBV for a log display, or the LOG-LINEAR switch can be set to LINEAR for a linear display. If no feedthrough termination is used, the spectrum analyzer will display the open circuit voltage. If a feedthrough termination is used, the voltage displayed will be that developed across the impedance of the termination.

The next step is to ensure that the spectrum analyzer is operating linearly. That is, that all spectral components displayed are indeed present at the input and not generated in the spectrum analyzer. This is readily accomplished. Simply read the amplitude of the largest signal on the CRT, and set the INPUT LEVEL control to the nearest setting to this amplitude. For example, if the largest signal on the

display is at  $-13$  dBV, the INPUT LEVEL control would be set to  $-10$  dBm/dBV.

Now simply set the LOG REF LEVEL or LINEAR SENSITIVITY controls to give the desired display. One convenient way to set the LOG REF LEVEL is to set the  $-10$  dBm/dBV position under the right-hand indicator light. The  $-60$  dBm/dBV position will then fall under the left-hand indicator light. In this position, setting the INPUT LEVEL control to the amplitude of the largest signal will bring that signal to the top of the CRT. This gives you the widest possible display dynamic range for signals between  $-60$  dBm/dBV and  $-10$  dBm/dBV.

#### Examples

At this point, it may be helpful to go through a few examples to show how this operates in real situations.

**Measure Harmonic Distortion on a Low Frequency Signal:** In this first example let's assume we want to measure the harmonic distortion on the 60 Hz ac power line. (In the photo shown, the power was attenuated by a resistive divider network to avoid damage to the analyzer.) For harmonic measurements, the 0-10f scan mode is useful. Therefore, we set the SCAN WIDTH to 0-10f and the PER DIVISION control to 100 Hz. This allows us to scan from 0 to 1 kHz, and we can measure the fundamental through the sixteenth harmonic.

Since the harmonics are spaced 60 Hz apart, a narrow BANDWIDTH will be required to resolve the spectral components. In this case the BANDWIDTH was set to 10 Hz. Now the SCAN TIME PER DIVISION is increased until the DISPLAY UNCAL light goes out.

Now to set up the amplitude scale, we must decide on a calibration mode. In this case it makes sense to measure the amplitude in voltage, and a log scale is desired in order to see low level harmonics. Therefore, the LOG-LINEAR switch is set to 10 dB LOG, and the dBm-dBV switch is set to dBV.

The amplitude of the fundamental is measured at  $-20$  dBV (100 mV), so the INPUT LEVEL is set to  $-20$  dBm/dBV. To obtain maximum display range now it is only necessary to set the LOG REF LEVEL to  $-20$  dBV.

The harmonic distortion can now be measured directly from the CRT. The third and fifth harmonics appear in this case 32 dB below the fundamental.

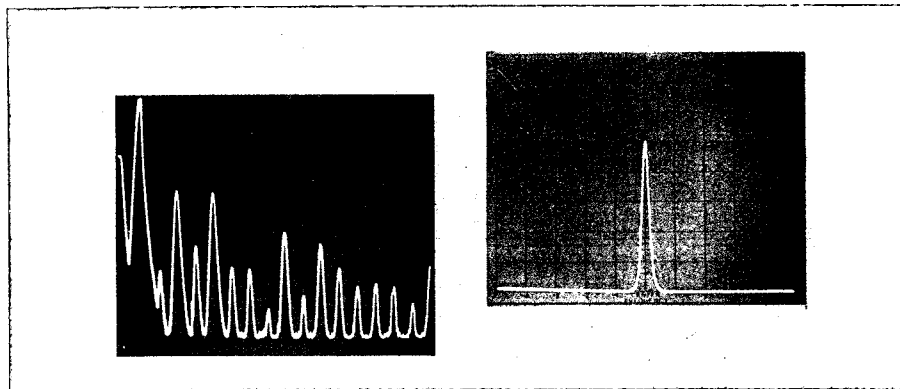

**Measure Voltage and Hum Modulation on an Audio Oscillator:** In this example, the high resolution of the spectrum analyzer will be used to investigate hum modulation on an oscillator. First, though, we would like to measure the amplitude in voltage. The oscillator operates at a frequency of 100 kHz, so we set the SCAN WIDTH to PER DIVISION and the CENTER FREQUENCY to 100 kHz. Since high resolution is not important for an amplitude measurement, we will use a fairly wide BANDWIDTH to allow rapid scanning of the spectrum analyzer. So we set the PER DIVISION control to 5 kHz and the BANDWIDTH to 1 kHz. Now we slow the scan until the DISPLAY UNCAL light goes out.

To measure voltage, we use the LINEAR display. The INPUT LEVEL control is set to  $-10$  dBm/dBV to ensure that there is no gain compression occurring in the analyzer. This setting may be altered as necessary if the display amplitude appears too low later.

The LINEAR SENSITIVITY is now adjusted for a convenient on-screen display. In this case, the level turns out to be 10 mV. To obtain a proper display, the INPUT LEVEL was reset to  $-40$  dBm/dBV, and the LINEAR SENSITIVITY is 2 mV per division.

At this point we are ready to measure the hum sidebands. Since higher resolution and a log display are required, some control changes will be necessary.

First, we narrow the scan to 50 Hz per division while keeping the signal centered on the screen. The BANDWIDTH will then be set to 10 Hz, and the SCAN TIME PER DIVISION is slowed until the DISPLAY UNCAL light goes out.

Since the signal level was previously measured as 10 mV (-40 dBV), we can now set the LOG-LINEAR switch to 10 dB LOG and the LOG REF LEVEL to -40 dBV. This will bring the oscillator output to the top of the CRT. The hum sidebands can now be measured from the display.

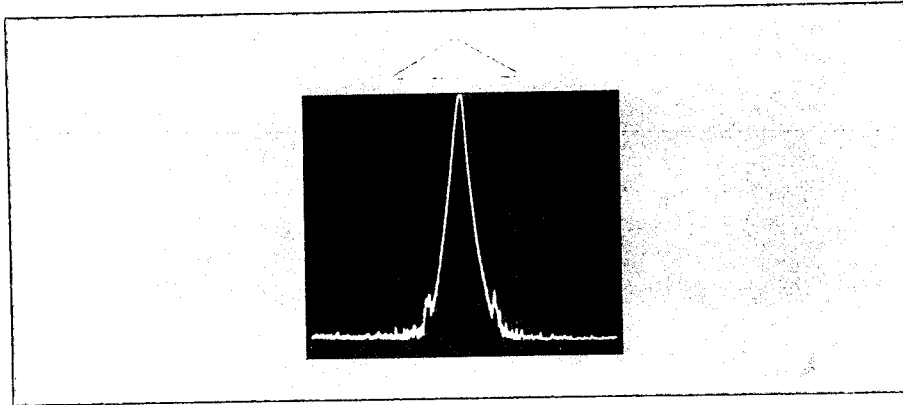

**A Good Way to View High Resolution Spectra:** As you have probably noted, high resolution spectrum analysis requires slow scanning rates. The variable persistence display section is useful in obtaining a bright, steady display.

A good way to use the variable persistence feature is to set up the spectrum analyzer display using minimum persistence. Then select the SINGLE SCAN MODE, erase the CRT, and turn the PERSISTENCE control to MAX. Start the scan by pushing the button on the front panel, and allow the scan to proceed until the SCANNING light goes off. Now push the STORE button on the display section, and adjust the TIME control for the desired intensity. (Note: The brighter the display, the shorter the storage time.)

**Use of the Built-in Tracking Generator:** The tracking generator is a flat signal source whose output frequency precisely tracks the spectrum analyzer tuning frequency. This output may be used as a source to test devices for frequency response. Also, by measuring the frequency of the tracking generator output with a frequency counter, you can precisely determine the frequency of signals appearing on the spectrum analyzer display.

**Frequency Response Measurements:** The frequency scan of the spectrum analyzer is set up in much the same way as described earlier. The tracking generator output frequency is determined by the spectrum analyzer scan. If a device is being tested from 0 to 20 kHz, it is only necessary to set the spectrum analyzer to scan 0 - 20 kHz using the 0 - 10f mode.

The device under test will be connected in the signal path between the TRACKING GEN OUT and the INPUT. Some consideration must be given here to the input and output impedances of the test device.

If a driving impedance of 600 ohms is desired, the tracking generator may be connected directly to the device. The 50-ohm tracking generator shunt supplied with the 8556A may be used between the tracking generator and the test device to provide a driving impedance of 50 ohms.

The 50-ohm or 600-ohm feedthrough terminations may be used as ac and dc device terminations, and high impedance devices may be connected directly to the spectrum analyzer input. For the testing of amplifiers or other systems in which a different impedance is desired, a simple resistive termination may be used. An oscilloscope divider probe may be used to provide less shunt capacitance and higher impedance than the direct input.

The tracking generator level is 100 mV open circuit in the CAL position. This amounts to 50 mV (-26 dBV) across 600 ohms. If the tracking generator shunt is used, the output will be 8.34 mV into an open circuit or 4.17 mV (-34.6 dBm) into a 50  $\Omega$  load. The output level increases as the TRACKING GEN LEVEL is moved off the CAL position.

**System Calibration:** The TRACKING GEN OUT should be connected through any necessary terminations to the spectrum analyzer INPUT. The TRACKING GEN LEVEL can then be adjusted to bring the trace to the top graticule line, thus providing a convenient reference. The INPUT LEVEL control should be set to  $-20$  dBm/dBV and the LOG REF LEVEL set to 0 dBm/dBV for maximum measurement range on devices which do not have gain. (Use the dBm scale for 50-ohm devices and the dBV scale for 600-ohm devices for convenience.)

Insert the test device in the circuit, and its frequency response will be displayed directly on the CRT. Insertion loss may be read directly from the dB scale on the graticule.

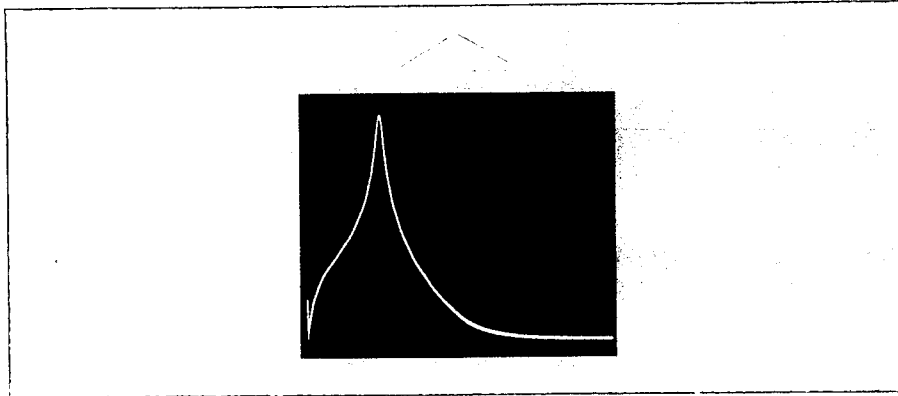

**Testing Amplifiers:** In order to measure amplifier frequency response, some provision must be allowed for the gain of the amplifier to prevent damage to the spectrum analyzer or the amplifier input. A step attenuator should be added to the test setup to allow decreasing the tracking generator level by a known amount.

The calibration procedure remains the same with the attenuator set to the 0 dB position. Then the attenuation should be increased by an amount greater than the gain of the amplifier under test. The gain of the amplifier will be the sum of the attenuator setting and the dB reading from the CRT graticule at any point. (Remember this is a negative number on the graticule.) For example, the spectrum analyzer is calibrated for a reference at the top of the CRT. Now a test amplifier is inserted, and the attenuator is set to 50 dB. If the amplifier response curve is at the  $-7$  dB graticule line, the gain is 43 dB (50 dB  $-7$  dB).

**Important Considerations:** When using the tracking generator for swept response measurements, the spectrum analyzer BANDWIDTH and DISPLAY UNCAL light take on somewhat different significance. The BANDWIDTH setting mainly affects the average noise level and has only a secondary effect on resolution. Narrowing the BANDWIDTH improves dynamic range, but requires slower sweep rates. The DISPLAY UNCAL light in most cases will not be applicable. The general rule to apply in swept response measurements is to slow the scan rate until the display amplitude remains constant with changes in SCAN TIME PER DIVISION. At this point, the scan is the proper rate to satisfy the requirements of both the spectrum analyzer and the device under test.

Spurious responses are not displayed on the CRT due to the tracking signal source and receiver. Therefore, measurements may be made over a dynamic range limited only by gain compression as an upper limit and system noise as a lower limit.

Devices such as filters, which may have attenuation greater than 100 dB can be measured. The response can be traced out on the CRT in two 70 dB segments, and the results can be photographed to give a composite picture.

**Using the Tracking Generator for Precise Frequency Measurements:** It may be desired to measure the frequency of a low level signal which is close to a higher level signal. With a conventional frequency counter, this is extremely difficult.

A low frequency counter may be connected to the tracking generator output to accomplish this task. First, adjust the generator tracking as previously described, then, using the MANUAL SCAN mode, scan the spectrum analyzer until you reach the peak of the signal response. The frequency displayed on the counter is the frequency of the signal since the tracking generator precisely tracks the spectrum

analyzer tuning frequency. Resolution of 1 Hz is possible with narrow scan widths and bandwidths on the spectrum analyzer. (The counter gate time for this resolution is 1 second.)

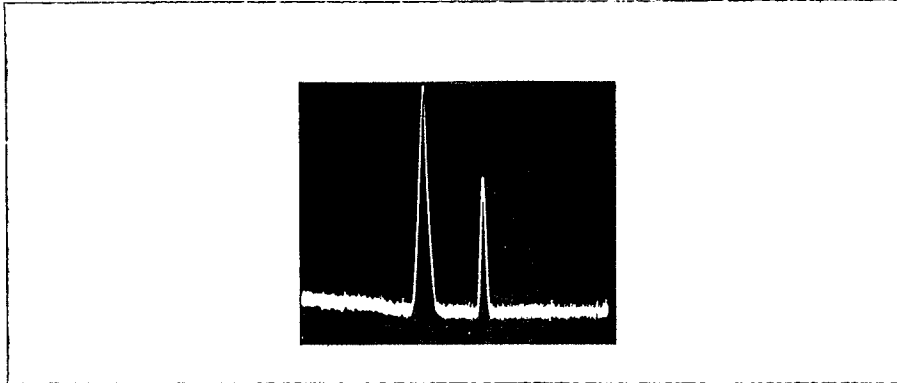

This same method may be applied to the measurement of points on a frequency response curve. If a high impedance counter is used, it may be connected to the tracking generator output on a tee with the test device. Then, manually scanning to a point of interest on the response curve will yield a direct readout of the frequency. This is useful in the measurement of the 3 dB or 6 dB bandwidth of a filter, discontinuities in a response characteristic, or identifying spurious modes on a device.

**First Mixer Balance:** The first mixer in the 8556A is carefully balanced to ensure a low level of first local oscillator feedthrough appearing on the display and limiting dynamic range. With the calibration selector set to dBm - 50 ohms and the INPUT LEVEL set to  $-60$  dBm/dBV, the first LO feedthrough ("zero frequency marker") should appear below  $-80$  dBm. Occasionally this will require adjustment. This is simple, however, requiring only a few minutes. Proceed as follows:

1. Remove the four screws securing the top cover on the display section, and slide the cover off.
2. Tune the spectrum analyzer to zero frequency in the SCAN WIDTH PER DIVISION mode.
3. Terminate the input with the 50-ohm feedthrough termination, select the dBm - 50-ohm calibration, and set the INPUT LEVEL control to  $-60$  dBm/dBV.
4. Using a **nonmetallic** alignment tool, alternately adjust the two trimmers marked as "Mixer Balance Adjustments" to obtain a null of the LO feedthrough.
5. Reinstall the top cover on the display section.

This completes the procedure.

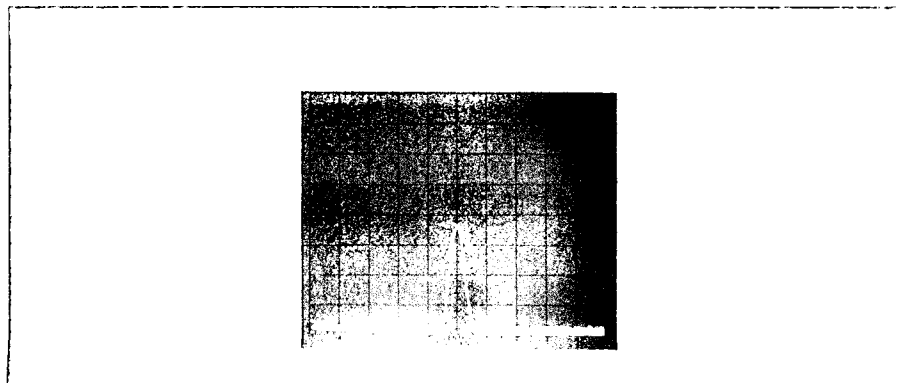



### Compatibility

As part of a plug-in spectrum analyzer system, it is important that the 8556A be compatible with other component parts of the system. Sometimes to achieve this goal of compatibility, modifications are required to some units already in service. This is the case with some 8552A and 8552B IF sections. The modification consists of adding one wire to the IF section; this is simple and can be completed quickly. All 8552A and 8552B IF sections now being shipped are modified. 8552A's with serial prefix 991 and below must be modified, and 8552B's with serial prefix 977 and below must also be modified. Service Notes are available which describe the procedure, and as was stated earlier, it is quite simple.

The log calibration of the 8556A is in dBm or dBV in contrast to the other tuning sections which are calibrated only in dBm. Also, since the signal is amplified prior to entering the input mixer, this offset must be accounted for in the calibration. To do this, a special knob is used on the IF section in place of the standard LOC REF LEVEL control. The special knob has three scales instead of two. One is used for the 8556A LOG calibration, one for the LOG calibration with other tuning sections, and the third is used for the LINEAR calibration with all units. This knob and an Allen wrench to install it are supplied with each 8556A. Extra knobs are available from the Customer Service Center.

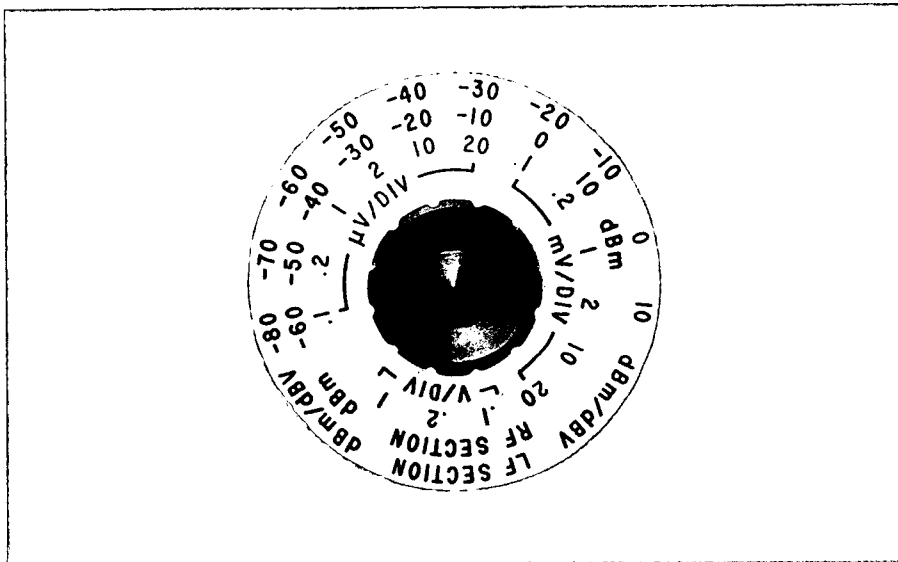

One interesting use of the special knob with the 8553B RF section is a 20 dB gain preamplifier (such as the 8447A). The 8556A scale on the LOG REF LEVEL knob will give the proper calibration (in LOG only) without having to worry about the 20 dB correction.

Although the 8556A works well with either the 8552A or 8552B IF sections, the performance is considerably better with the 8552B. For this reason, the specifications presume the use of an 8552B in all cases. Typical performance with an 8552A is also shown on the data sheet for those who are interested.

### Special Options

The 8556A is designed with flexibility in mind. In the frequency range covered by this instrument, numerous characteristic impedances are common, and systems may be either balanced or unbalanced. This dictates a need for an instrument which is readily adaptable to a specific requirement.

#### Option 001 — Balanced Input

Option 001 is a balanced input version of the 8556A. The input is transformer coupled for proper isolation and high common mode rejection. The amplitude scale is calibrated for dBm into 600 ohms, 900 ohms, and 135 ohms with a balanced input. The tracking generator output has a characteristic impedance of 600 ohms, unbalanced.

#### Optional Calibrations

The 8556A may be ordered with absolute calibration for dBm into impedances between 50 and 1000 ohms. Consult the factory for price and delivery.

## Theory of Operation

This section is intended to give you a working knowledge of the function of the 8556A Spectrum Analyzer system. The operation of some of the front panel controls will be described in order to allow a more complete understanding of the overall system.

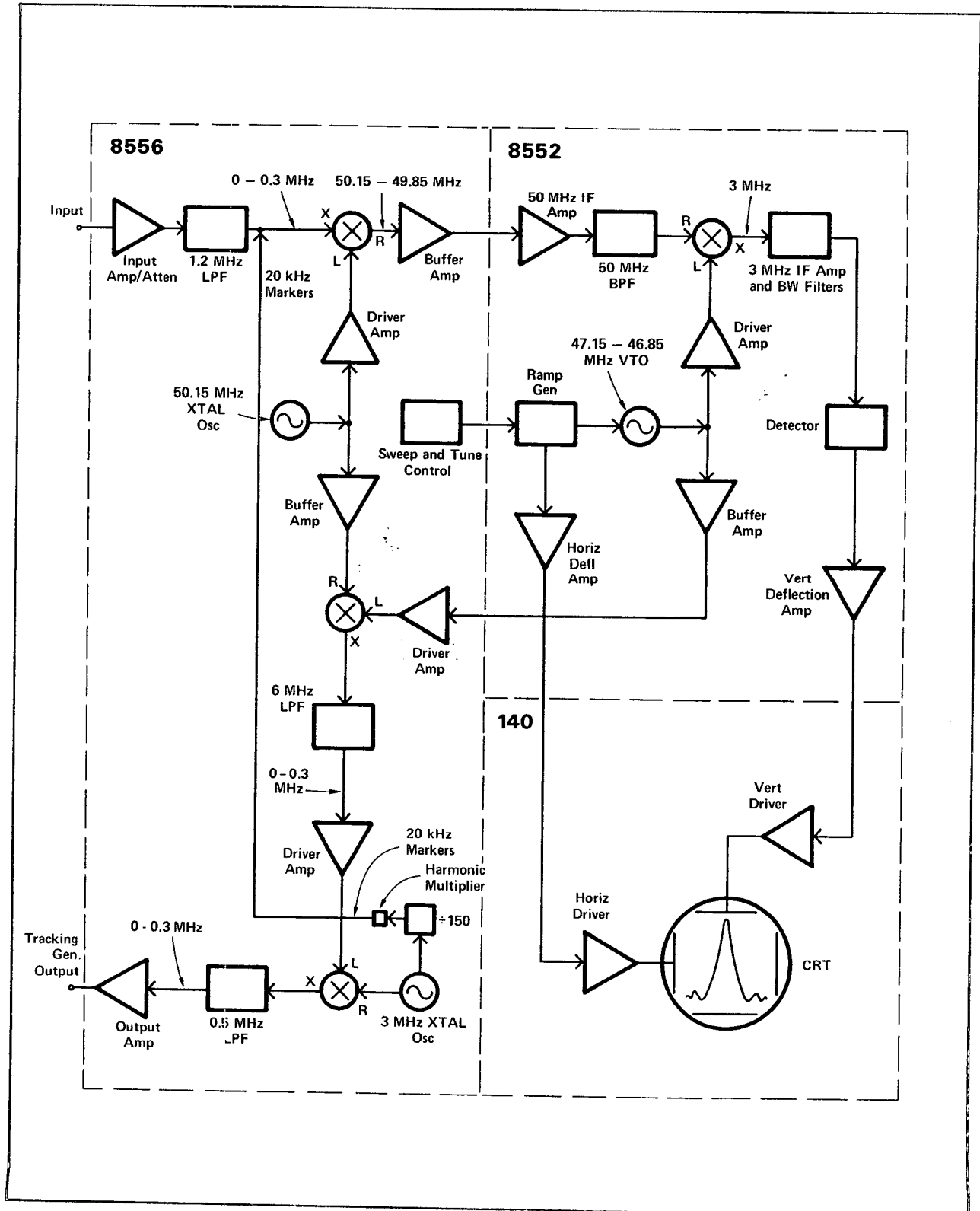

The 8556A is basically a double conversion receiver with a swept second local oscillator. The block diagram on page 14 shows the main functional components.

An input signal passes through an amplifier-attenuator network which serves two purposes. First, it adjusts the signal level to the input mixer to an optimum level for a wide dynamic range. Second, the gain is adjusted to the proper level to agree with the calibration selected. For example, the gain in the input amplifier will be different for dBm in 600 ohms than it will for dBm in 50 ohms. This gain compensation is made automatically for the calibration mode in use.

After passing through a low pass filter, the conditioned signal goes to the first mixer. Here the signal is mixed with a 50.15 MHz fixed local oscillator, and the resulting mixing products are passed by the 50 MHz bandpass filter in the IF section.

The lower sideband (50.15 - 49.85 MHz) is mixed with a 47.15 - 46.85 MHz voltage tuned oscillator to produce a 3 MHz signal which is passed by the 3 MHz IF amplifier. The IF bandwidth is determined by the filters in the 3 MHz IF. The gain of this amplifier is selected by the LOG REF LEVEL-LINEAR SENSITIVITY controls to maintain the CRT calibration. The IF signal is then detected and fed to the vertical deflection amplifier and driver to form the vertical signal for the CRT.

The tuning of the 47 MHz VTO is accomplished through the use of an internal voltage ramp generator. The tuning voltage is controlled by the scan width and tuning controls in the LF section. The voltage ramp is also used to generate the horizontal deflection signal for the CRT.

A portion of the 47 MHz swept local oscillator signal is fed back to the LF section and mixed with a portion of the 50.15 MHz local oscillator signal. The 3.0 - 3.3 MHz difference signal is selected by a low pass filter and mixed with a 3 MHz signal which is adjusted by the TRACK ADJ to match the 3 MHz IF of the system. The resulting 0 - 300 kHz mixing product passes through the low pass filter and appears at TRACKING GEN OUT on the front panel. The frequency of this signal precisely tracks the tuning frequency of the spectrum analyzer.

The 3 MHz oscillator signal is also used to derive the 20 kHz crystal markers. The fundamental frequency is divided by 150 to produce a 20 kHz signal. A harmonic generator produces a frequency "comb" based on this 20 kHz frequency output. This comb is injected into the first mixer to produce a series of signals spaced 20 kHz apart on the CRT display.

At this point, a short discussion of some of the important considerations in maintaining system performance is in order. First, it should be noted that for maximum dynamic range the first local oscillator "feedthrough" must be kept to a low level. If the signal is too high, the IF amplifiers will be overloaded, and spurious responses will be generated. The balance of the first mixer, then, is important. The first LO signal is balanced out by 70 to 80 dB in the mixer to reduce the possibility of spurious responses.

Another potential source of problems is the second local oscillator. If the frequency of this oscillator changes by 1%, the tuning dial would be in error by 470 kHz (150%)! Therefore, this oscillator must be extremely accurate. The ZERO ADJ control on the front panel allows for any slight adjustment which may be necessary to correct for drift in the LO frequency. The 47 MHz LO in the 8552B IF section is much more stable with changes in temperature than that in the 8552A IF section. This is one reason why the 8552B is the logical choice for use in the 8556A system. Second LO accuracy is not a problem with the 8556A.

The input impedance of the 8556A is 1 megohm. In order to make measurements on 600-ohm or 50-ohm systems where dBm is the desired parameter, a feed-through termination should be used. These are included with the 8556A or may be purchased separately.

Also, since the output impedance of the tracking generator is 600 ohms, measurements on 50-ohm devices require a 600- to 50-ohm matching shunt. This shunt is also included with the spectrum analyzer.

HEWLETT  PACKARD