

RADAR SYSTEM CHARACTERIZATION and TESTING

 HEWLETT
PACKARD

Using the HP 5345A Electronic Counters

Application Note 174-14

May 1987

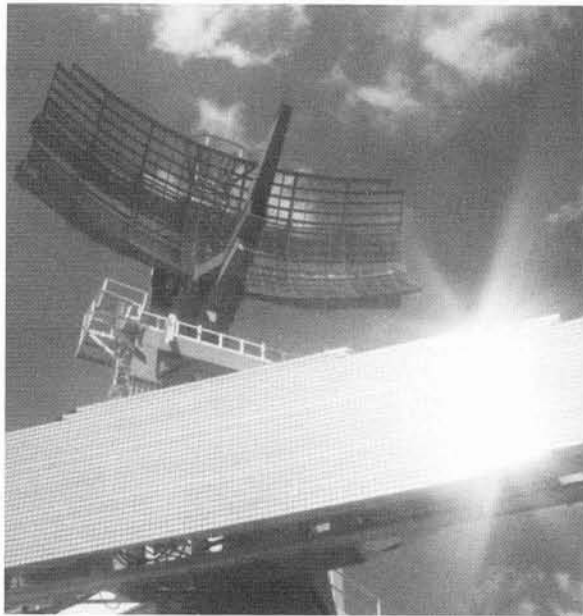

Courtesy Westinghouse



Courtesy Radar Systems Group, Hughes Aircraft Company



**Includes New Barker Code
Analysis Technique**

TABLE OF CONTENTS

| | |
|--|-----------|
| I. INTRODUCTION | 1 |
| A. Basic objective | |
| B. Application description | |
| II. RADAR SYSTEMS | 3 |
| A. Basic radar systems | |
| 1. Operational requirements | |
| 2. Early radar systems | |
| 3. Summary description | |
| 4. Applications | |
| B. Modern radar systems | |
| 1. Operational requirements | |
| 2. Modern radar types | |
| 3. Summary description | |
| III. RADAR SYSTEM CHARACTERIZATION | 7 |
| A. Radar test and evaluation | |
| B. Technical testing | |
| IV. HP 5345 ELECTRONIC COUNTER | 13 |
| A. Technical performance specifications | |
| B. Radar signal measurements | |
| V. RADAR TEST RESULTS | 19 |
| A. Introduction | |
| B. AN/SPS-10E Radar system | |
| 1. Radar technical characteristics | |
| 2. Transmitter subsystem test measurement configurations | |
| a. Radar waveform parameter measurements | |
| b. Radar waveform average frequency profile | |
| 3. Test results | |
| a. Frequency/Time interval measurements | |
| 1. Radar frequency | |
| 2. Radar pulse width | |
| 3. Radar pulse repetition period | |
| 4. Radar pulse repetition frequency | |
| b. Average frequency profile signature measurements | |

V. RADAR TEST RESULTS (continued)

C. AN/SPS40A Radar System

- 1. Radar technical characteristics**
- 2. Transmitter subsystem test measurement configurations**
 - a. Radar waveform parameter measurements
 - b. Radar waveform average frequency profile
- 3. Test results**
 - a. Frequency/Time interval measurements
 1. Radar frequency
 2. Radar pulse width
 3. Radar pulse repetition frequency
 - b. Average frequency profile

D. AN/SPS65(V)1 Radar system

- 1. Radar technical characteristics**
- 2. Transmitter subsystem test measurement configurations**
 - a. Radar waveform parameter measurements
 - b. Radar waveform average frequency profile
- 3. Test results**
 - a. Frequency/Time interval measurements
 1. Radar frequency
 2. Radar pulse width
 3. Radar risetime/falltime
 - b. Average frequency profile

VI. PHASE CODED RADAR PULSE PARAMETER MEASUREMENTS 51

- A. Introduction**
- B. Measurement Set Up**
- C. Barker Coded Pulse Average Frequency Profile**
- D. Characteristics of a Barker Coded Phase Shift**
- E. Reference Clock to Pulse Leading Edge Jitter**

VII. CONCLUSIONS 61

REFERENCES 63

APPENDIX A 65

APPENDIX B 69

I. INTRODUCTION

This application note is designed to meet two basic objectives:

- TO DEMONSTRATE THE HP 5345A ELECTRONIC COUNTER PERFORMANCE CAPABILITIES FOR SOLUTION OF SOME RADAR TEST AND CHARACTERIZATION PROBLEMS.
- TO PERFORM ACTUAL RADAR TRANSMITTER SUBSYSTEM CHARACTERIZATION AND PRESENT TEST RESULTS.

Key features of the HP 5345A, 5355A, 5356A/B/C/D Electronic Counter/Frequency down conversion combination are its abilities to make precision time interval parameters measurements, frequency parameter measurements, and average frequency profile measurements. The quantitative measurement performance capability of this combination is dramatically enhanced by interfacing (HP-IB bus) the HP 5345A Electronic Counter with a HP 9000 Series 200 or 300 Computer. Complex measurements and data collection, that would require much interaction and considerable time by a skilled user under manual operation, are performed automatically.

Radar waveform characteristics are measured and quantified (during radar system and subsystem tests) to determine technical characteristics and operational performance capabilities of the radar sensor. Fine grain statistical analysis of radar waveform parameters are required to determine and quantify these performance capabilities. Radars are required to perform target detections, separate targets, locate targets, and other functions in dense and demanding target environments. Operational radar performance capabilities are quantified by range measurement accuracy, range resolution, range ambiguities, noise characteristics, clutter rejection, and other technical characteristics.

These technical characteristics are directly related to radar waveform parameters and characteristics. Radar pulsewidth (PW) parameter is directly proportional to the range resolution. High range resolution provides operational capability to separate closely spaced targets. Clutter rejection can be accomplished by improving radar range resolution, which requires shorter PW. Also, the accuracy of doppler frequency (target relative velocity) measurement is inversely proportional to PW.

RF pulse risetime parameter is directly related to the accuracy of the target range measurement. Radar bandwidth can be determined from pulse risetime measurements.

The maximum unambiguous range is associated with the time between the leading edge of one radar pulse to the next radar pulse, that is, the maximum distance at which the roundtrip to a target can be completed before the next RF pulse is transmitted. The maximum unambiguous range is inversely proportional to the radar's pulse repetition frequency (PRF).

Many radar waveform parameters play a vital role in determining ECCM (Electronic Counter Countermeasures) capabilities of radar systems. Maximum immunity to hostile Electronic Warfare systems is operationally required; thus, radar waveform parameter measurements are essential for complete technical testing and operational capability evaluation of a radar system.

Selection of test equipment is particularly important in testing and evaluation of the radar system. High performance test instruments will not affect the signal or color the results therefore permitting radar optimization.

In this note, a statistical analysis is performed automatically on collected and stored radar parameter data sets. Radar parameter point plots and probability density function histograms are also presented. Radar average frequency profile signature data are automatically collected, stored and analyzed. This fine grained analysis would be inconceivable using manual data collection methods, but are required to fully quantify radar system performance characteristics.

Radar parameter test measurements are performed on the AN/SPS-10E, AN/SPS-40A AND AN/SPS-65(V)1 radars. Radar frequency, pulsewidth, pulse repetition period, pulse repetition frequency and average frequency profile signature data sets are collected, analyzed and presented.

Data collection and statistical analysis software programs utilized in the preparation of this application note are available, see Appendix B.

II. RADAR SYSTEMS

A. INTRODUCTION

The word "Radar" is an acronym derived from the phrase "radio detection and ranging." Early radar systems were employed to provide detection, range and angle information associated with approaching hostile aircraft and for directing anti-aircraft weapons. (Reference 1.) Modern radar requires a much broader definition than improved detection, range and angle measurement. Modern radar also requires a new high resolution signature, target imaging, target recognition, classification and identification functions and multi-mode operational capabilities. The following subsections will expand upon basic and modern radar systems.

B. BASIC RADAR SYSTEMS

(1) Operational Requirements

Radar can be thought of as a system which extends one's sensory horizon with respect to distance; moreover, it can "see" through conditions such as darkness, haze, fog, smoke and precipitation. The radar enables us to "see" things, i.e. fixed structures, vehicles, the earth's surface, aircraft, ships, and space-based objects. The detected target echo signal provides measureable quantities of "target information" such as range-to-the-target, target angle and doppler (velocity).

(2) Early Radar Systems

This section is limited to a summary discussion of early radar types.

Pulsed radar measures range to the target by determining the round trip travel time of the radar signal.

CW radar system measures doppler frequency or target velocity, but cannot measure target range. FM modulation of the CW radar's carrier frequency, as a function of time in a known manner, will provide target range information.

Pulsed Doppler radars are capable of measuring doppler shift and target range information. The use of doppler information to separate small moving targets in the presence of clutter is a fundamental contribution.

MTI radar utilizes doppler frequency shift to discriminate between moving and fixed targets. Early non-coherent types compared "scan returns," whereas more recent coherent radars compare pulse-to-pulse target returns. The pulse repetition frequency of MTI radars is usually chosen to avoid range ambiguities, while the pulse repetition frequency of Pulse doppler radar is selected to avoid velocity ambiguities. (Reference 1.)

(3) Summary Description

A basic pulsed radar consists of a transmitter, receiver, display and one or more antennas as functionally displayed in *Figure 1*. An RF waveform generated by the transmitter and pulse modulator is sent through the antenna and emitted as an electromagnetic wave (EM) into space. If a portion of the transmitted signal strikes an object, some of the resulting returned wave is collected by the radar's receiver antenna and detected in the radar receiver. This EM wave (echo) will be a significantly attenuated version of the transmitted signal and delayed in time (target range information.) The EM wave can also be shifted in frequency and altered in both amplitude and phase. These variations are due to the target characteristics and intervening medium characteristics.

The radar receiver processes the target return signal to perform target detection and measures range, azimuth and elevation angles and relative target velocity parameters. Detection is a function of the relative strength of the reflected signal with respect to environmental and system generated noise. Range to the target is derived from the time between signal transmission and target signal detection.

Azimuth and elevation angles are a function of direction-of-arrival of the detected signal. These angles are normally obtained through the use of narrow antenna beams.

Target motion relative to the radar platform will produce a shift in the carrier frequency of the reflected EM wave relative to the transmitted wave. This variation is called "Doppler Frequency Shift." This Doppler Frequency Shift can be used to determine the relative radial component of velocity of the target.

Key radar transmitter parameters are frequency, bandwidth, peak power/average power, PRF and spectral purity. Common radar waveforms are generically described as short pulse, long pulse or CW, linear FM, phase coded, coherent pulse train and noise like. These waveforms are selected to satisfy operational and technical requirements for target detection, parameter measurement resolutions and accuracy, ambiguity resolution and clutter rejection.

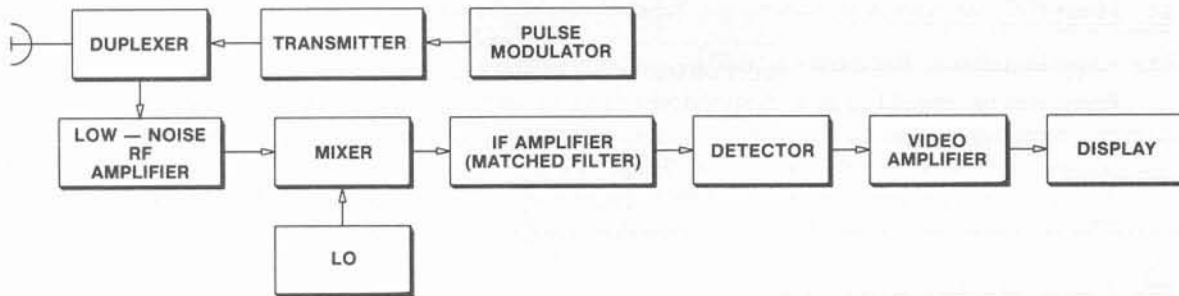

Figure 1. Basic Radar Block Diagram

(4) APPLICATIONS

Radar is vital to virtually all military operations. Some special military radar applications include search and surveillance, early warning, missile guidance, fire control and proximity fusing. Joint military and civil radar applications include air traffic control, weather avoidance, navigation, maritime use, mapping, sounding and space operations.

C. MODERN RADAR SYSTEMS

(1) Operational Requirements

Many radar applications cannot be accomplished with the basic pulsed radar. Thus modern radar systems must go beyond the basic operational requirements of detection, range determination, azimuth angle, elevation angle and doppler frequency measurements. Modern radar operational requirements also include enhanced detection capability, improved range resolution, significantly enhanced angle resolution and improved doppler frequency resolution. New radar systems designed to meet these operational requirements are capable of providing target imaging, high range resolution target signatures and target recognition, classification and identification functions.

(2) Modern Radar Types

There are many modern radar types with some of the more prominent ones being:

Synthetic Aperture Radar (SAR) is a coherent pulsed radar which increases the effective cross-range resolution of the radar by signal processing the radar returns received from various aspect angles and associated doppler frequencies. This radar takes advantage of the motion of the radar platform to synthesize a long effective antenna aperture. SAR imagery is produced by coherently processing reflected target echoes over the length of the synthetic antenna.

Inverse Synthetic Aperture (ISAR) is similar to the SAR radar. In the ISAR radar, an image is produced by target rotational motion as opposed to radar platform motion in SAR radar. ISAR radars are generally used to image individual targets or relatively small target areas. High resolution radar images can be produced for target recognition, classification and identification.

High Range Resolution and Stepped Frequency Radars employ single pulse waveform coding and multipulse coded parameter variations to obtain high range resolution target signatures. These signatures can be used for target recognition, classification and identification purposes. Low Probability of Intercept (LPI) radar is specifically designed to reduce the probability of enemy counter detection. LPI radar waveforms may include phase coding, frequency coding and other spread spectrum techniques.

Phased Array Radar employs an antenna array whose beam is electronically steered in azimuth and elevation by controlling the relative phase of the signal applied to the individual transmitting antenna elements. This radar is invaluable in a multi-target environment which requires a rapid update of target information.

(3) Modern Radar Description

A simplified functional block diagram of a modern radar is shown in *Figure 2*. The transmitter is now represented by a signal generator block. The modern receiver is greatly enhanced with the addition of a digital signal processor and a digital data processor. Radar waveform selection and advanced digital signal processing can take advantage of the coherent properties of modern radars to perform high resolution target parameter measurements and high range and cross-range resolution target imaging. Also, multi-mode radar systems can be readily configured with these modern digital radar systems.

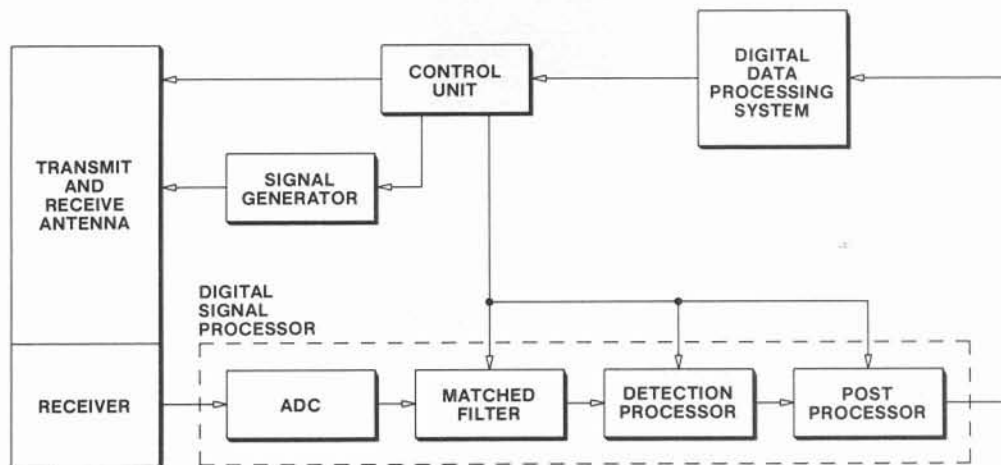

Figure 2. Modern Radar Block Diagram

III. RADAR SYSTEM CHARACTERIZATION

A. INTRODUCTION

Radar was earlier characterized as “extending one’s sensory horizon,” with respect to distance. For many military applications, radars are uniquely qualified to detect, locate monitor, identify and track distant targets. The specific operational requirements are different for each application. consequently, each radar system must be designed to meet the specialized requirements of the particular scenario environment. *Figure 3* illustrates conceptually the process of transposing tactical operational requirements into an operational radar system.

Two major analysis sequences are involved in the process as depicted in *Figure 3*, tactical-to-technical conversion (*blocks 7-1*) and technical-to-tactical conversion (*blocks 8-15*). Tactical-to-technical conversion sequency is used to convert operational requirements to technical performance requirements. User’s operational needs are translated into technical requirements, i.e. minimum and maximum detection range, probability of detection, probability of false alarm, number of target tracks, etc.

Analysis based upon the stated tactical operational requirements are performed with respect to specific mission, platform, and radar scenarios. The tactical-to-technical conversion analysis yields the quantitative technical performance requirements specification.

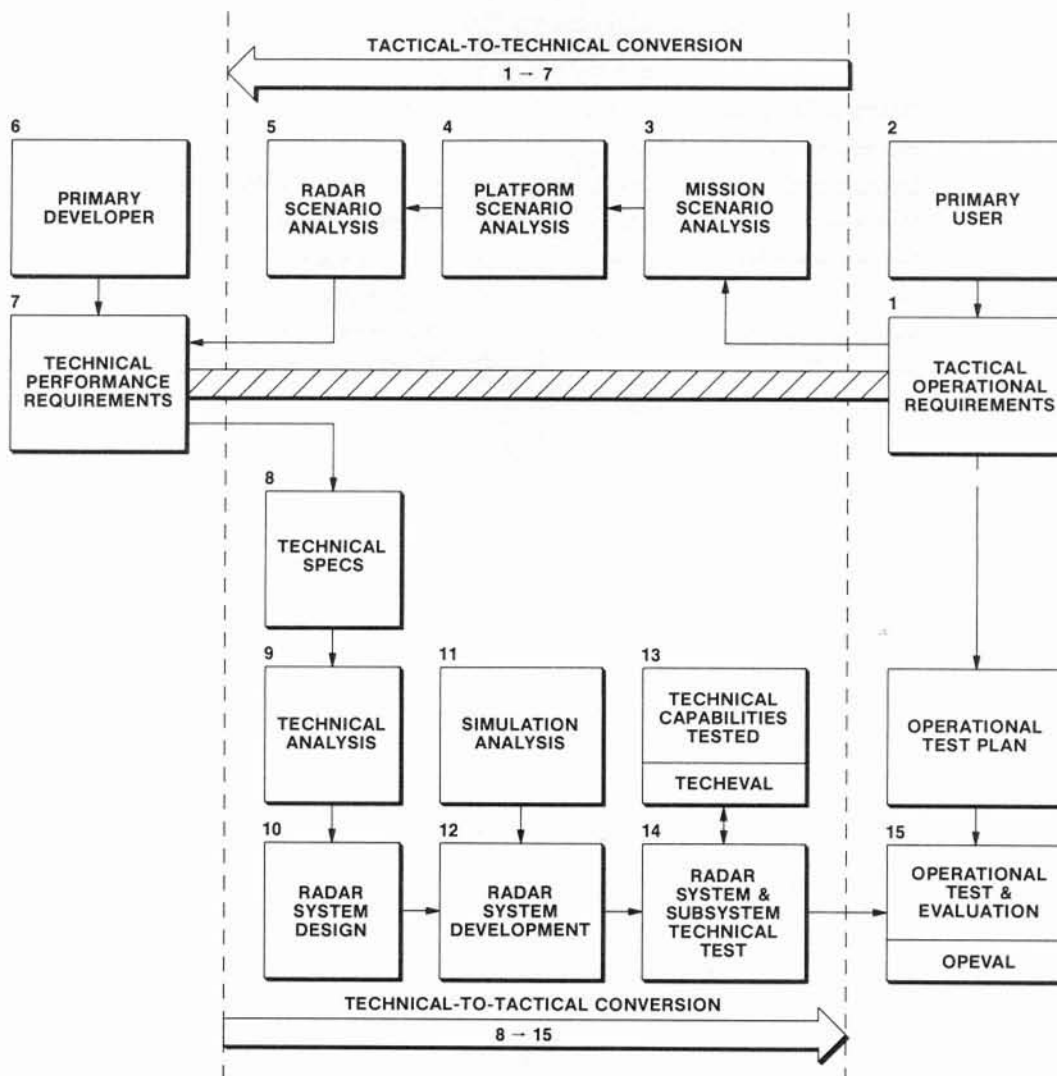

Figure 3. Radar Systems Engineering

The technical-to-tactical conversion is the transformation of technical performance requirements into an operational radar system, which is designed to meet the tactical operational requirements of the primary user. Technical specifications, technical analysis, system design, and radar systems development are the steps involved in this conversion sequence. Radar testing is an important part of this sequence and is performed at three levels: (1) developmental, (2) technical, and (3) operational.

B. RADAR TEST AND EVALUATION

Developmental testing is concerned with the evaluation of component performance and circuit design characteristics.

Technical testing is concerned with performance evaluation of radar system and subsystems. The principal method of technical evaluation is the quantitative measurement of each subsystem and full system technical characteristics.

Operational testing is concerned with the evaluation of the final radar system design and production implementation. Primary interest in radar testing is the ability of the system to accomplish its intended tactical operational requirements.

Table 1 contains a list of some of radar parameters tested during operational test and evaluation.

Table 1. Operational Test Parameters

| | |
|----------------------------|--------------------------|
| Antenna Beamwidth | Antenna Boresight |
| Bearing Accuracy | Bearing Resolution |
| Detection Range (Min/Max) | Probability of Detection |
| Probability of False Alarm | Range Accuracy |
| Range Resolution | Field of View |
| Scan Rate | Scan Pattern |
| Velocity Accuracy | Acquisition Time |
| Velocity Resolution | Track Velocity (Min/Max) |
| Tracking Range (Min/Max) | |

C. TECHNICAL TESTING

Technical testing is described for three major radar subsystems: transmitter, receiver, and signal processor. (See Figure 2.) These radar tests are generically characterized and functionally described with many test implementation details omitted for ease of understanding. Test implementation details are provided in the radar test results section of this application note.

Simplified functional test diagrams are shown in Figures 4, 5, and 6 for the transmitter, receiver, and signal processor, respectively.

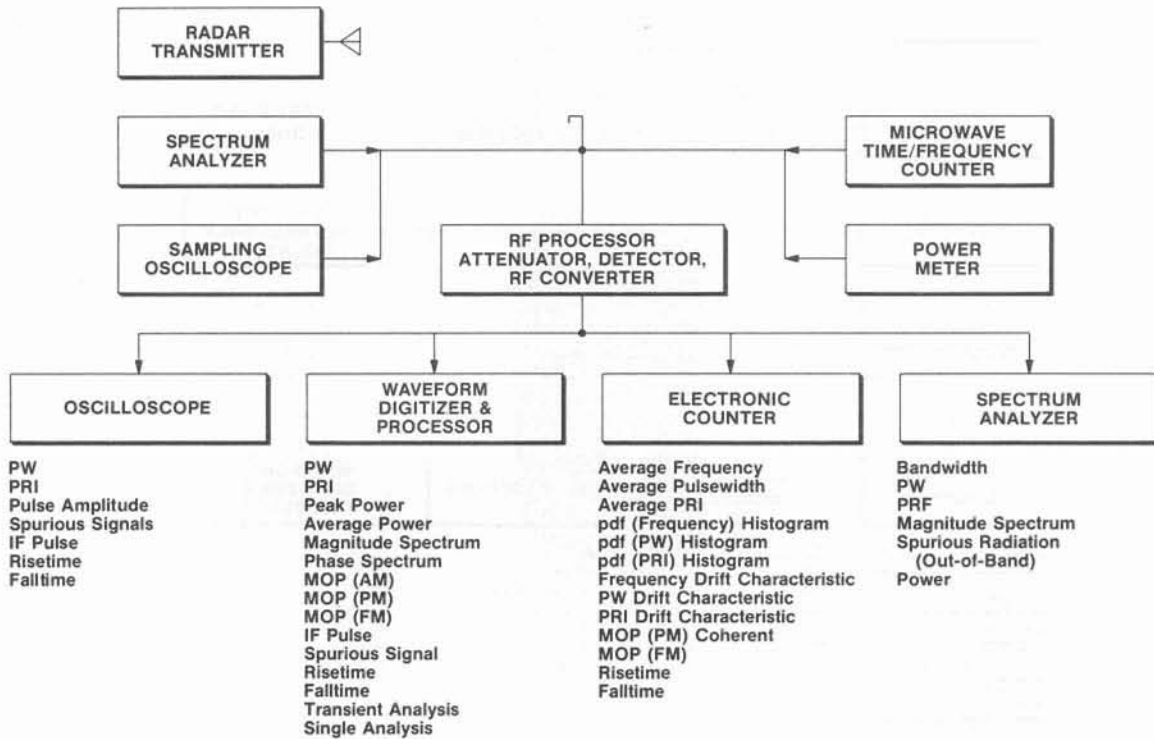

Figure 4. Transmitter Simplified Functional Test Diagram

The transmitter's test diagram illustrates how to sample, attenuate, distribute, detect, measure, capture and display those parameters and signatures associated with the radar transmitter's technical evaluation. The RF signal is first sampled using a directional coupler. The signal is then passed through an RF processor for selective conversion, attenuation, detection, and distribution. Selected signals are transferred to the test equipment in a form appropriate for measurement.

The receiver's simplified test diagram (Figure 5) illustrates how to use ideal target reflected or generated signal waveforms to measure selected radar receiver parameters and signatures. The RF processor is used to provide the appropriate interface between the radar receiver and commercial test equipment.

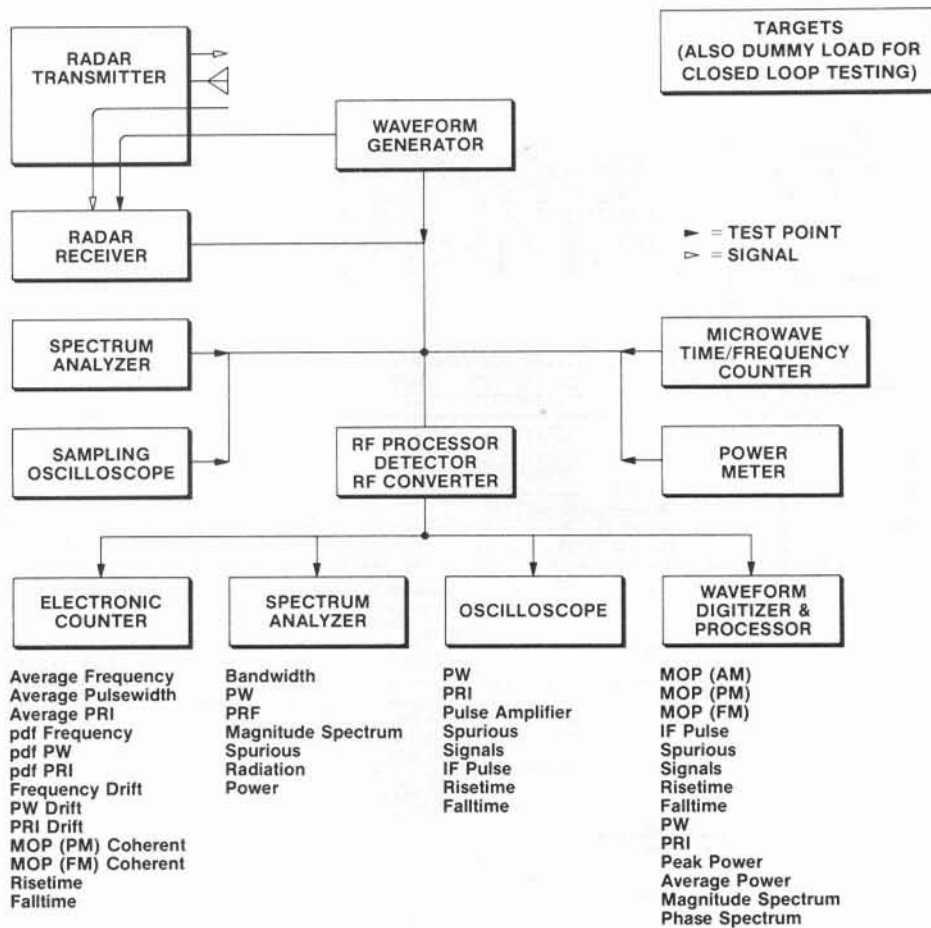

Figure 5. Receiver Simplified Functional Test Diagram

The signal processor's simplified test diagram (Figure 6) illustrates the signal distribution, measurement equipment, and measurement parameters and signatures considered in the technical testing of a radar signal processor. Technical testing is performed on IF signals, digital signals and signal processing circuits or algorithms.

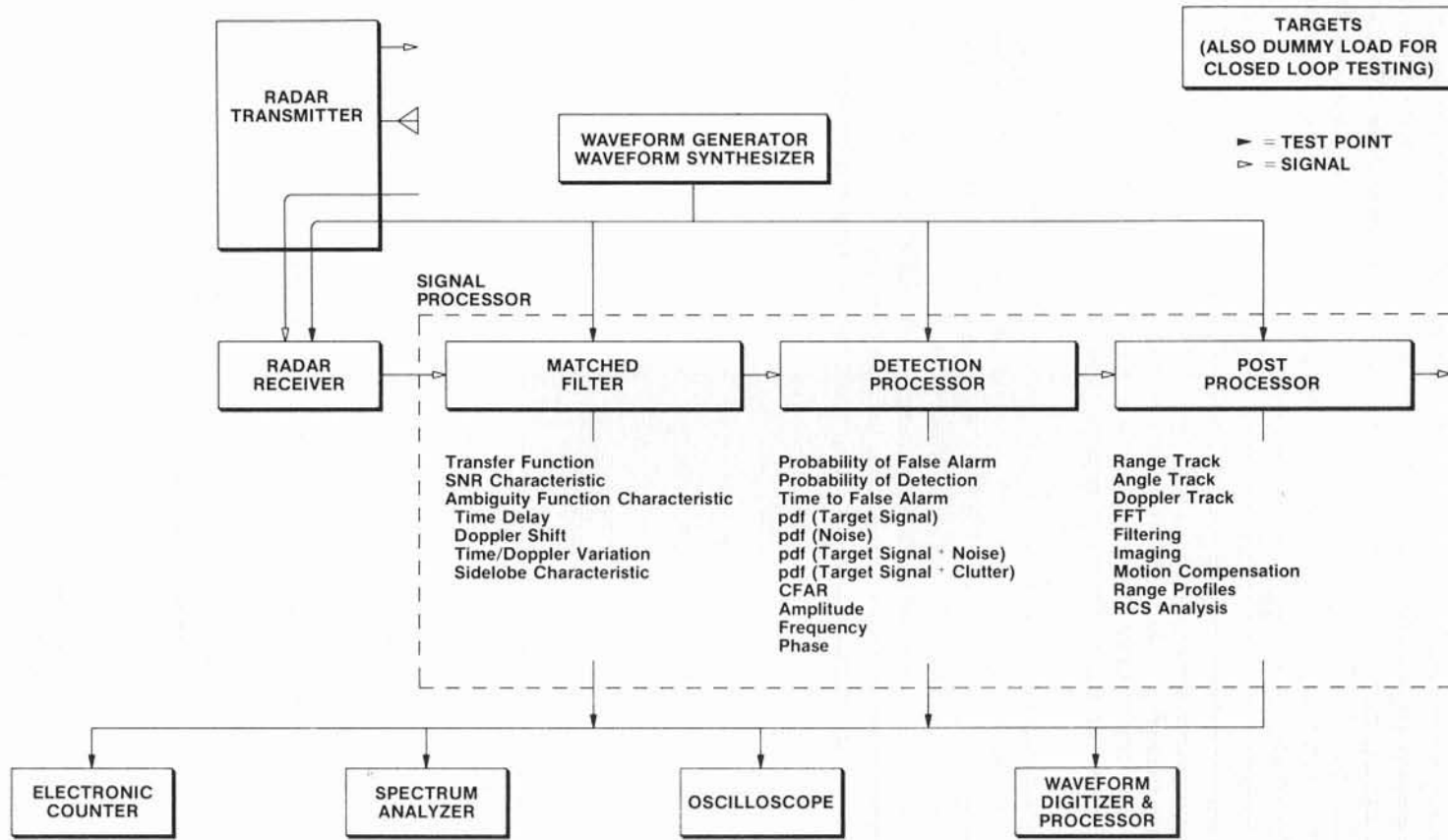

Figure 6. Signal Processor Simplified Functional Test Diagram

The final consideration in the technical evaluation of radar subsystems is the selection of test equipment. Selection of high performance test instruments lets the true characteristics of the radar be captured and quantified. The transmitter simplified functional test diagram (*Figure 4*) reveals PW, PRI, pulse amplitude, risetime, and falltime can be measured using a number of test instruments including a frequency counter, spectrum analyzer, oscilloscope, or a waveform digitizer with signal processor.

The oscilloscope is well suited for the measurement and display of repetitive signals and visual analysis of radar parameters and signatures. The new digital waveform recorder can measure repetitive signals and also measure transient signals and analyze single radar pulse characteristics. The recorder is capable of yielding fine grain quantitative technical parameters and signatures, data storage for future analysis, additional built-in digital signal processing analysis, and user-friendly plotting routines for signature and processing results presentations.

Waveform generators and waveform synthesizers are shown in *Figures 5 and 6*. These test instruments are used to simulate and replicate radar target return signals, which are important for valid and repeated technical testing of radar receiver and radar signal processing subsystems.

The spectrum analyzer is a useful test instrument for radar system evaluations. The spectrum analyzer is used to determine radar signals power spectrum, signal bandwidth, power, spurious radiation and other characteristics. The power meter is used to measure peak and average power levels of radar signals.

Electronic Counters are well suited for precision time interval and frequency measurements. Radar waveform parameters are measured in the time and frequency domains, hence the Electronic Counter is *definitely an important piece of radar test equipment*. The Electronic Counter is used to measure parameters at microwave, IF, and video frequencies.

This application note is centered on demonstrating the HP 5345A Electronic Counter performance capabilities for solution of some radar test and characterization problems. Radar transmitter parameters and signatures are captured, analyzed and presented for several operational radars.

IV. HP 5345 ELECTRONIC COUNTER

The reciprocal (time) counting technique of the HP 5345A Electronic Counter provides for flexible frequency and time interval measurements. Typically, counters work best in situations where events are non-repetitive, speed is important or accuracy and resolution are required. Time is one of the most precisely defined fundamental units of measure. Frequency, the number of events per unit of time, establishes accuracy from this fundamental relationship.

Precision time interval measurements using an electronic counter, enable one to accurately measure the elapsed time between some designated "start and stop" phenomena.

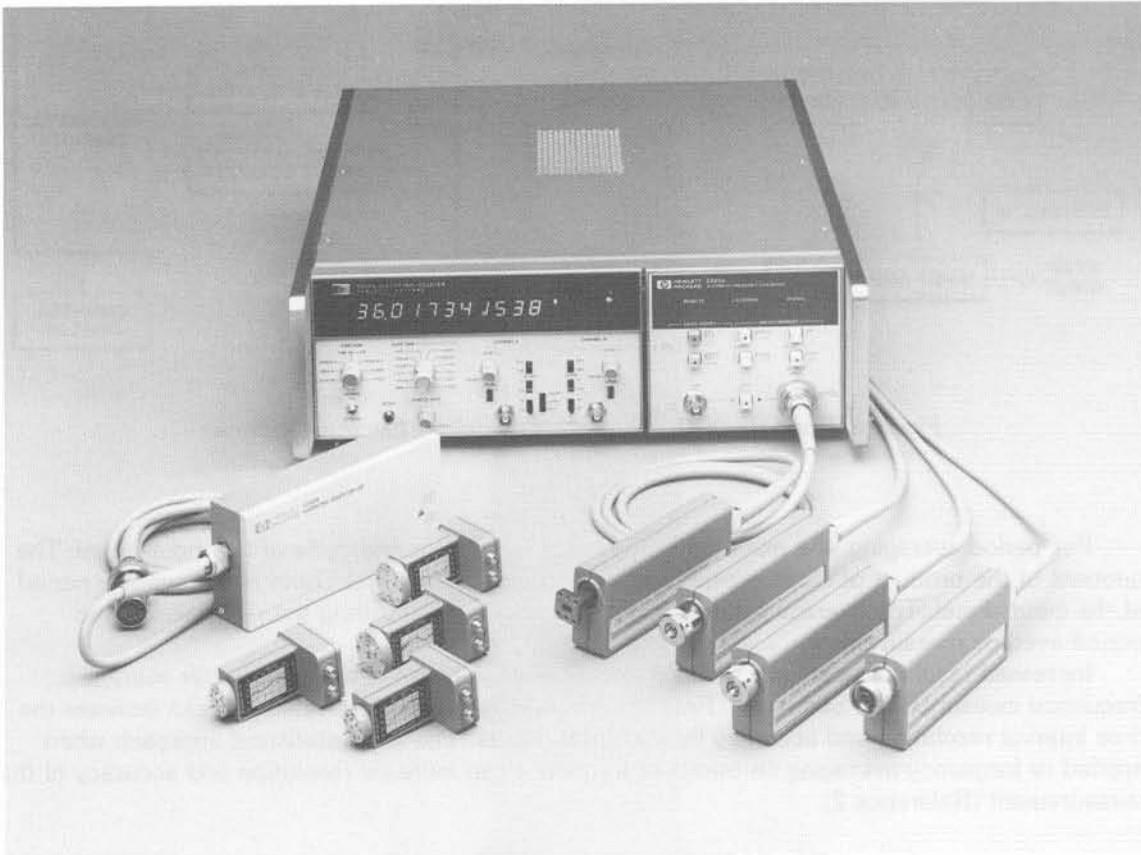

Figure 7. HP 5345A, 5355A, 5356A/B/C/D Electronic Counter

The basic block diagram of the HP 5345A counter is shown in (Figure 8). The EVENT counter accumulates counts from the input signal while at the same time, the TIME counter accumulates counts from the internal clock for as long as the main gate is open. For a single period measurement, the main gate opens for precisely one period under control of the input signal. During the period, the EVENT counter accumulates one count while the TIME counter accumulates a number of clock pulses. The number of clock pulses is then multiplied by the clock period to give the period of the input signal.

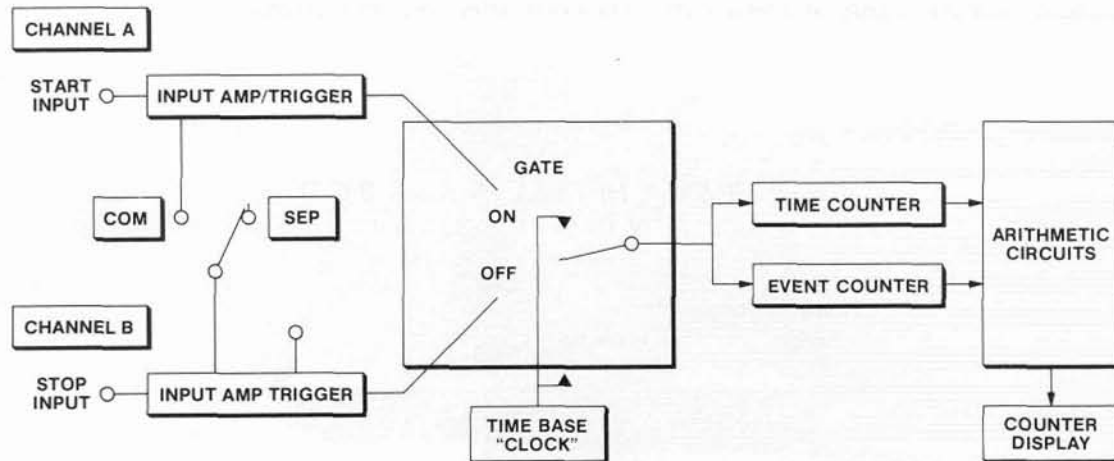

Figure 8. Basic Block Diagram of an HP 5345A Electronic Counter

For period averaging, the main gate is open for more than one cycle of the input signal. The quotient of the product of clock period and clock count to the event count is the average period of the input signal. The average frequency is determined by calculating the reciprocal of the period average measurement.

Increased resolution obtained through period averaging also results in a better average frequency measurement. Similarly, Time interval averaging of repetitive signals can increase the time interval resolution and accuracy by statistical means. The same statistical approach when applied to frequency averaging on bursts of frequency can increase resolution and accuracy of the measurement (Reference 2).

A. TECHNICAL PERFORMANCE SPECIFICATIONS

The HP electronic counter consists of two main sections; a low frequency direct counter section (HP 5345A), and a down conversion section (HP 5355A) which translates the microwave signal down to the frequency range of the low frequency counter. A selected frequency converter head (HP 5356A/B/C/D) further extends the frequency range to 110 GHz. This equipment fulfills requirements for the direct measurement of pulse modulated and CW signals from DC to 110 GHz.

The HP 5345A Electronic Counter provides 500 MHz direct count frequency range, 2 nsec single-shot time interval resolution, and a variety of converter heads for extended frequency capability. The HP 5355A "Automatic frequency converter" provides down conversion of the input microwave signal to the frequency range of the HP 5345A. (Reference 3). Table 2 contains a summary of technical performance characteristics for the HP 5345A, 5355A, 5356A/B/C/D.

*Table 2. HP 5345A, HP 5355A, HP 5356A/B/C/D —
Summary of Technical Specifications*

Time Interval/Time Interval Average

Range: 10 ns to 20,000 s
Trigger Pulse Width: 1 ns minimum
Resolution: 2 ns to 2 ps

CW/Pulse Performance

DC to 110 GHz
-25 dBm Sensitivity
1 Hz Resolution in 1 Second
80 MHz FM Tolerance
Pulse Width: 75 ns minimum
Automatic Amplitude Discrimination
Resolution Selectable to 100 Hz
Accuracy to 3 KHz on pulse signals
External Gating
Automatic Acquisition
Automatic Calibration (Pulsed Mode)
User Definable Offset Entered From Keyboard

A distinct advantage of the above electronic instrument combination, i.e. the HP 5345A, 5355A, 5356A/B/C/D, is that it combines the performance characteristics of three different instruments into one: CW MICROWAVE COUNTER — which makes CW measurements from DC to 110 GHz with performance equal or greater to that of dedicated counters; PULSE MICROWAVE COUNTER — which automatically measures, without auxiliary equipment, the average frequency of pulse modulated signals more accurately and with greater ease than all other techniques; UNIVERSAL TIME INTERVAL COUNTER — which provides the time interval measurement capability equal to the best universal counters for critical timing measurements.

B. RADAR SIGNAL MEASUREMENTS

A specific radar application of an electronic counter is the measurement of radar waveform parameters. A single electronic counter can be configured to measure: average RF carrier frequency; STALO (stable local oscillator) frequency; COHO (coherent oscillator) frequency; pulsewidth (PW); pulse risetime/falltime; pulse repetition interval (PRI); pulse repetition period (PRP); and pulse repetition frequency (PRF). The test equipment block diagram shown in Figure 9 illustrates a typical measurement setup. The directional coupler, normally at the output of the radar power amplifier, provides a low power sample of the transmitted signal. Proper attenuation and down conversion via the appropriate down converter head (HP 5356A/B/C/D) is normally required.

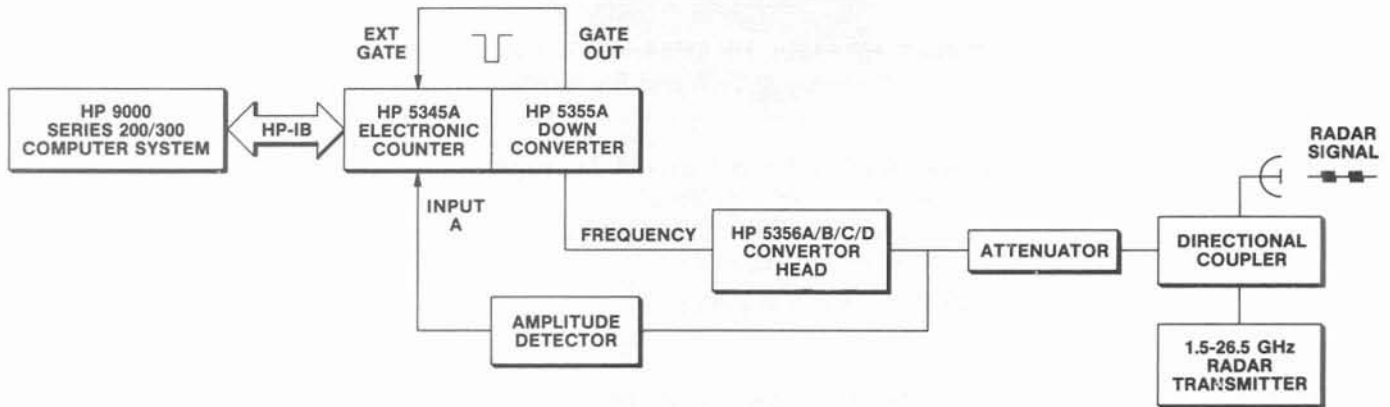

Figure 9. Block Diagram of Equipment Setup for Making Radar Frequency and Time Interval Measurements

For frequency measurement, a properly applied signal will cause the HP 5355A to automatically generate a gating signal which in turn gates the HP 5345A mainframe "on" while the signal is present. For pulsed signals below 1.5 GHz, the HP 5356 converter head is not required and the signal is fed directly to the prescaler input of the HP 5355A. For time interval measurements such as PW, PRF and PRI, the signal is passed through a detector and applied directly to the HP 5345A Electronic Counter.

The HP 5345A Electronic Counter may be used independently or teamed with a high performance computer such as a HP 9000 Series 200/300. The HP 9000 series 200/300 computer and HP 5345A Electronic Counter combination provides enhanced collection capabilities and data storage. Software analysis programs are available for generating data point plots, probability density function histograms and computing statistical results.

The average frequency profile of a pulsed radar can be measured using the HP 5345A, 5355A, 5356A/B/C/D Electronic Counter equipment, an associated HP 5359A Timing Synthesizer and an HP 8013B Pulse Generator. The measurement system test setup is illustrated in Figure 10 for the average frequency profile signature of a generic RF pulse. The external gate, provided by the HP 5359A to the HP 5345A Electronic Counter, may be as narrow as 20 nsec. After each measurement, the delay between the external trigger to the HP 5359A and its output pulse is time incremented such that the measurement window is "walked" through the RF pulse signal. A high resolution average frequency profile signature is measured by the test system. (Reference 4).

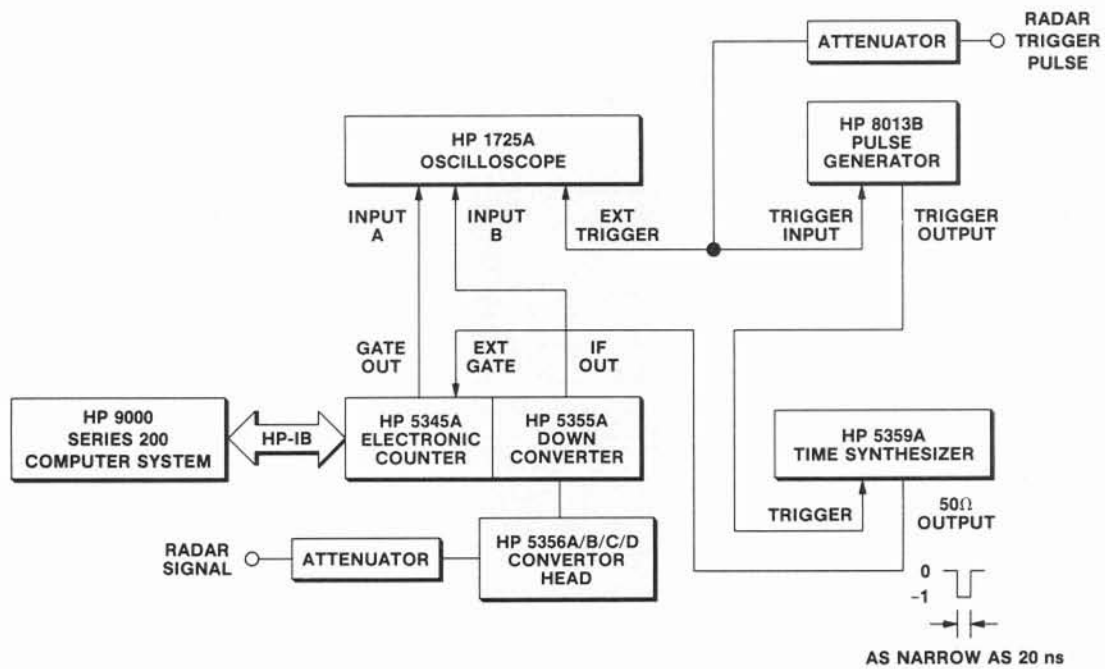

Figure 10. Block Diagram of Equipment Setup for Making Radar Waveform Average Frequency Profile Measurements

V. RADAR TEST RESULTS

A. INTRODUCTION

Actual radar tests are performed and measurement results and signal processing results are presented in this section. These radar transmitter tests and test results demonstrate some of the basic capabilities of the HP 5345A Electronic Counter and associated signal processing on the HP 200 Series Computer. Three U.S. Navy operational radar systems are tested: the AN/SPS-10E, a surface search and navigation radar; the AN/SPS-40A, a long range air search radar; and the AN/SPS-65(V)1, a modern air search radar.

Radar data collection tests are a cooperative effort between SigPro Systems Inc. — planning, coordination, test program and technical testing; Hewlett Packard — test equipment, technical testing and support; and the U.S. Naval Postgraduate School — radars, facilities and radar support personnel.

Specific radar transmitter parameters such as frequency, pulsewidth, PRP, PRF and pulse risetime/falltime are measured, signal processed and analyzed. Average frequency profile data is also collected and presented. Signal processing results are presented in data point plots, histograms and statistical analysis results.

B. AN/SPS-10E RADAR SYSTEM

1. Radar Technical Characteristics

The AN/SPS-10E is a C-band surface search and navigation radar, with an additional limited capability against submarine periscopes and low flying aircraft. It was introduced into the U.S. Navy in the early 1950's and is currently utilized on Naval combatants and large non-combatants.

The radar transmitter's magnetron generates a peak power of approximately 200 kilowatts at an RF frequency of approximately 5.5 GHz. Two radar pulsewidths (0.25 microseconds and 1.3 microseconds) are available on a manual selection basis. The radar is equipped with a cosecant squared antenna and provides range and bearing information on a plan position indicator (PPI) display.

A block diagram of the SPS-10E radar system is presented in Appendix A, *Figure 67*. Reference 5 contains a detailed technical description for this radar. SPS-10E radar Technical specifications are summarized in Table 3 (Reference 6). The HP 8569B Spectrum Analyzer is used to generate the power spectra of the transmitter signals presented in *Figures 11 and 12*.

Table 3. SPS-10E Radar — Summary of Technical Specifications

Radar Transmitter Characteristics

| | |
|----------------------------|--------------|
| Peak Power (kW) | 190 – 285 |
| Pulsewidth (μ sec) | 1.3 and 0.25 |
| Pulse Repetition Frequency | 625 – 650 |
| Average Power (W) | 160 |
| Emission Bandwidth (kHz) | 1600 – 8000 |
| Transmitter Type | Magnetron |
| Frequency Range (MHz) | 5450 – 5825 |
| Operating BW (MHz) | 375 |

Radar Receiver Characteristics

| | |
|----------------------------------|-----|
| Minimum Discernible Signal (dBm) | -98 |
| Noise Figure (dB) | 14 |
| IF Frequency (MHz) | 30 |

Radar Antenna Characteristics

| | |
|--------------------------------|---------------------------------------|
| Antenna Type | Parabolic Reflector |
| Antenna Gain (dB) | 30 |
| Polarization | Horizontal |
| Beamwidth (Degrees) | Horizontal: 1.5 Vertical: 12 to 16 |
| Scan Coverage (Degrees) | Horizontal: 360 Vertical: 16 |
| Horizontal Scan Rate (Rev/Min) | 14 – 16 |
| Method of Scan | Horizontal – Mechanical |

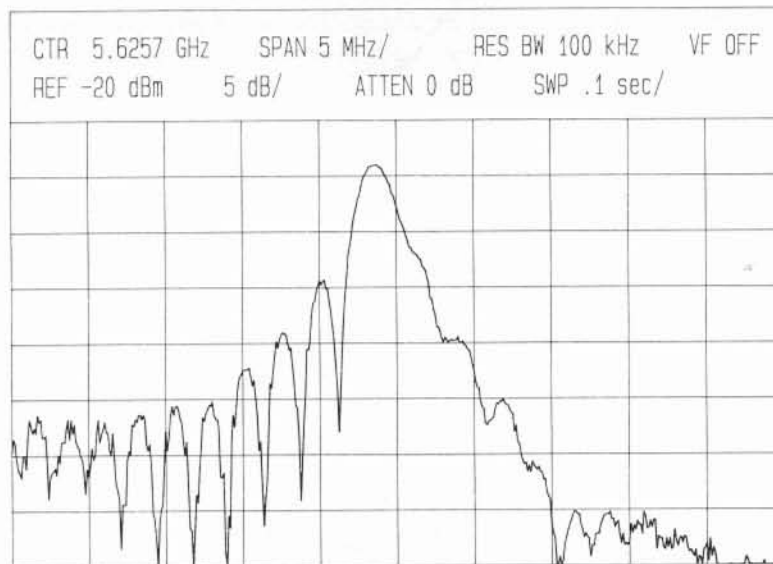

Figure 11. SPS-10E Transmitter Pulse Power Spectrum (Short Pulsewidth)

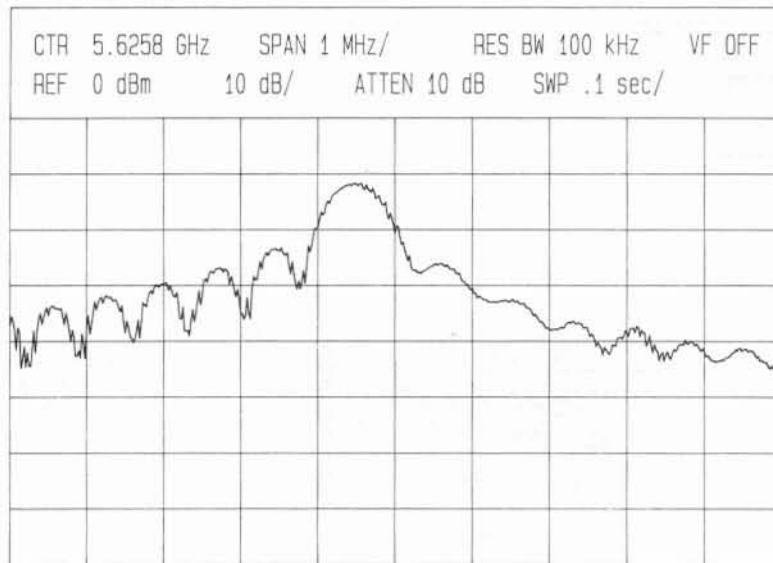

Figure 12. SPS-10E Transmitter Pulse Power Spectrum (Long Pulsewidth)

2. Transmitter Subsystem Test Measurement Configurations

Figures 13 and 14 reveal test setups utilized to collect radar transmitter parameter measurements and the RF pulse's average frequency profile signature, respectively. Electronic Counter test descriptions are summarized in the preceding section of this application note.

a. Radar Waveform Parameter Measurements

Four radar parameter measurements are made on the AN/SPS-10E using the test measurement setup of Figure 13: Frequency, Pulsewidth, Pulse repetition period (PRP), and Pulse repetition frequency (PRF).

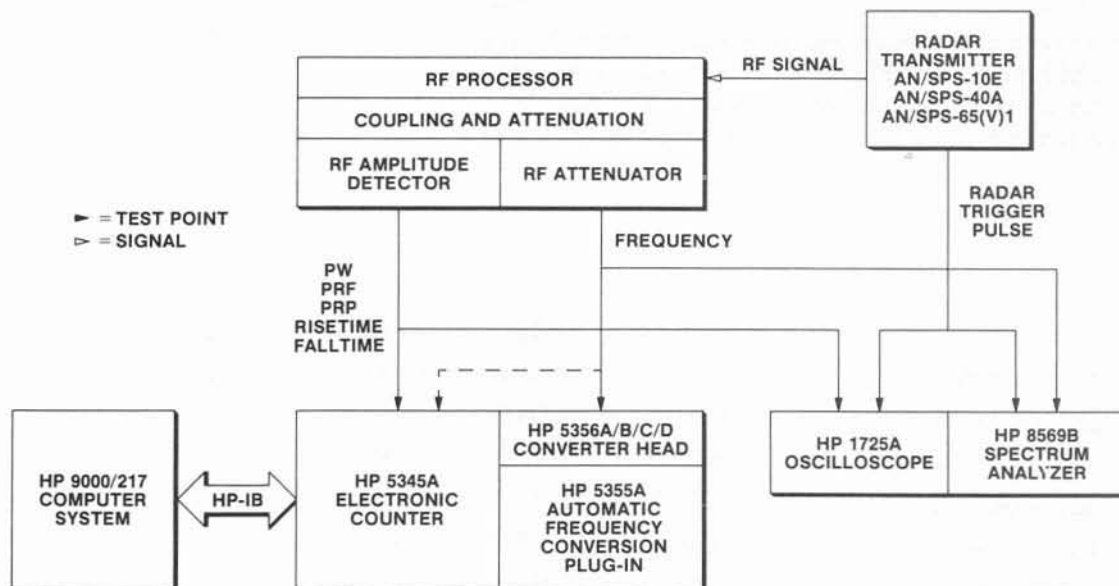

Figure 13. Simplified Block Diagram for Measuring Radar Transmitter Parameters

RF frequency is measured by applying an appropriately attenuated signal to the HP 5345A/HP 5355A and HP 5356A system. Frequency downconversion of the RF input signal is performed by the HP 5355A automatic frequency conversion plug-in unit and the HP 5356A frequency converter head. The HP 5345A Electronic Counter is interfaced with a HP 9000 series 200 computer through the HP-IB interface bus for control, automatic measurement, collection, and data storage.

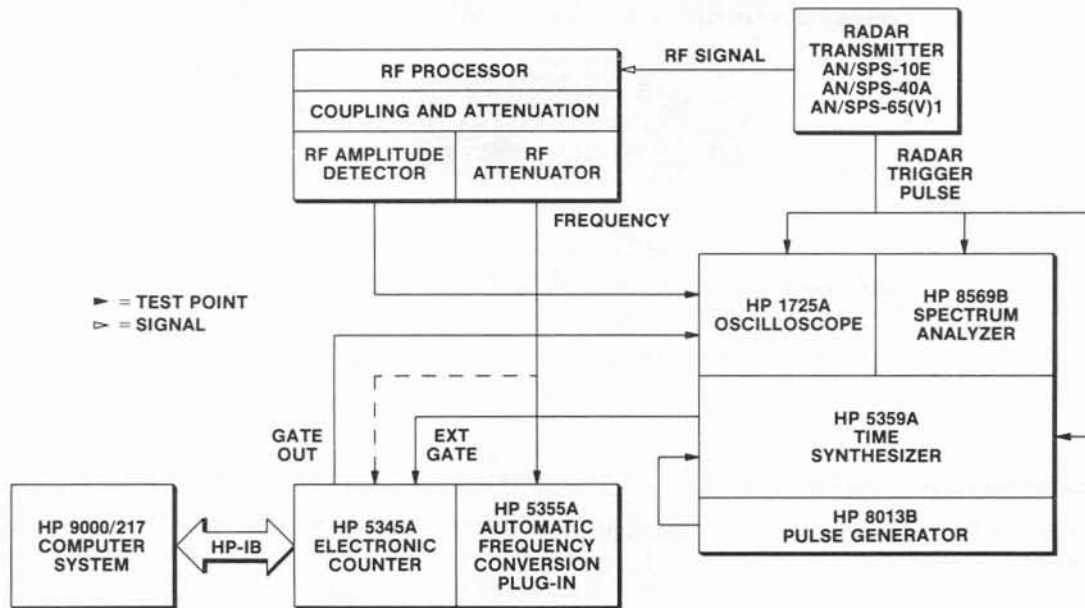

Figure 14. Simplified Block Diagram for Measuring Radar Waveform Average Frequency Profile

PW, PRP and PRF parameters are measured using the output of the RF detector (see Figure 13). The detector output is sent directly to the HP 5345A Electronic Counter. The HP 5345A control settings for measuring these radar parameters are shown in Table 4. The required settings for GATE TIME, SLOPE SWITCH and TRIGGER LEVEL are presented in the test result description for each measured parameter. Photographs of the detected transmitter pulses presented in Figures 15 and 16 are obtained utilizing the HP 1725A oscilloscope.

Table 4. HP 5345A Control Settings

| | PW | PRF | PRP | RT | FT |
|-----------------|--------------|--------------|--------------|-------------|-------------|
| FUNCTION | TI | FREQ A | PERIOD A | TI | TI |
| INPUT IMPEDANCE | 1 M Ω | 1 M Ω | 1 M Ω | 50 Ω | 50 Ω |
| ATTENUATION | X1 | X1 | X1 | * | * |
| SEPARATE/COM | COM A | COM A | COM A | SEP | SEP |
| COUPLING | DC | DC | DC | DC | DC |
| GATE TIME | * | * | * | * | * |

* = GATE TIME, SLOPE SWITCH and TRIGGER LEVEL set as required.

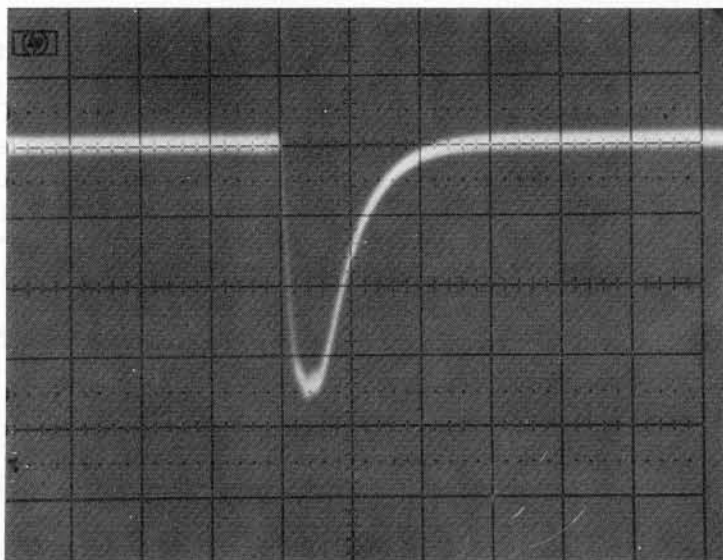

Figure 15. SPS-10E Detected RF Pulse (Short Pulsewidth)

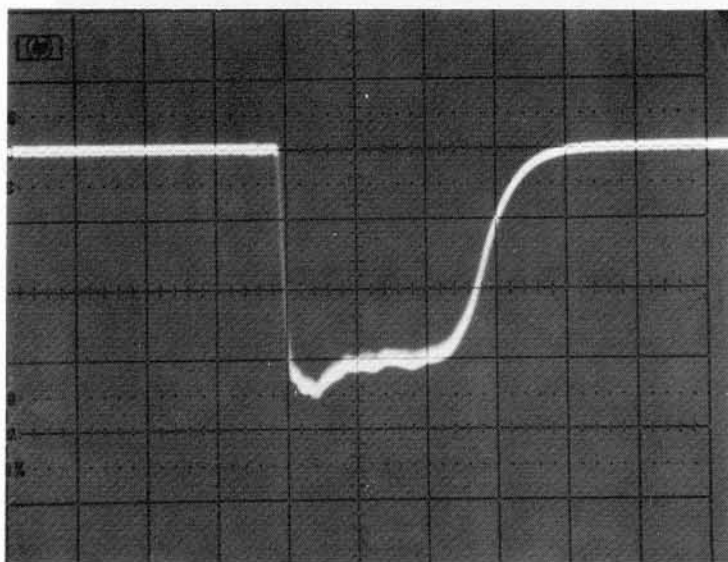

Figure 16. SPS-10E Detected RF Pulse (Long Pulsewidth)

b. Radar Waveform Average Frequency Profile

Radar waveform average frequency profile signature measurements are made using the radar waveform average frequency profile test measurement setup shown in *Figure 14*. The average frequency profile measurements require two pieces of additional test equipment; the HP 5359A time synthesizer, and HP 8013B pulse generator. The TRIGGER output of the HP 8013B pulse generator is used to trigger the HP 5359A unit. The HP 5359A's delayed output pulse is used to enable the HP 5345A Electronic Counter at a specific time within the RF pulse. The width of the external gate determines how long the HP 5345A's gate is open. The external gate signal may be as narrow as 20 nanoseconds. Frequency averaging over many samples provides high resolution in the average frequency profile measurements. After each measurement, the delay time between the external trigger to the HP 5359A and its output pulse is incremented such that the measurement window is "walked" through the RF pulse. Hewlett Packard AN 291-1 contains a detailed discussion of average frequency profile measurements. *Figure 17* is an example of the process and shows an RF pulse signal (Trace 1) and multiple exposures on the HP 5345A GATE OUT signal (Traces 2,3,4).



Figure 17. The scope photo shows an RF pulse and multiple exposures on the HP 5345A GATE OUT signal. The 20 ns gate is "walked" through the burst in 50 ns steps.

3. TEST RESULTS

The SPS-10E radar transmitter test results are presented in this section. In each case, an HP 9000 series 200 computer is used to remotely control the HP Electronic Counter and associated measurement equipment and store the collected data sets. Data collection and analysis software programs are contained in Appendix B. A data point plot, representative expanded point plots, and probability density function histogram are presented for each radar transmitter parameter measured. The output result plots are generated utilizing the HP 7475A plotter in conjunction with the HP 200 series computer.

a. Frequency/Time Interval Measurements

(1). RADAR FREQUENCY

The radar frequency data collection is performed with the test measurement setup illustrated in *Figure 13*. The attenuated transmitter signal is downconverted utilizing the HP 5356A frequency converter head and the HP 5355A automatic frequency converter. The HP 5345A FUNCTION SELECTOR switch is set to PLUG-IN. The HP 5345A GATE TIME is set to 100 μ s for the frequency measurement.

The frequency data collection effort is dramatically simplified and automatically performed by the computer controlled measurement system (*Figure 13*). Manual data collection would require considerable attention, interaction and time by a skilled technician. These important factors preclude, in most cases, obtaining these detailed radar parameter measurements. One thousand RF frequency data samples or points are measured and stored automatically in the HP 9000/217 over a total collection period of approximately 10 minutes.

The frequency point plot for the SPS-10E radar is presented in *Figure 18*. The point plot reveals an important global look at the parameter data set. Radar frequency (GHz) and sample number are plotted on the Y and X axes respectively. Average frequency (horizontal dashed line), standard deviation and variance are calculated using the statistical analysis program in the HP 9000/217 computer and statistical results are presented.

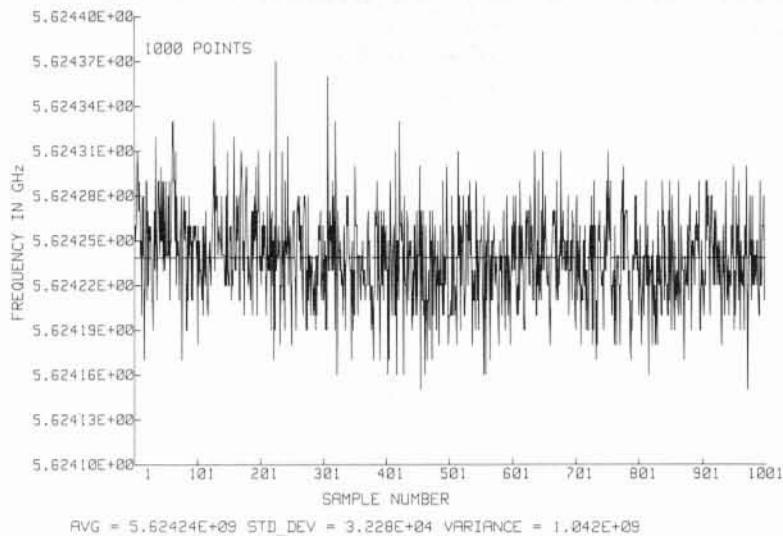

Figure 18. SPS-10 Radar Frequency Point Plot (1000 Points)

An additional feature of the point plot program (Appendix B) is the ability to select a "sample window" for detailed analysis. An expanded view of the frequency point plot is given in Figure 19, where 100 data points are displayed.

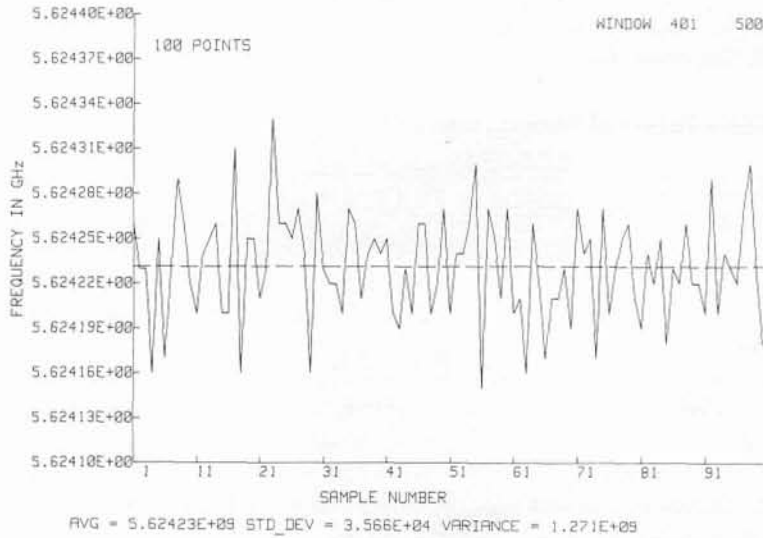

Figure 19. SPS-10 Radar Frequency Point Plot (100 Points)

A software program for producing probability density function (pdf) histograms is available to process the collected parameter data set. The SPS-10E radar frequency pdf histogram is illustrated in Figure 20. This plot is quickly generated utilizing the HP 7475A plotter in conjunction with the HP 9000/217 computer. The number of occurrences and frequency in GHz are plotted on the Y and X axes, respectively.

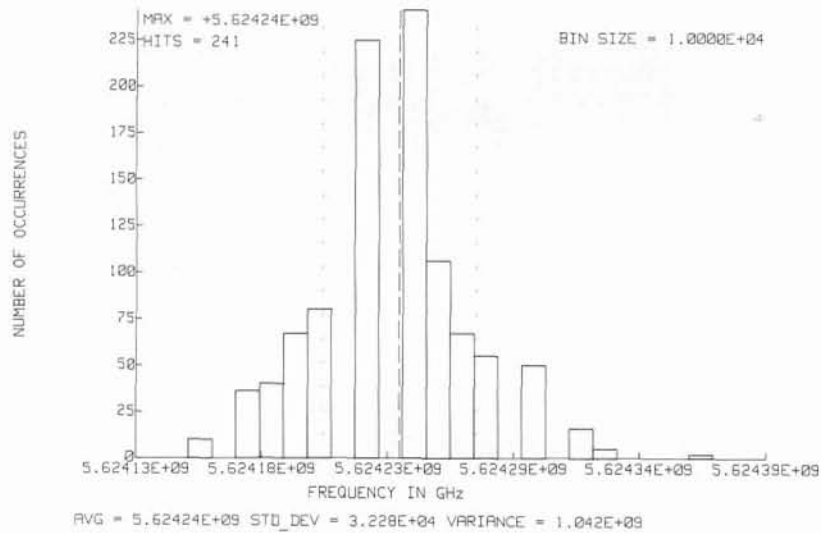

Figure 20. SPS-10 Radar Frequency Histogram

The maximum "number of hits" and the corresponding frequency are included on the pdf histogram plot (241 hits/5.62424 GHz in this case). BIN SIZE is selected as 10 KHz. The average frequency (5.62424 GHz) is indicated numerically, and plotted as a vertical dashed line as well. Standard deviation (32.28 KHz) is indicated numerically, and plotted as two vertically dotted lines - one on either side of the average frequency.

The pdf histogram of the SPS-10E radar's frequency parameter, is approximately a gaussian distribution. This fine grain frequency parameter characterization is a very important part of the radar system technical testing and characterization.

Frequency parameter characteristics are required to ensure radar transmitter operation at assigned frequency, to determine frequency drift, and to characterize ECCM performance capabilities.

(2) RADAR PULSEWIDTH

Radar pulsewidth data collections are made for both short pulse (0.5 microsecond) and long pulse (1.5 microsecond) operations of the AN/SPS-10E radar. The test measurement setup illustrated in *Figure 13* is utilized. HP 5345A control settings are as indicated in *Table 4*. The HP 5345A GATE TIME is set to 100 microseconds, TRIGGER LEVELS are -100 mv and SLOPE is set to +/- . One thousand pulsewidth data points are collected using the digital computer.

The radar pulsewidth point plots for the short pulsewidth and long pulsewidth are illustrated in *Figures 21* and *22*, respectively. Pulsewidth (Y axis) is measured in nanoseconds for the short pulse and in microseconds for the long pulse. Sample numbers are plotted on the X axis. Average pulsewidth, standard deviation and variance are calculated using the statistical analysis program in the HP 9000/217 computer and results are presented. The distribution of the data points about the average appears random in both cases, with the exception of sample window 1 to 201 (short pulse).

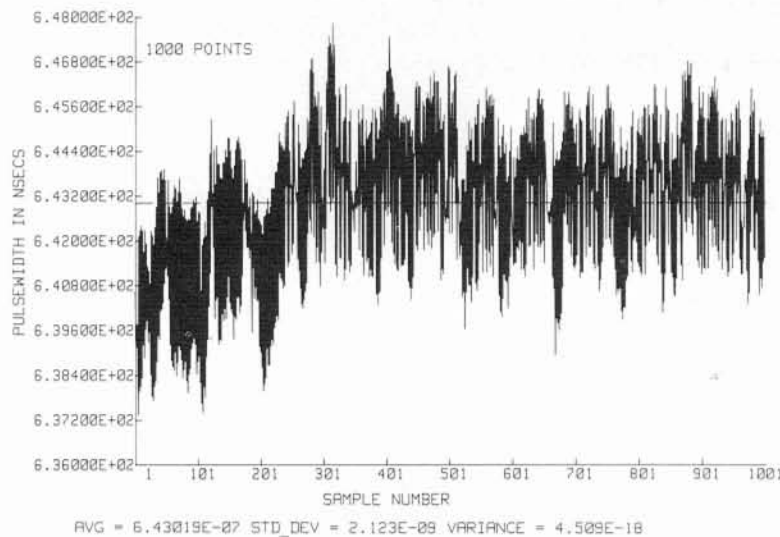

Figure 21. SPS-10 Radar Pulsewidth Point Plot (Short Pulse)

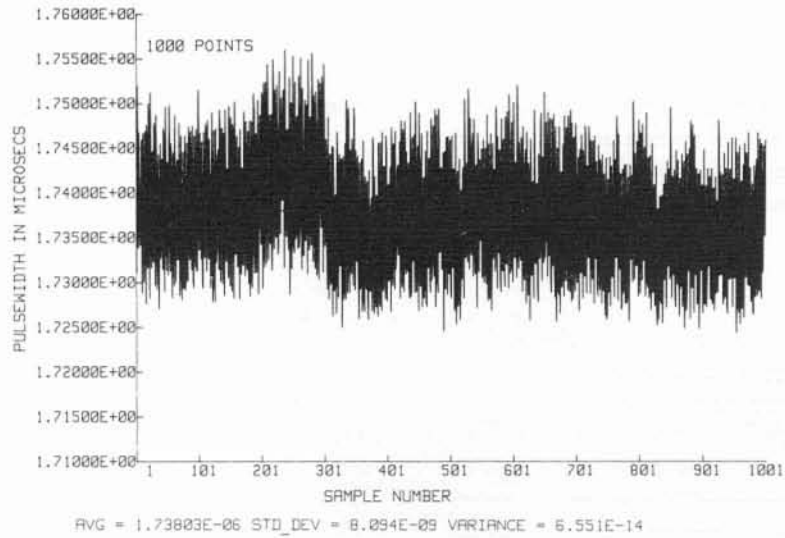

Figure 22. SPS-10 Radar Pulsewidth Point Plot (Long Pulse)

The pdf histogram of the short pulsewidth (Figure 23) is slightly positively skewed. The average value of 0.643019 microseconds is considerably greater than the specified value of 0.5 microseconds (Table 3). Standard deviation is 2.123 nanoseconds. Since PW is directly proportional to radar range resolution, the pdf (PW) characteristic provides a quantitative characterization of actual PW parameters variations on range resolution degradation.

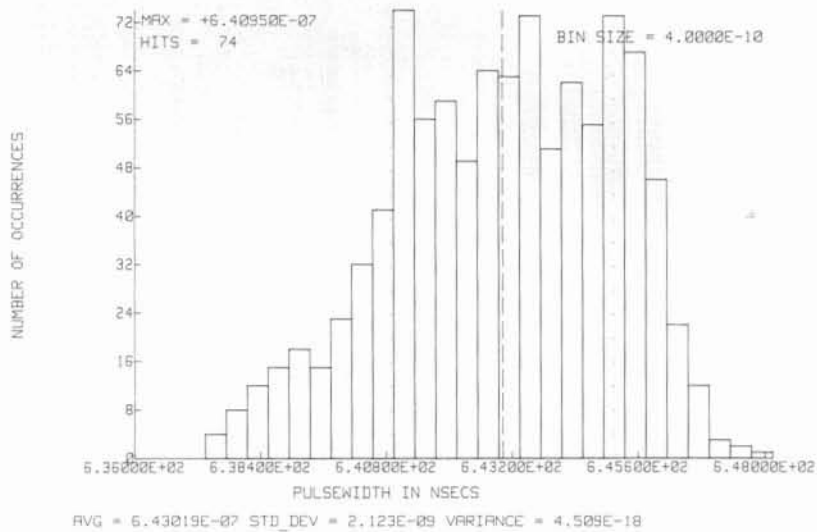

Figure 23. SPS-10 Radar Pulsewidth Histogram (Short Pulse)

The pdf histogram of the long pulsewidth (Figure 24) is distinctly bimodal. The average pulsewidth is 1.73803 microseconds, which is considerably greater than the the specified value of 1.5 microseconds (Table 3). Standard deviation is 8.094 nanoseconds.

This detailed characterization is made easy, convenient and accurate by the automated HP data collection system and digital signal processing software programs.

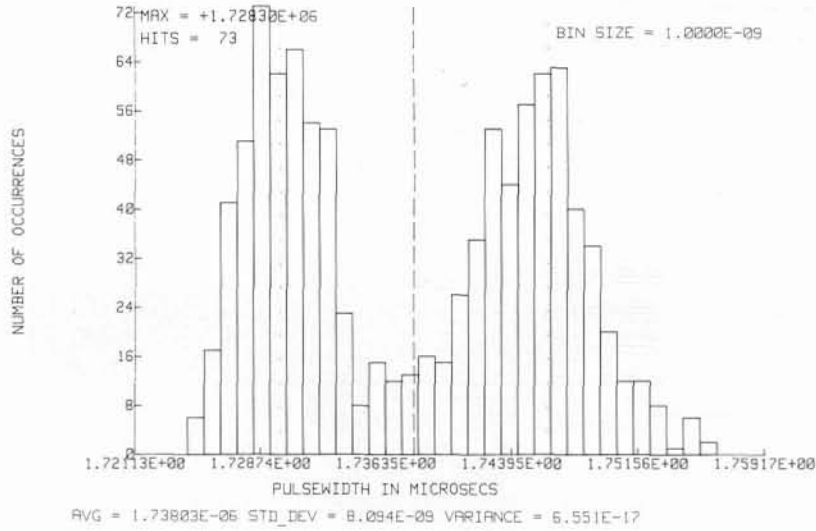

Figure 24. SPS-10 Radar Pulsewidth Histogram (Long Pulse)

(3) RADAR PULSE REPETITION PERIOD.

Radar pulse repetition period data collection is made for short pulsewidth operation of the SPS-10E radar. The test measurement setup illustrated in Figure 13 is utilized. HP 5345A control settings are as indicated in Table 4. The HP 5345A GATE TIME is set to minimum (MIN), i.e., — a single pulse per data point, the TRIGGER LEVELS are set at -100 millivolts and SLOPE is set to -/- . One thousand pulse repetition period data points are collected.

The PRP point plot is shown in Figure 25. The PRP is measured in milliseconds on the vertical axis and sample number on the horizontal axis. An expanded point plot is shown in Figure 26 for samples 402 - 501.

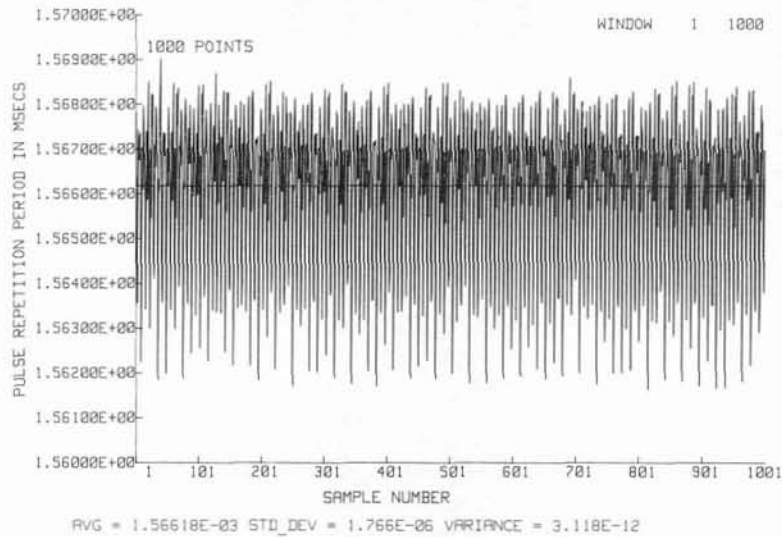

Figure 25. SPS-10 Radar Pulse Repetition Period (1000 Points)

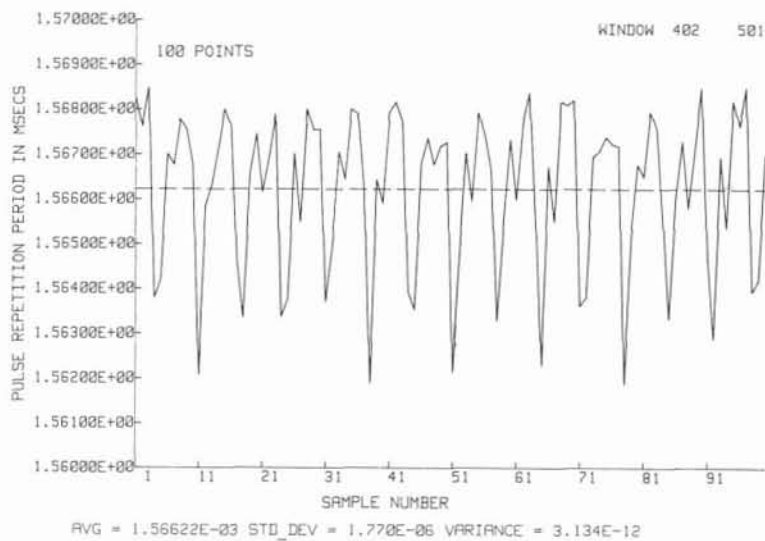

Figure 26. SPS-10 Radar Pulse Repetition Period (100 Points)

The positively skewed pdf histogram of the SPS-10E radar PRP is shown in *Figure 27*. This pdf histogram confirms the high number of “hits” well below the first standard deviation, in this case 1.766 milliseconds. Most “hits” above the average value of PRP are contained within the first standard deviation. The maximum unambiguous range is directly proportional to the PRP. The pdf (PRP) histogram provides a detailed assessment of PRP variation on the radar’s maximum unambiguous characteristic.

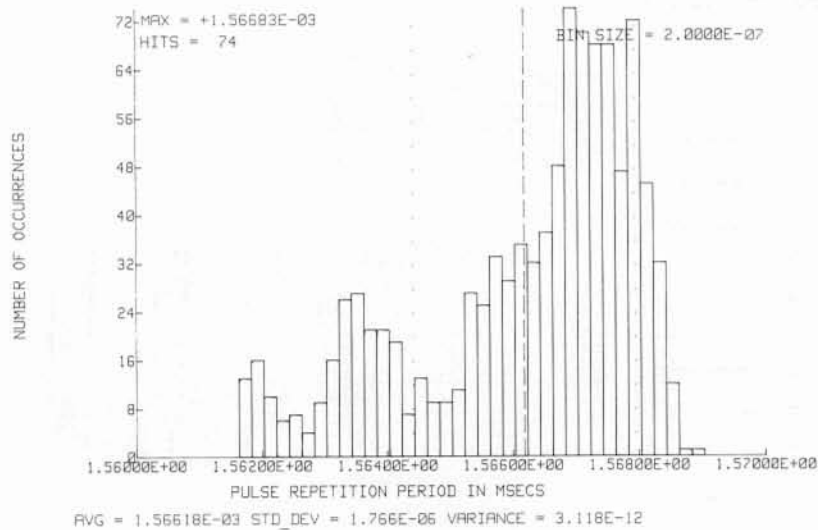

Figure 27. SPS-10 Radar Pulse Repetition Period Histogram

(4) RADAR PULSE REPETITION FREQUENCY

Radar pulse repetition frequency data collection is made for the short pulsewidth operation of the SPS-10E radar. The test measurement setup illustrated in Figure 13 is utilized. HP 5345A control settings are as indicated in Table 4. The HP 5345A GATE TIME is set for minimum (MIN) and the TRIGGER LEVELS are set at -100 millivolts. One thousand PRF data samples are collected.

The radar pulse repetition frequency point plot is shown in Figure 28. The PRF is plotted on the Y axis and measured in Hz. Sample number is plotted on the X axis. Positive aberrations from the average PRF value of 638.489 Hz are much greater than negative ones.

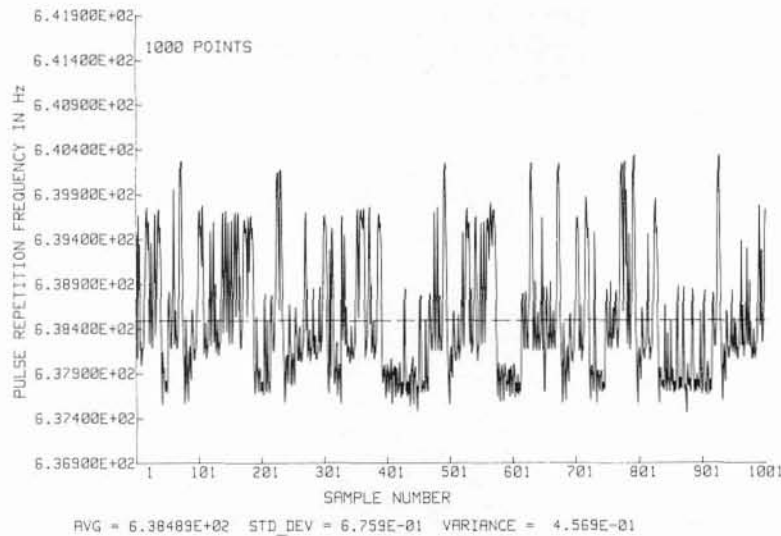

Figure 28. SPS-10 Radar Pulse Repetition Frequency

The negatively skewed pdf histogram of the radar PRF is shown in Figure 29. This pdf histogram is similar to a mirror image of PRP histogram (Figure 25). The PRF results are tied very closely to the PRP results presented earlier, since the PRF is the reciprocal of PRP. The average PRF value is 638.489 Hz which is approximately halfway between the specified values of 625 - 650 (Table 3).

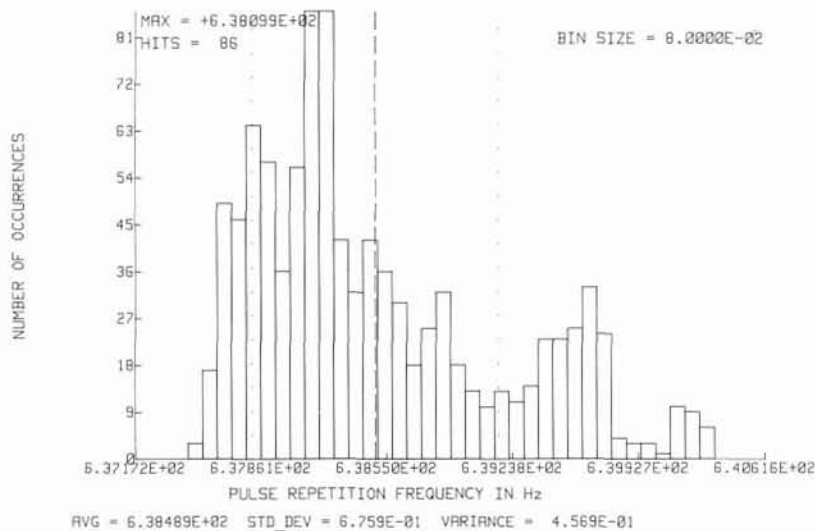

Figure 29. SPS-10 Radar Pulse Repetition Frequency Histogram

b. Average Frequency Profile Signature Measurements

The radar average frequency profile signature data collections are made using the test measurement setup illustrated in *Figure 14*. The attenuated radar transmitter signal is downconverted utilizing the HP 5365A frequency converter head and the HP 5355A automatic frequency converter plug-in. A radar trigger pulse is used to externally trigger test measurement equipment. The detailed average frequency profile signature provides information on some ECCM features of the radar and reveals unwanted frequency modulation.

Frequency profile data collection sets are obtained for both short pulsewidth and long pulsewidth operation of the SPS-10E radar using the automated system. Manual data collection and analysis is inconceivable for the frequency profile data sets. The Electronic Counter and HP 9000/217 computer automatically samples, collects and stores the radar frequency profile signature data points in about 20 minutes for short pulsewidth operation of the SPS-10E radar. Frequency profile collection time is approximately 45 minutes for the long pulsewidth mode. A STEP SIZE of 5 nsec is used for the collection of both radar frequency profile data sets.

The SPS-10E radar average frequency profile point plot for short pulsewidth and long pulsewidth operations are illustrated in *Figures 30, 31*, respectively. Window samples selected for signature presentation are 17-92 and 25-275 for short pulsewidth and long pulsewidth operations, respectively. These window selections adequately display the complete average frequency profile signature.

The radar average frequency profile signature for the short pulsewidth operation is rather unique. The front edge characteristic contains an upward pulse frequency swing. The center section of the RF pulse is relatively constant, while the trailing edge of the characteristic has a downward frequency swing. Radar system capabilities against EW systems may be partially determined by detailed characterization of the frequency profile signature.

The radar frequency profile signature for long pulsewidth operation of the SPS-10E is much more random with only a few large excursions from the average frequency. The frequency characteristic is above the average frequency for the front edge of the pulse. Also, the frequency swing is downward at the trailing edge of the pulse.

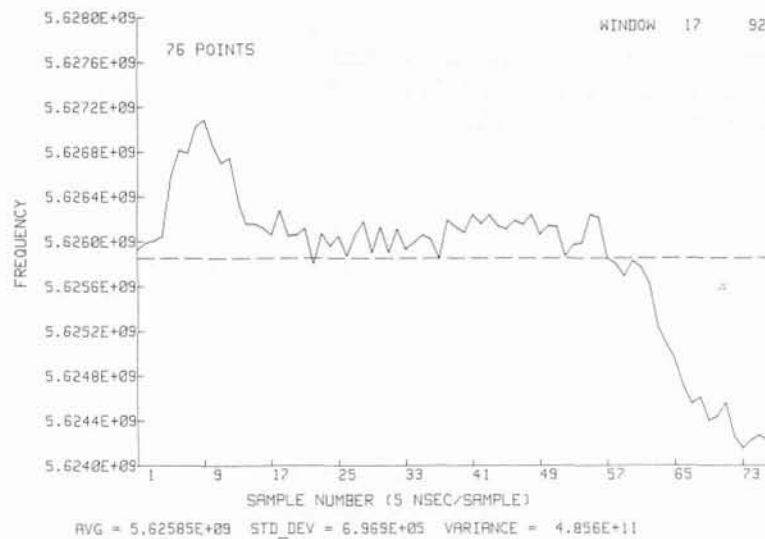

Figure 30. SPS-10 Radar Frequency Profile (Short Pulse)

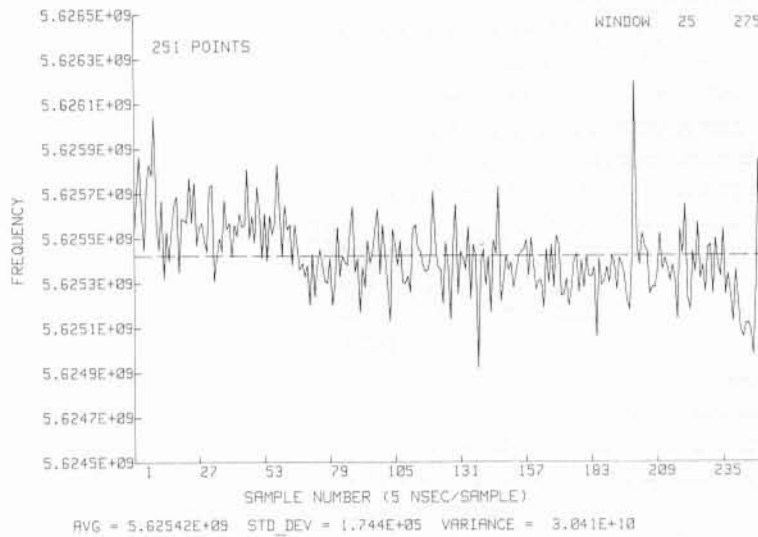

Figure 31. SPS-10 Radar Frequency Profile (Long Pulse)

The radar frequency profile pdf histograms for short pulse and long pulse operation of the SPS-10E radar are shown in Figures 32, 33, respectively. Sample windows used for the radar average frequency profile histogram plots are the same as those used for the radar average frequency profile point plot.

The pdf histogram for short pulse operation is a narrow distribution with multiple outlying data points. The average frequency is 5.62585 GHz and within the specified transmitter values indicated in Table 3.

The pdf histogram for long pulse operation is distinctly Gaussian, and indicative of the random nature of the samples depicted in the radar frequency profile point plot (Figure 31). The average frequency in this case is 5.62542 GHz.

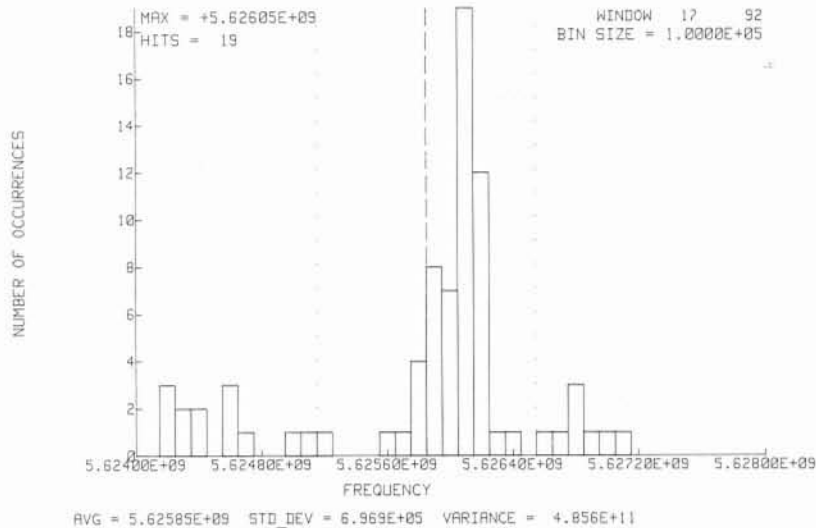

Figure 32. SPS-10 Radar Frequency Profile Histogram (Short Pulse)

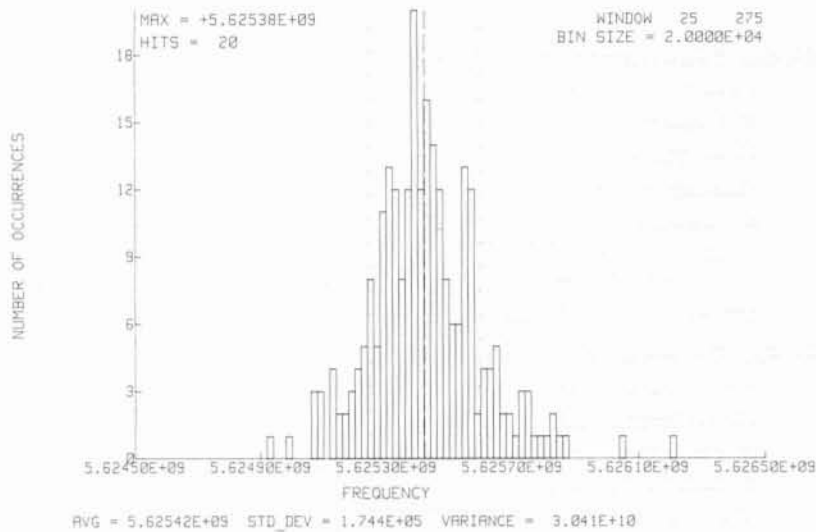

Figure 33. SPS-10 Radar Frequency Profile Histogram (Long Pulse)

C. AN/SPS-40A RADAR SYSTEM

1. Radar Technical Characteristics

The AN/SPS-40A is a UHF-band Naval search and surveillance radar for the detection of air targets at long and medium distances. It was introduced into the U.S. Navy in the early 1960's and is currently utilized on numerous ship classes. Also, this radar has been fitted on ships of many foreign Navies.

The SPS-40A is a coherent linear FM pulse compression (Chirp) radar with an analog MTI in the IF section. Two stages of high-level power amplification produce the 200 kW (peak power) RF pulse for radiation at approximately 425 MHz. The radar operates with a single pulsewidth of 60 usec and a PRF of 300 Hz. The Compression ratio is 60:1 and the MTI improvement factor is 33dB. The radar is equipped with a horizontally polarized feedhorn and parabolic type reflector whose gain is approximately 21 dB. The linear video signal from the radar receiver system and the MTI video from the MTI system are processed by the radar indicating system.

A SPS-40A radar system block diagram is presented in Appendix A, Figure 68. Reference 7 contains a detailed technical description for this radar. SPS-40A radar technical specifications are summarized in Table 5. The HP 8569B Spectrum Analyzer is used to generate the power spectra of the transmitter signal presented in Figure 34. As expected, this radar waveform results in a flat power spectrum signature over the effective bandwidth.

Table 5. SPS-40A Radar — Summary of Technical Specifications

Radar Transmitter Characteristics

| | |
|----------------------------|---------------|
| Peak Power (kW) | 200 - 255 |
| Pulsewidth (μ sec) | 60 |
| Pulse Repetitive Frequency | 300 |
| Average Power (W) | 3600 - 4400 |
| Emission Bandwidth (kHz) | 50 |
| Transmitter Type | Tetrode |
| Frequency Range (MHz) | 402.5 - 447.5 |
| Operating BW (MHz) | 50 |

Radar Receiver Characteristics

| | |
|----------------------------------|-------------|
| Minimum Discernible Signal (dBm) | -110 |
| Noise Figure (dB) | 7 |
| IF Frequency (MHz) | 15 |
| IF Bandwidth (kHz) | 70 and 1700 |
| MTI Improvement Factor (dB) | 33 |
| Pulse Compression Ratio | 60:1 |

Radar Antenna Characteristics

| | |
|--------------------------------|---------------------------------|
| Antenna Type | Parabolic Reflector |
| Antenna Gain (dB) | 21 |
| Polarization | Horizontal |
| Beamwidth (Degrees) | Horizontal: 11 Vertical: 19 |
| Horizontal Sidelobe Level (dB) | -27 |
| Scan Coverage (Degrees) | Horizontal: 360 Vertical: 19 |
| Horizontal Scan Rate (Rev/Min) | 6 |

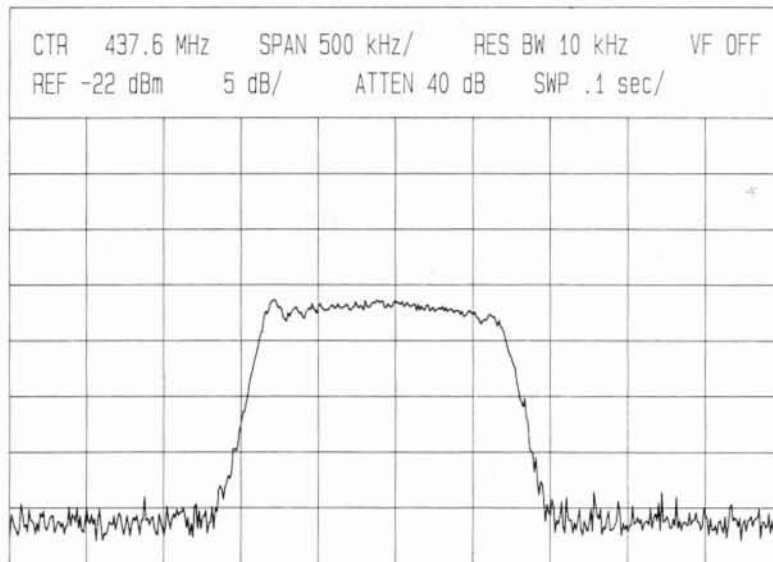

Figure 34. SPS-40A Transmitter Pulse Power Spectrum

2. Transmitter Subsystem Test Measurement Configurations

Test configurations are similar to those used for parameter data collection on the SPS-10E radar (see *Figures 13 and 14*). This test setup does not include the HP 5356A frequency converter head and the HP 5355A automatic frequency converter. Also, the RF processor is configured to the SPS-40A radar.

a. Radar Waveform Parameter Measurements

Three radar parameter measurements are made on the AN/SPS-40A radar using the test measurement setup of *Figure 13*: frequency, pulsewidth and pulse repetition frequency.

HP 5345 electronic counter settings are given in *Table 4*. The average RF frequency is measured by applying an appropriately attenuated signal to the HP 5345A electronic counter. PW, and PRF parameters are measured using the output of the RF detector. A photograph of the detected pulse presented in *Figure 35* is obtained by using the HP 1725A oscilloscope.

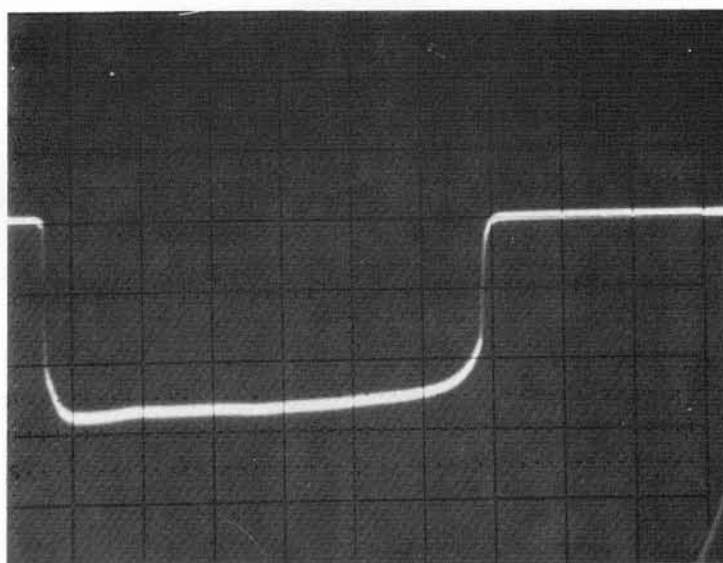

Figure 35. SPS-40A Detected RF Pulse

b. Radar Waveform Average Frequency Profile

Radar average frequency profile signature measurements are made using the average frequency profile test setup shown in *Figure 14*. A description of this test measurement is found in Section V. Radar Test Results, item B.2.b. page 24.

3. Test Results

The SPS-40A radar transmitter test results are presented in this section.

a. Frequency/Time Interval Measurements

(1) AVERAGE RADAR FREQUENCY

The attenuated radar transmitter signal is applied directly to the HP 5345A Electronic Counter (see Figure 13). The HP 5345A FUNCTION SWITCH is set to **FREQ A** and GATE TIME is 1 ms for this measurement. One thousand frequency data samples are measured and stored.

The SPS-40A radar frequency point plot is presented in Figure 36. Radar frequency (MHz) and sample number are plotted on the Y and X axes respectively. Average frequency (horizontal dashed line), standard deviation and variance are automatically calculated using the statistical analysis program in the HP 9000/217 computer and results are presented.

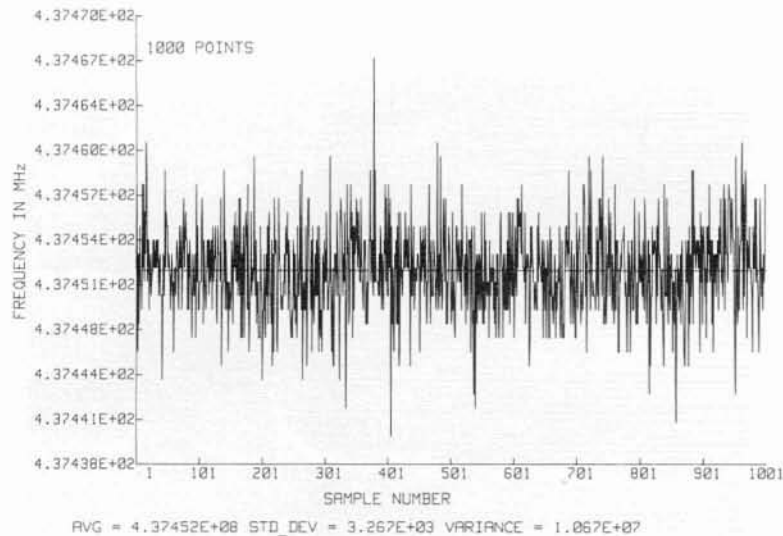

Figure 36. SPS-40A Radar Frequency Point Plot

The pdf histogram of the SPS-40A radar's average frequency parameter (Figure 37) is automatically computed and plotted using the HP 7475A plotter.

The approximate Gaussian distribution confirms the random distribution visually observed in the frequency point plot (see Figure 36). The selected bin size is 1.3 KHz. The standard deviation is 3.267 KHz and the average frequency is 437.452 MHz.

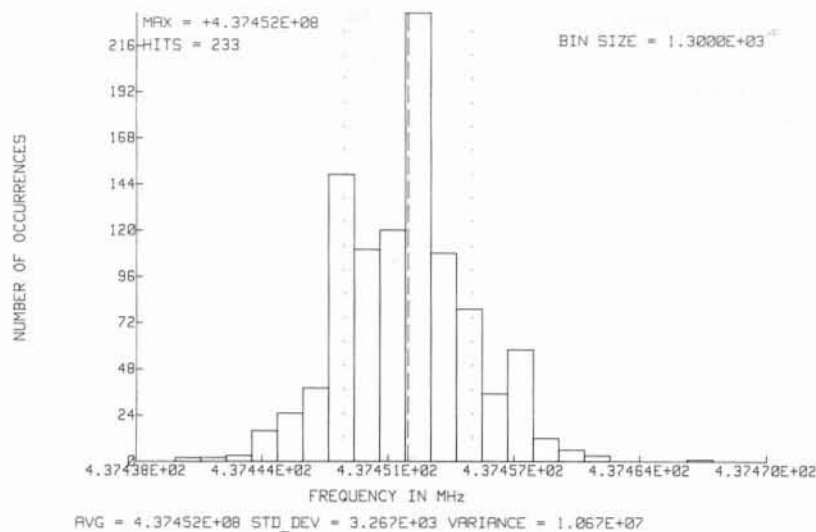

Figure 37. SPS-40A Radar Frequency Histogram

(2). RADAR PULSEWIDTH

Radar pulsewidth data collection is made on the SPS-40A radar using the test measurement setup illustrated in Figure 13. The HP 5345A control settings are: FUNCTION SELECTOR — TIME INTERVAL; TRIGGER LEVEL CONTROL — -125 mv; SLOPE SWITCH +/-; GATE TIME 1 ms.

The radar pulsewidth point plot is illustrated in Figure 38. The unusual “dip” detected in the point plot between sample 600 and 900 may warrant further investigation depending on the radar’s design criteria. The expanded pulsewidth point plot (window 301 — 400) shown in Figure 39, appears nearly sinusoidal.

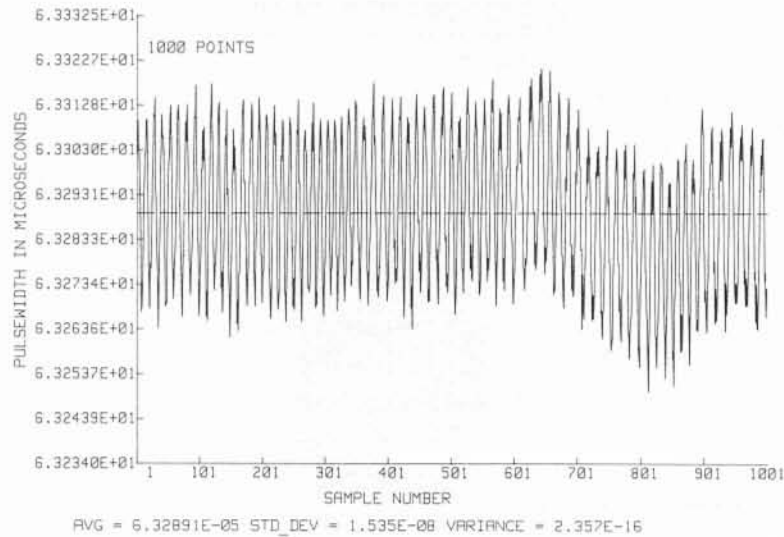

Figure 38. SPS-40A Radar Pulsewidth Point Plot (1000 Points)

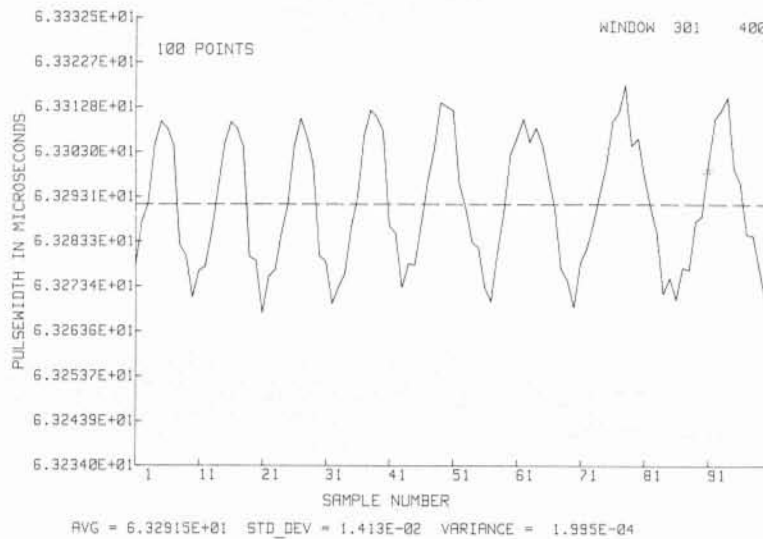

Figure 39. SPS-40A Radar Pulsewidth Point Plot (100 Points)

The pdf histogram (Figure 40) of the radar pulsewidth is approximately constant. The average 63.2891 us pulsewidth compares favorably with the specified value of 60 μ s (Table 5). The pulsewidth's standard deviation is 15.35 ns. This compressed PW (in the receiver) will effectively determine the range resolution capability for the chirped radar waveform.

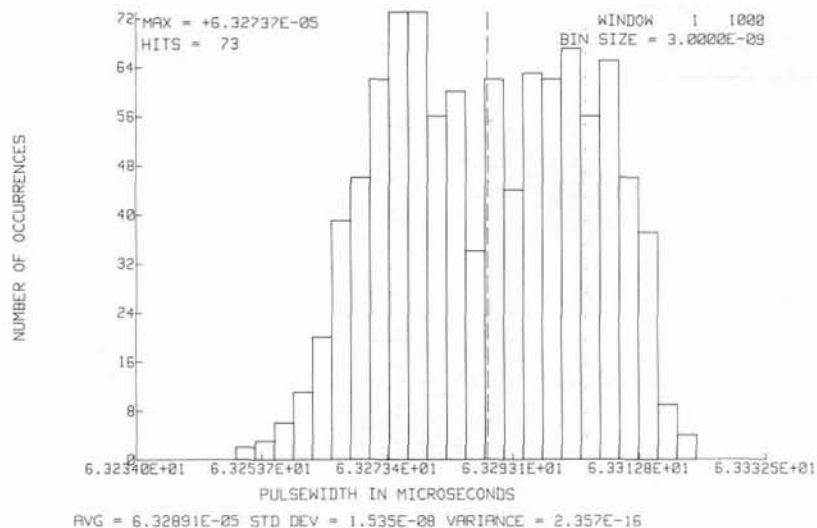

Figure 40. SPS-40A Radar Pulsewidth Histogram

(3). PULSE REPETITION FREQUENCY

The HP 5345A control settings for PRF parameter measurements are: FUNCTION SELECTOR — FREQ A; TRIGGER LEVEL CONTROL — -125 mv; SLOPE SWITCH -/-; GATE TIME — MIN.

The radar PRF point plot is shown in Figure 41. PRF is measured in Hz (y axis) and sample number is indicated on the x axis. The PRF point plot reveals the random variable nature associated with the PRF parameter. The HP Electronic Counter and computer provide the fundamental capability to quantify and statistically describe these elemental radar waveform parameters.

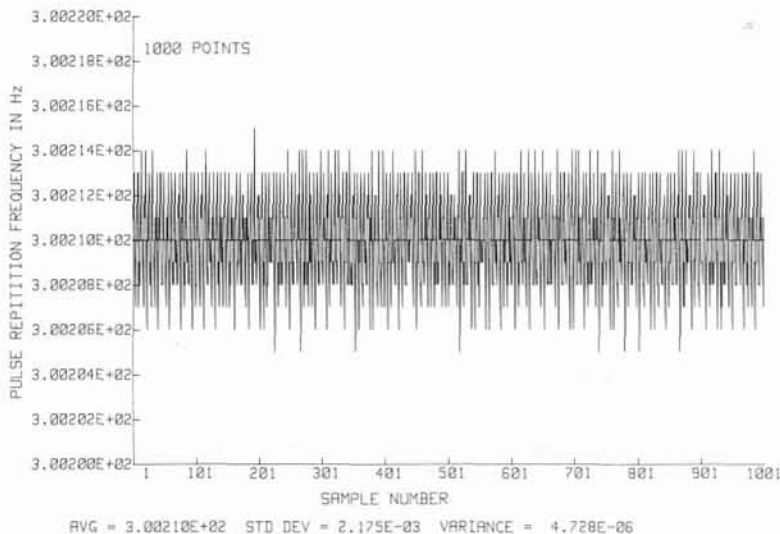

Figure 41. SPS-40A Pulse Repetition Frequency Point Plot

The pdf histogram of radar PRF is shown in *Figure 42*. The average measured PRF is 300.210 Hz which compares favorably with the specified value of 300 Hz (*Table 5*). Standard deviation of the PRF is .002175 Hz. The coherent capability of the SPS-40A radar is, in part, defined by the closely controlled PRF characteristics.

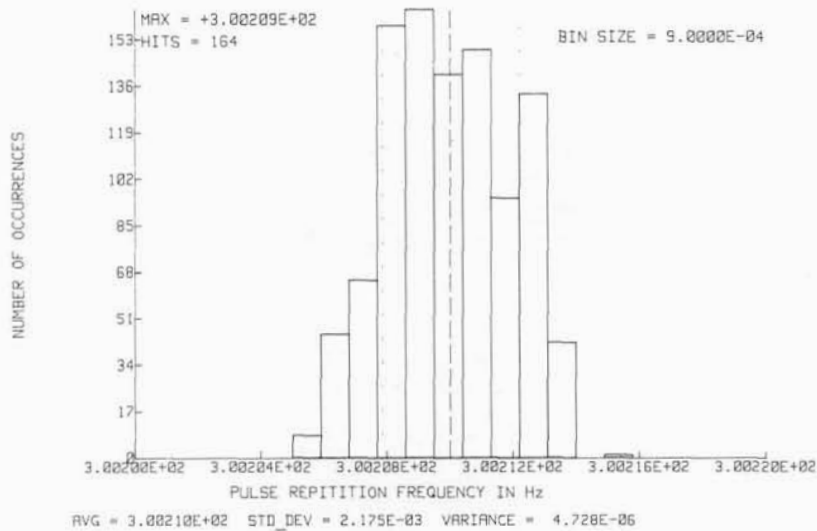

Figure 42. SPS-40A Radar Pulse Repetition Frequency Histogram

b. Average Frequency Profile

The SPS-40A radar average frequency profile signature measurement data collection is accomplished with the test measurement setup illustrated in *Figure 14*. An appropriately attenuated signal is applied to the HP 5345A Electronic Counter. Start delay/stop delay/step size are .5 μ s/65 μ s/.1 μ s respectively. A radar trigger pulse is used to externally trigger the measurement equipment.

The average frequency profile point plot for the SPS-40A is shown in *Figure 43*. This average frequency profile signature illustrates the linear frequency (Chirp) characteristic of the SPS-40A radar. This linear frequency profile characteristic contains important radar waveform information, which can be used to derive range resolution and bandwidth.

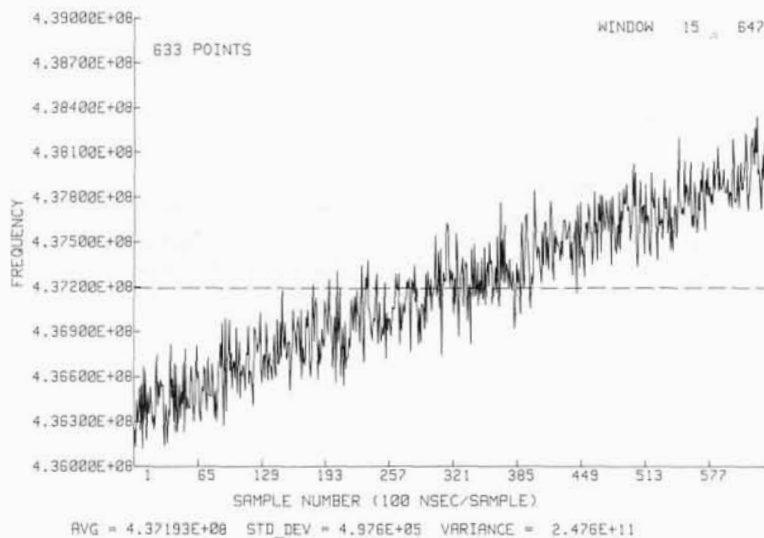

Figure 43. SPS-40A Radar Frequency Profile Point Plot

A pdf histogram of the radar average frequency profile signature is presented in *Figure 44*. The constant pdf characteristic is as expected for a linear or chirped frequency characteristic. The histogram bin size is .1 MHz. The standard deviation is .4979 MHz.

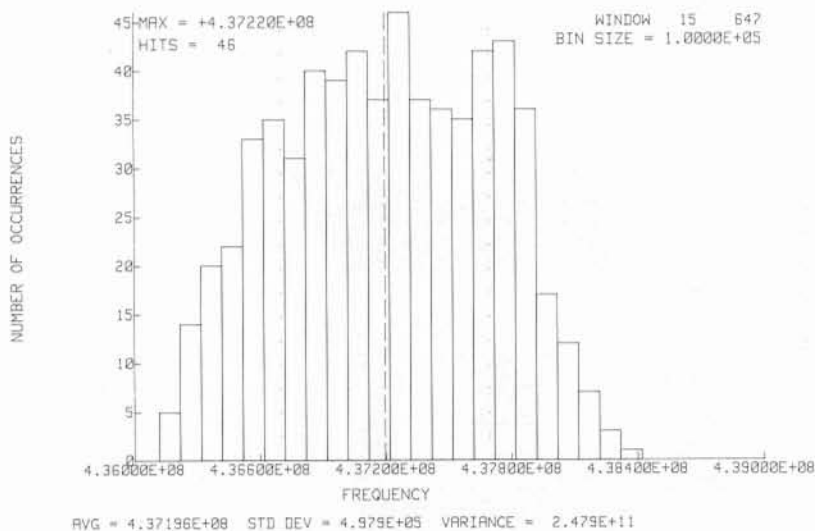

Figure 44. SPS-40A Radar Frequency Profile Histogram

D. AN/SPS-65(V)1 RADAR SYSTEM

1. Radar Technical Characteristics

The AN/SPS-65(V)1 is the latest U.S. Navy version of the basic AN/SPS-58 radar. The SPS-65(V)1 is a L-band, pulse doppler, air search and acquisition radar. This radar was designed to operate with the U.S. Navy point defense surface missile system.

The AN/SPS-65(V)1 radar features digital design for improved performance in heavy clutter from high sea states and land masses. Its gated digital doppler processing and digital clutter cancelling enable the radar to discriminate low-flying targets from ocean clutter. Moving targets appear in the radar set's MTI output, which displays all detected targets having radial velocities between 100 and 1800 knots. Surface and airborne targets both appear in the radar set's normal output, which also displays landmass contours.

The radar transmitter's klystron generates a peak power of 12 kilowatts at an RF frequency of approximately 1.3 GHz. The radar operates with a 7 μ s. pulsewidth and a PRF of 2315 to 3064 pulses per second. The radar is equipped with a vertically polarized parabolic type reflector whose gain is 23 dB.

A block diagram of the AN-SPS-65(V)1 radar is presented in Appendix A, *Figure 69*. Reference 8 contains a detailed technical description for this radar. SPS-65(V)1 radar technical specifications are summarized in *Table 6* (Reference 6). The HP 8569B Spectrum Analyzer is used to generate the power spectra of the transmitter signal presented in *Figure 45*.

Table 6. AN/SPS-65(V)1 Radar — Summary of Technical Specifications

Radar Transmitter Characteristics

| | |
|----------------------------|-------------|
| Peak Power (kW) | 12 |
| Pulsewidth (μ sec) | 7 |
| Pulse Repetitive Frequency | 2315/3064 |
| Average Power (W) | 250 |
| Emission Bandwidth (kHz) | 30,000 |
| Transmitter Type | Klystron |
| Frequency Range (MHz) | 1215 - 1365 |
| Operating BW (MHz) | 150 |

Radar Receiver Characteristics

| | |
|----------------------------------|--------|
| Minimum Discernible Signal (dBm) | -112 |
| Noise Figure (dB) | 4 |
| IF Frequency (MHz) | 30 |
| IF Bandwidth (kHz) | 10,000 |
| MTI Improvement Factor (dB) | 60 |

Radar Antenna Characteristics

| | |
|--------------------------------|---------------------------------|
| Antenna Type | Parabolic Reflector |
| Antenna Gain (dB) | 23 |
| Polarization | Vertical |
| Horizontal Sidelobe Level (dB) | -23 |
| Scan Coverage (Degrees) | Horizontal: 360 Vertical: 16 |
| Horizontal Scan Rate (Rev/Min) | 15 |

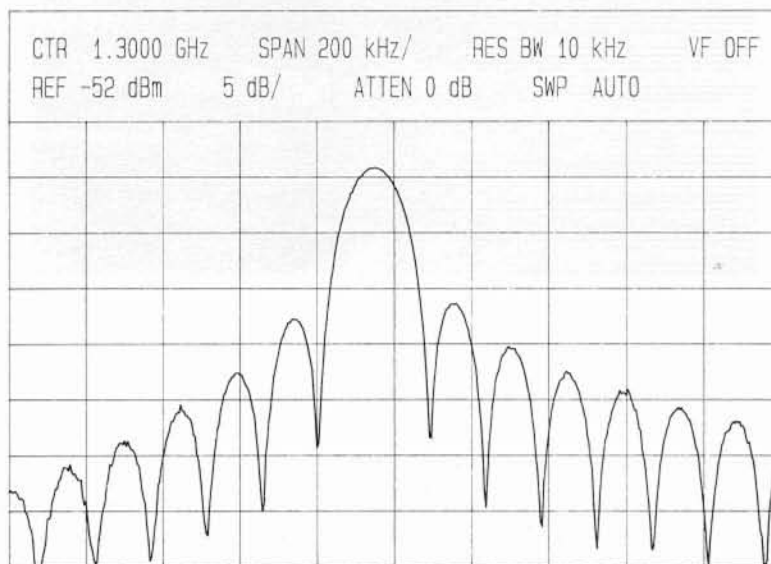

Figure 45. SPS-65(V)1 Transmitter Pulse Power Spectrum

2. Transmitter Subsystem Test Measurement Configurations

Test configurations are similar to those used for parameter data collection on the SPS-10E radar (see *Figures 13 and 14*). An additional piece of test equipment, the HP 5363B Time Interval Probes, is added to facilitate pulse risetime/falltime measurements.

a. Radar Waveform Parameter Measurements

Four parameter measurements are made on the AN/SPS-65(V)1 radar utilizing the test measurement setup of *Figure 13*: frequency, pulsewidth, pulse risetime and pulse falltime.

RF frequency is measured by applying an appropriately attenuated signal to the HP 5345A/HP 5355A system. Pulsewidth measurements are made by applying the RF detector output directly to the HP 5345A Electronic Counter.

Pulse risetime/falltime measurements are made by applying the RF detector output to the HP 5363B Time Interval Probes, whose output is supplied the HP 5345A Electronic Counter.

The HP 5363B Time Interval probes are designed to overcome special problems encountered in pulse risetime/falltime measurements; i.e. — Trigger point determination, circuit loading errors and system propagation delay errors. A discussion of this topic may be found in Reference 2.

Standard HP 5345A control settings for the SPS-65(V)1 parameter measurements are contained in *Table 2 (p. 15)*. A photograph of the detected transmitter pulse presented in *Figure 46* is obtained using the HP 1725A oscilloscope.

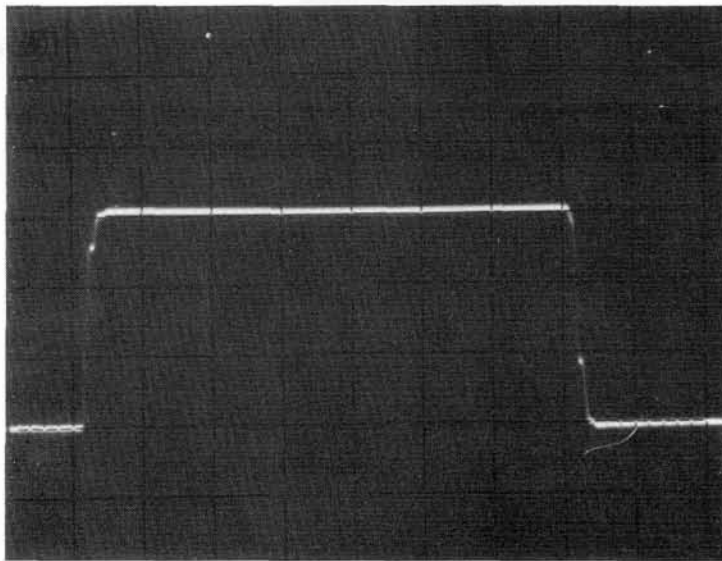

Figure 46. SPS-65(V)1 Detected RF Pulse

b. Radar Waveform Average Frequency Profile

Radar average frequency profile measurements on the SPS-65(V)1 radar are made utilizing the radar waveform average frequency profile test measurement setup shown in *Figure 14*.

3. Test Results

SPS-65(V)1 radar transmitter test results are presented in this section.

a. Frequency/Time Interval Measurements

(1). RADAR FREQUENCY

The attenuated transmitter signal is applied directly to the PRE-SCALAR input of the HP 5355A Automatic Frequency Downconversion Plug-in unit. The HP 5345A Electronic counter FUNCTION SELECTOR is set to PLUG-IN. The HP 5345A GATE TIME is set to 100 μ s.

The frequency parameter point plot for the SPS-65(V)1 radar is presented in Figure 47. Frequency is presented in GHz on the Y axis with sample number on the X axis. The horizontal dashed line represents the average RF frequency, in this case 1.29898 GHz.

The pdf histogram of the radar's frequency parameter is presented in Figure 48. Standard deviation, variance and average frequency value are automatically calculated and presented.

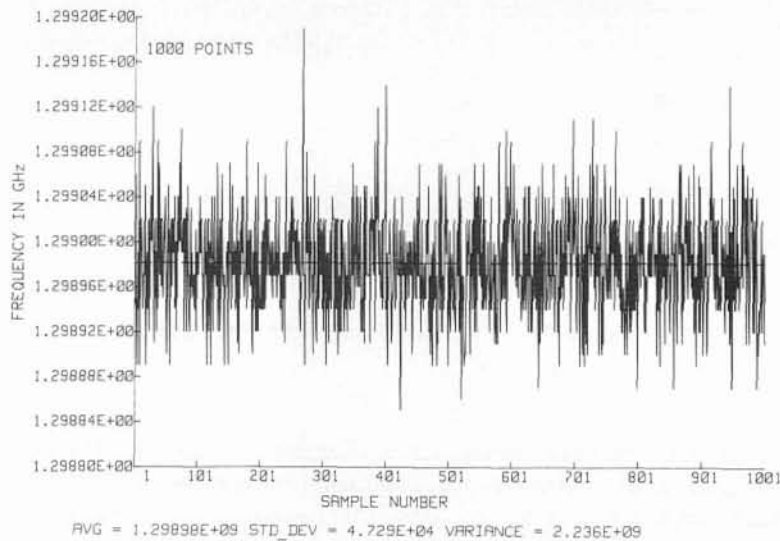

Figure 47. SPS-65(V)1 Radar Frequency Point Plot

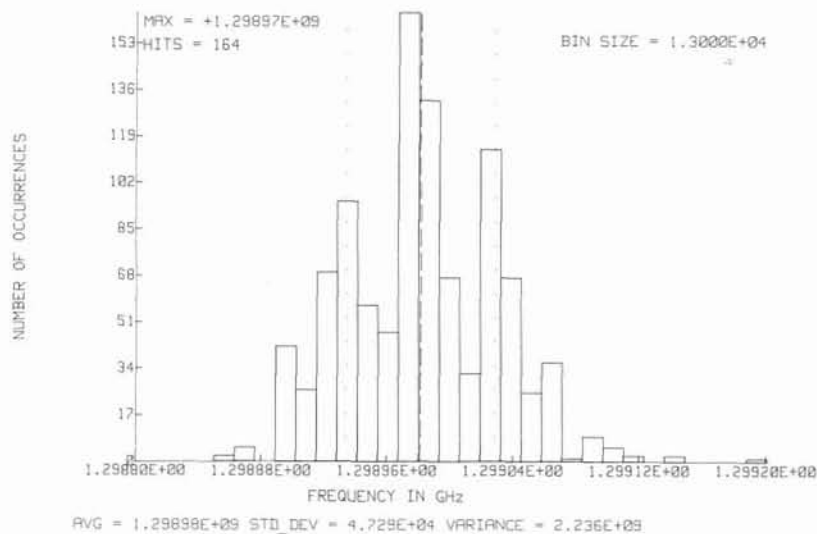

Figure 48. SPS-65(V)1 Radar Frequency Histogram

(2). RADAR PULSEWIDTH

Radar pulsewidth data collection is performed on the SPS-65(V)1 radar and shown in Figure 49. The HP 5345A control settings are : FUNCTION SELECTOR — TIME INTERVAL; TRIGGER LEVEL CONTROL +1.5v; SLOPE SWITCH +/-; GATE TIME -100 μ s.

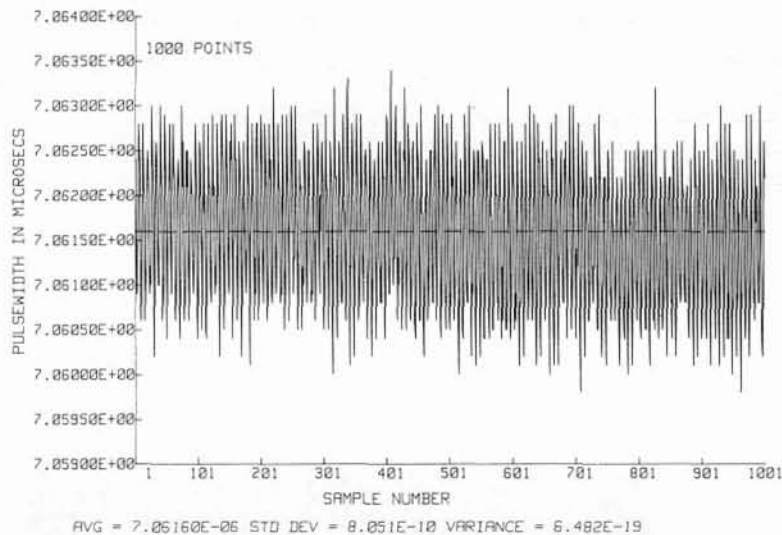

Figure 49. SPS-65(V)1 Pulsewidth Point Plot

The pdf histogram of the radar pulsewidth is revealed in Figure 50. The average pulsewidth parameter is 7.0616 μ s. which compares favorably with the specified value of 7 μ s. (Table 6). The pulsewidth standard deviation is .8051 ns. These PW variations will cause only minor degradation in radar range resolution performance.

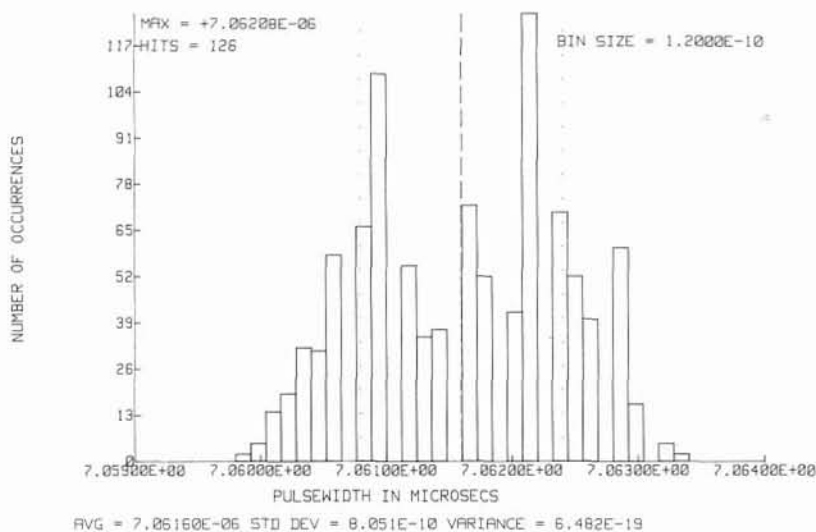

Figure 50. SPS-65(V)1 Radar Pulsewidth Histogram

(3). PULSE RISETIME/FALLTIME

Radar risetime/falltime data collections are made on the SPS-65(V)1 radar utilizing the test measurement setup shown in *Figure 13*. The HP 5345A control settings are: FUNCTION SELECTOR — TIME INT A TO B; TRIGGER LEVEL CONTROL — CHAN. A +0.3 Volts, CHAN. B +2.7 Volts; SLOPE SWITCH +/+ or -/-. The HP Electronic Counter and associated computer provide a dramatic savings of time for these radar parameter measurements and storage.

Radar pulse risetime and falltime point plots are presented in *Figures 51* and *52*, respectively. In each case, the radar parameter is indicated on the vertical axis in ns and the sample number is plotted on the horizontal axis. The radar RF pulse risetime point plot reveals a small distinctly sinusoidal component. Radar RF pulse falltime point plot exhibits the unique characteristic shown in *Figure 52*.

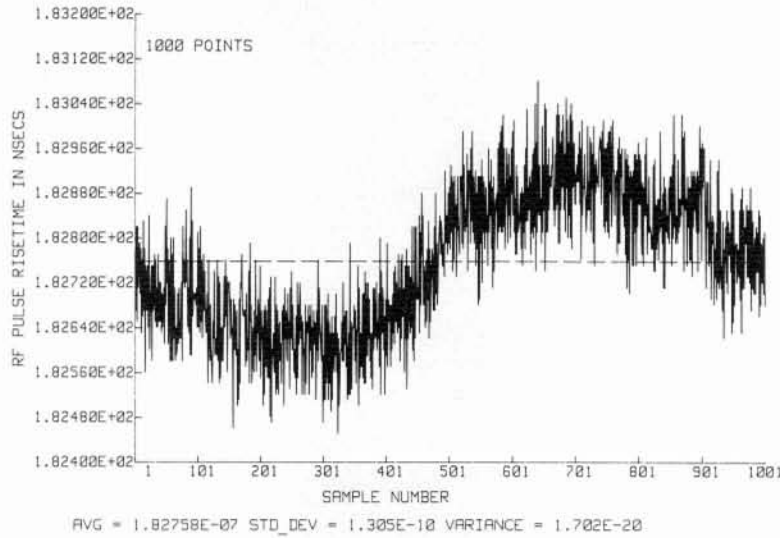

Figure 51. SPS-65(V)1 Radar RF Pulse Risetime

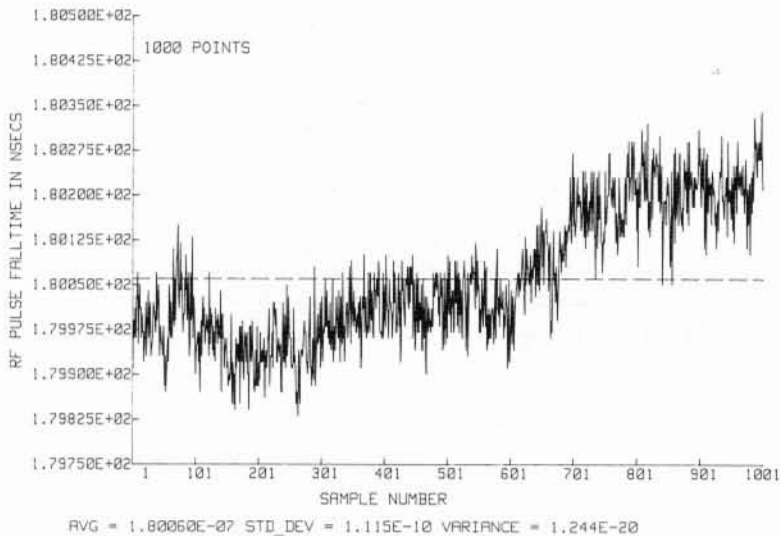

Figure 52. SPS-65(V)1 Radar RF Pulse Falltime

The pdf histograms for the radar RF pulse risetime and falltime are shown in Figures 53 and 54, respectively. The average risetime is 182.758 ns. The average falltime is 180.060 ns. Pulse risetime is directly related to the accuracy of the target range measurement, hence pdf (risetime) is very important for determining the range accuracy characteristic.

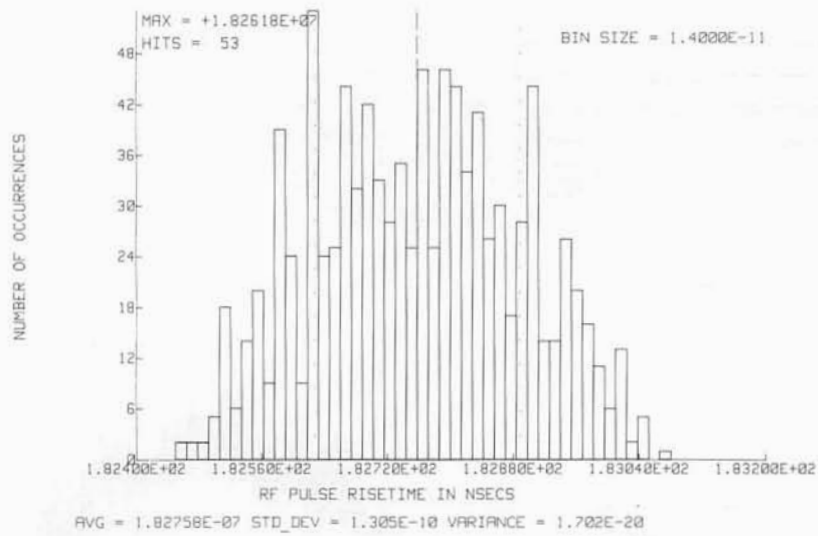

Figure 53. SPS-65(V)1 Radar RF Pulse Risetime Histogram

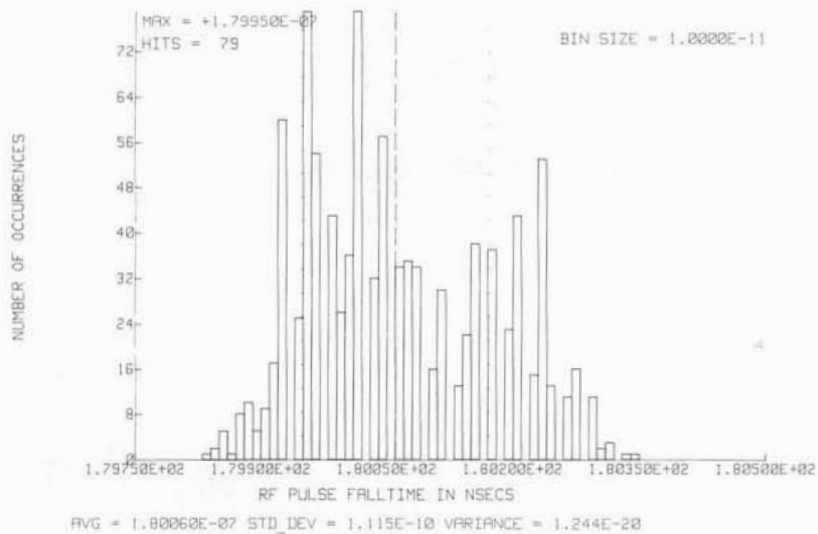

Figure 54. SPS-65(V)1 Radar RF Pulse Falltime Histogram

b. Average Frequency Profile Signature Measurements

An appropriately attenuated signal is applied to the PRESCALAR INPUT of the HP 5345A/5355A system.

The radar frequency profile point plot for the SPS-65(V) 1 is shown in Figure 55. The pdf histogram (Figure 56) of the average frequency profile is a distinct Gaussian distribution.

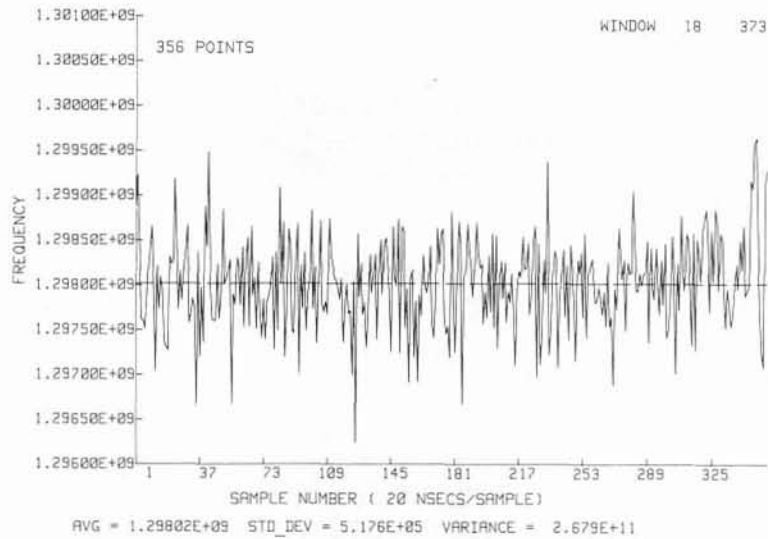

Figure 55. SPS-65(V)1 Radar Frequency Profile

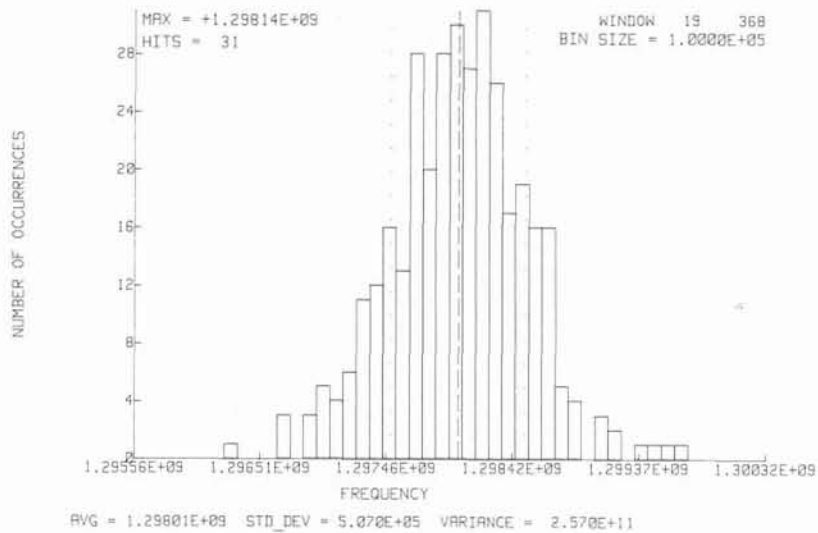

Figure 56. SPS-65(V)1 Radar Frequency Profile Histogram

VI. PHASE CODED RADAR PULSE PARAMETER MEASUREMENTS

A. INTRODUCTION

Modern radar systems use a variety of modulation or coding methods to enhance performance. Phase coding accomplishes two significant radar benefits, improved sensitivity and resolution. Thirteen bit barker codes have been used in this application to provide pulse compression.

In this section a simulated, phase coded, coherent radar pulse waveform is generated with commercial test equipment and several parameter measurements are performed using the HP 5345A Frequency Counter. Average frequency within a phase stable bit of the RF pulse is measured using external gating control. Intrapulse phase shift characteristics of a barker coded radar signal is measured. The reference clock to leading edge jitter is also measured yielding an effective interpulse jitter characterization.

These signal measurements are described with supporting figures. Data is presented in the form of descriptions, point plots or histograms. No attempt is made to analyze the results in terms of expected improvement to an actual radar system.

B. MEASUREMENT SET UP

Figure 57 illustrates the commercial test equipment set up for generating a 1111100110101 (13 bit) barker coded pulse at 2.940 GHz. The pulse width is set by the HP 5359A Time Synthesizer at 130 microseconds long. The PRF is 3.125 kHz. Phase shifts of 180 degrees occur at RF frequency according to the bit code throughout the pulse. The phase modulation is generated by a bipolar signal from the HP 8175A Digital Signal Generator driving the diodes in a double balance mixer. The RF signal is generated with HP 8340A Synthesized Sweeper. A HP 8672A Synthesized Sweep Generator and mixer are used as a coherent down converter to provide the 60 Mhz IF frequency. All test instruments are phase locked together to ensure coherency between pulses from the barker code simulator generating system.

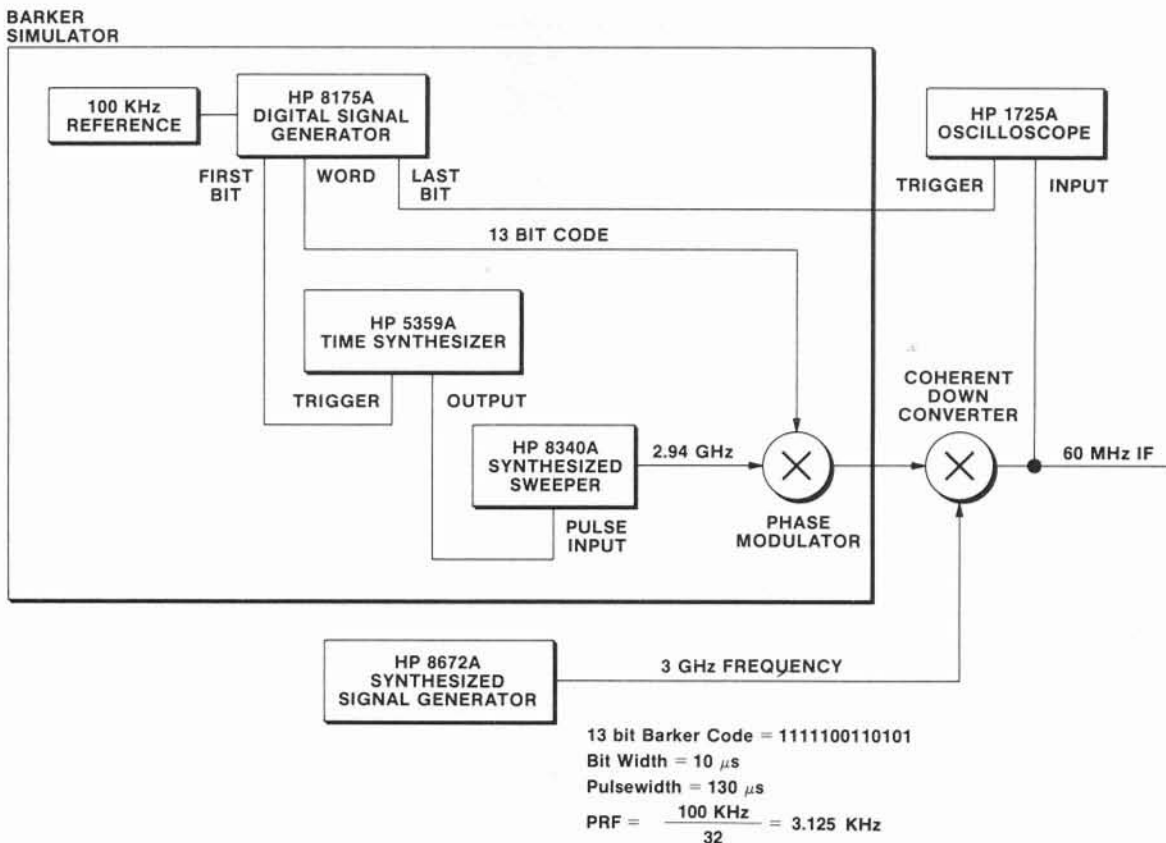

Figure 57. Barker Coded Simulator Generator and Down Converter Block Diagram

A photograph of the barker coded signal as displayed on an HP 1725A Oscilloscope is shown in *Figure 58*.

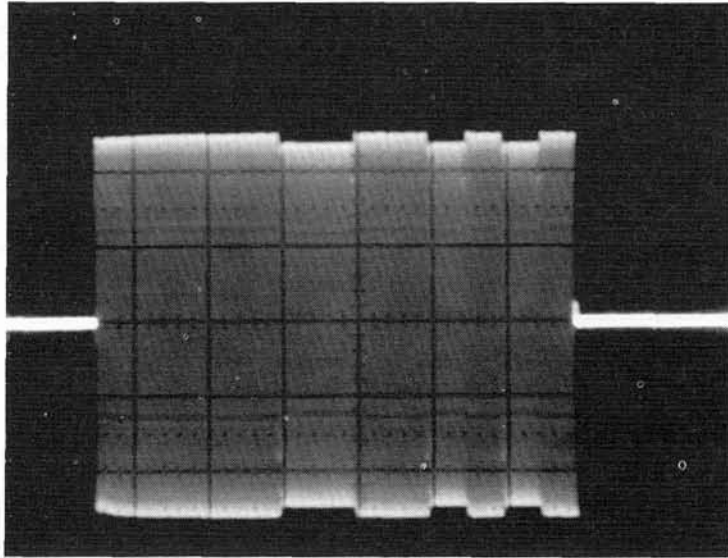

Figure 58. Barker Coded IF Signal

C. BARKER CODED PULSE AVERAGE FREQUENCY PROFILE

The HP 5345A/55A RF down converter head is connected to the pulse source derived by the barker coded simulation system as shown in Figure 59. An HP 5359A Time Synthesizer is used to generate a gate signal for the counter. The sync signal is derived from the HP 8175A Data Signal Generator and is synchronous with the bits of the barker code switching signal. The average frequency within the first five bits of the barker code is measured. The first five bits of the barker coded signal are 50 microseconds long. The 2.94 GHz signal is measured to 447 kHz resolution with a 100 ms gate. Higher resolution may be obtained through the selection of longer gate times. The frequency of the second stable bit of the barker sequence can be made by delaying the external gate. Continuing this process the frequency in each bit of the code is measured.

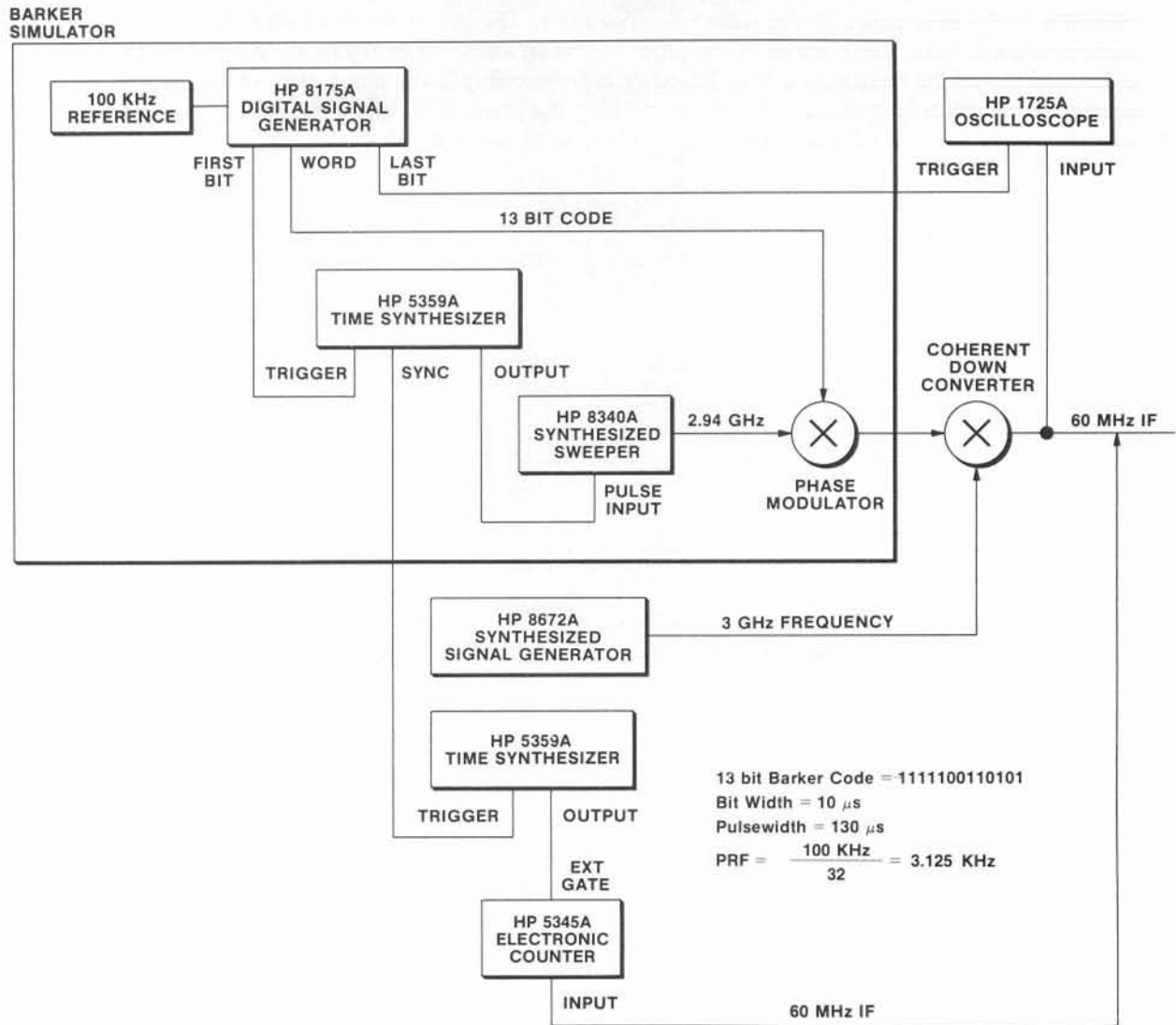

Figure 59. Barker Coded Pulse Average Frequency Profile Block Diagram

D. CHARACTERISTICS OF A BARKER CODED PHASE SHIFT

The HP 5345A Counter offers a unique capability. It will measure from one trigger point (the positive going zero crossing in this case) on the signal to another trigger point on a signal on a cycle by cycle basis. An external gate signal must be supplied to tell the counter where the measurement is to be made. Time interval can be measured over an interger number of cycles or trigger point occurrences.

The barker coded signal as it appears at the phase transition is shown in *Figure 60*. This point plot taken from an HP 54100A Digitizing Oscilloscope shows that the signal maintains coherency after the phase transition. The phase angle shift of the barker coded signal can be determined by measuring time from bit to bit. *Figure 61* shows the connections needed to make this measurement. The HP 5345A is used to measure the time interval over several cycles of the 60 MHz IF frequency. The HP 5359A is used to first position the gate of the counter in the single phase bit of the signal with reference to the sync output of the radar reference clock. The gate is then extended by integer periods of the IF such that it envelops the phase transition as shown in *Figure 62*. When the gate is positioned across the transition, a time difference corresponding to the phase shift will be present. A simple mathematical formula can be used to compute the phase shift. When measuring cycles of the single bit signal the time interval is equal to N times the period of the IF.

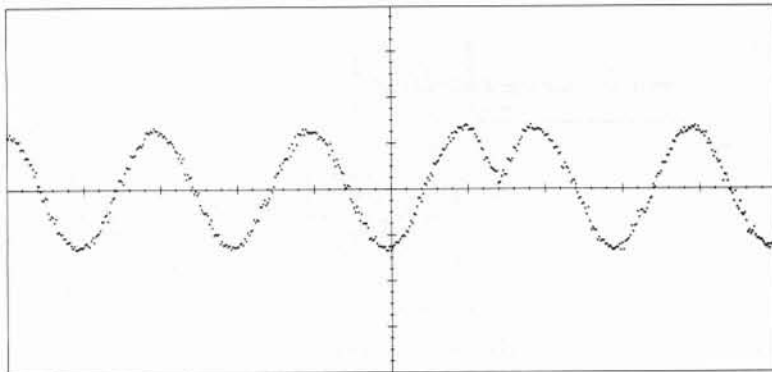

Figure 60. 180° Phase Shift in 60 MHz IF Signal

**BARKER
SIMULATOR**

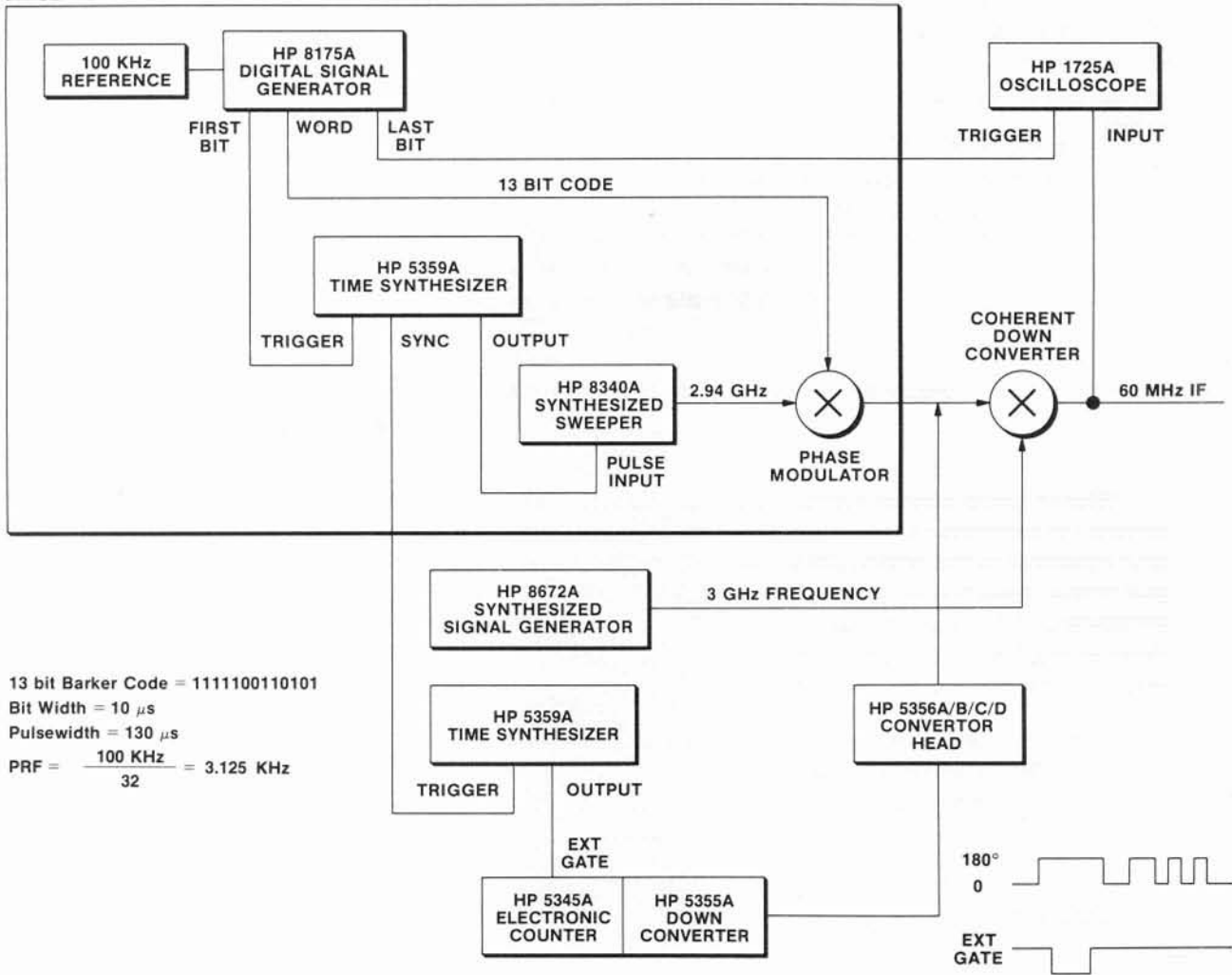

Figure 61. Barker Coded Phase Shift Block Diagram

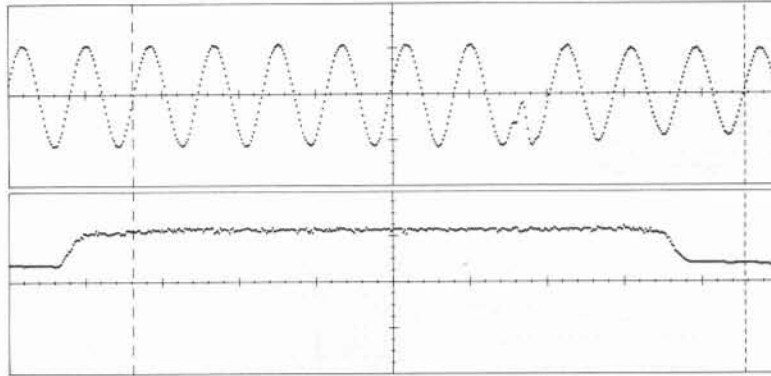

Figure 62. HP 5345A Gate Signal Relative to 180° Phase Shift

When a phase transition occurs, the angle shifts by $180^\circ \pm$ some difference. By measuring time across the transition the result will be equal to N times the period of the IF signal plus a fractional time equivalent to the desired phase shift and any transients. Figure 62 illustrates the position of the gate output signal relative to the phase shift. The counter measures from the zero crossing immediately after the positive gate signal opening until the zero crossing after the gate closes. By incrementing the external gate in approximate IF period steps, the cycle by cycle variation during the zero and one bits may be measured.

- If τ = period of the coherent IF frequency
- N = number of cycles
- τ_N = period of the N th cycle

$$\text{Delta Phi} = \frac{\tau_{N+1} - \tau_N}{\tau} \times 360$$

When the external gate is incremented across a phase shift and extra half period will be measured as shown in *Figure 63*. Phase modulation shift resolution may be improved through time interval averaging.

A phase modulation shift histogram is generated by taking a number of single shot time interval measurements and determining the mean, standard deviation and variance. This can be done using the software previously described and the HP 9000 series 200/300 computer.

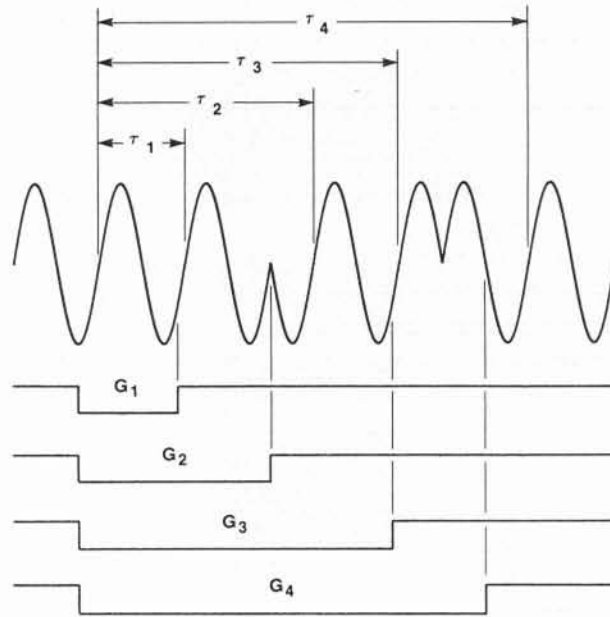

Figure 63. Barker Intrapulse Phase Measurements

E. REFERENCE CLOCK TO PULSE LEADING EDGE JITTER

Deviations in the phase angle at the beginning of a coded pulse may be caused by noise, or lack of coherence in the generating source. To ensure coherence, the source jitter must be minimized. The HP 5345A is connected as shown in Figure 64 where the sync output of the HP 5359A represents the radar reference clock. The HP 5345A is used to measure the time between the reference clock and the leading edge of the pulse. The variation in time may be due to noise, instability of the source or the modulator. Based on the stability of the reference clock, accurate interpulse jitter measurements can be calculated. The HP 5345A time interval capability is used to make this measurement. The reference clock of the radar is used to start the time interval measurement which is then terminated at the leading edge of the pulse. The time measured is the pulse leading edge variations which is representative of interpulse jitter. By making a number of these measurements, the mean, standard deviation and variance of the clock reference to pulse jitter can be computed and plotted. The leading edge of the the pulse is shown in Figure 65. The display as obtained from the HP 54100A Digitizing Oscilloscope. The noise on the pulse edge was averaged for 256 measurements before the plot was made.

Using the HP 5345A and an HP 9000 series 200/300 computer, 1000 10 ms average measurements were made on the 60 Mhz IF frequency. The plot in Figure 66 shows a mean of 30.0288 microseconds with a standard deviation of 2.843 nanoseconds. A bin size of 20 Picosecond, the resolution obtained through averaging, provides a gaussian distribution of the noise on the leading edge of the pulse.

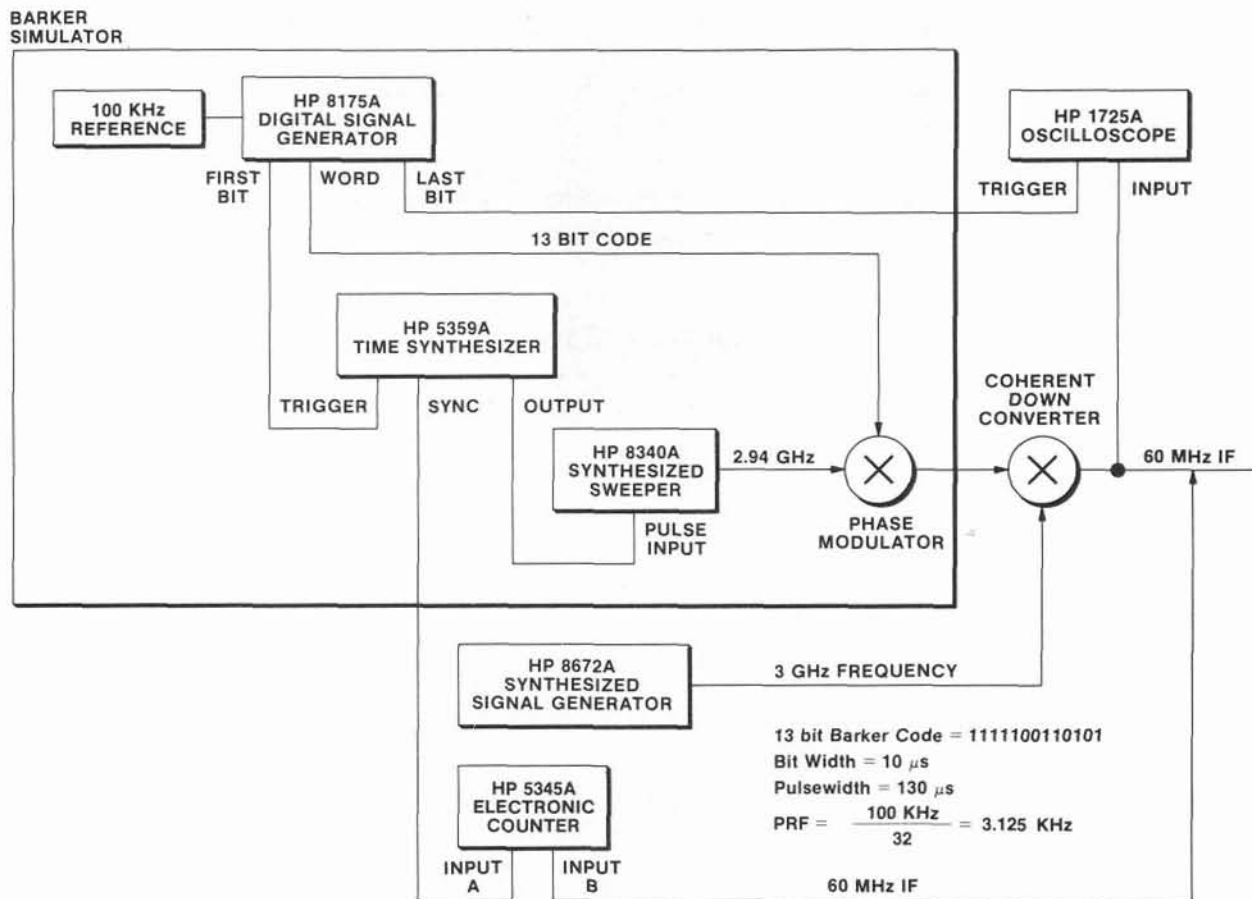

Figure 64. Reference Clock to Pulse Leading Edge Block Diagram

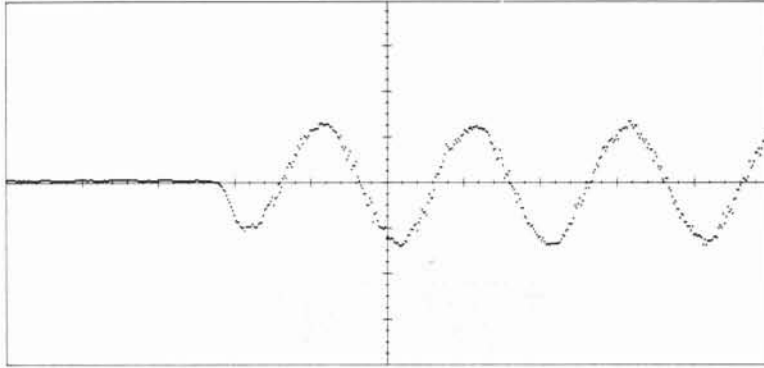

Figure 65. Radar Reference Clock to Leading Edge Delay

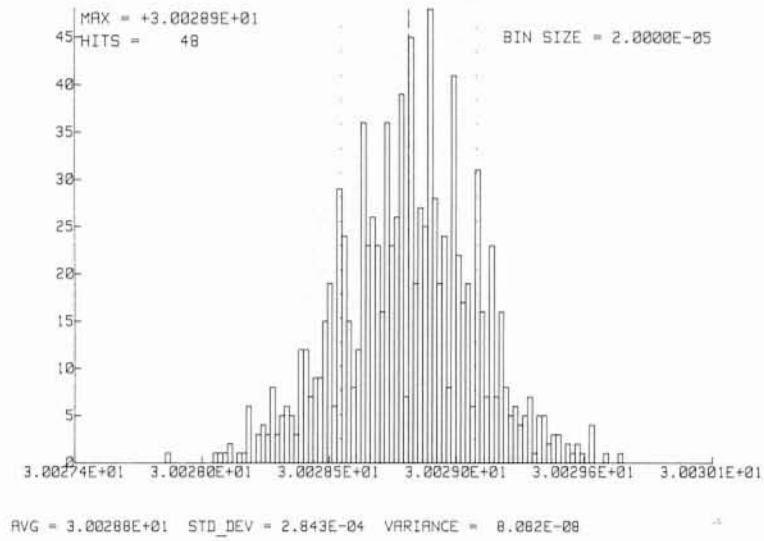

Figure 66. Interpulse Jitter Histogram

VII. CONCLUSIONS

The HP 5345A/5355A/5356A Electronic Counter/frequency downconverter combination provide a powerful test tool for precision time interval and frequency measurements of radar waveform parameters. The quantitative measurement performance capability is dramatically enhanced by interfacing (HP-IB bus) the HP 5345A Electronic Counter with a HP 9000 Series 200/300 Computer. The magnitude of collecting, storing, analyzing and preparing radar parameter test results presented in this application note using manual data collection methods is unthinkable.

The HP 5345A Electronic Counter/HP 9000 Series 200/300 Computer combination described in this application note, provide a highly sophisticated, time saving and precision method for radar transmitter subsystem testing and characterization.

Key radar waveform parameters are accurately and conveniently characterized for the SPS-10E, SPS-40A, and SPS-65(V)1 radar systems. Advanced radars with more complex waveforms can also be quantified and characterized using the HP 5345A Electronic Counter.

Section 7 of this application note presents a method of measuring phase coded radar signals using the HP 5345A/5355A/5356A electronic counter system. The signals are simulated using conventional test instruments and components and represent to the best of our knowledge a real world application in modern radar.

REFERENCES

1. Skolnik, Merrill I, "Introduction to Radar Systems," 2nd edition, McGraw-Hill Inc., USA, 1980.
2. "Fundamentals of the Electronic Counters", AN 200, Hewlett-Packard Co.
3. "Automatic Frequency Converter HP 5355A #18.6 GHz/26.5 GHz/40 GHz Frequency Converter Heads" Technical Data, Apr. 80, Hewlett-Packard Co.
4. "Application Guide to the HP 5355/56 Automatic Frequency Converter", AN 291-1, Hewlett-Packard Co.
5. "Technical Manual for Radar Sets AN/SPS-10 and AN/SPS-10C", NAVSEA 0967-LP-071-5010, Commander, Naval Sea Systems Command.
6. "Handbook for Shipboard Surveillance Radars", SE 200-AA-HBK-010, October 1982, Commander, Naval Sea Systems Command.
7. "Technical Manual for Radar Set AN/SPS-40A", NAVSHIPS 0967-255-1010, Dept. of the Navy - Naval Ships Systems Command.
8. "Technical Manual Volume 1, Radar Set AN/SPS-65(V)1 P/N 121B180G01", SE 212-10-MMO-010/C, Commander, Naval Sea Systems Command.

FURTHER READINGS ON ELECTRONIC COUNTERS

GENERAL INFORMATION:

1. "Electronic Measurements and Instrumentation", Barney Oliver and John Cage, McGraw-Hill, 1971, Chapter 6.
2. "Basic Electronic Instrument Handbook", Clyde Coombs, Editor, McGraw-Hill, 1972.
3. "Fundamentals of Quartz Oscillators", AN 200-2, Hewlett-Packard Co.
4. "AM, FM Measurements with the Transfer Oscillator", AN 141, Hewlett-Packard Co.
5. "Timekeeping and Frequency Calibration", AN 52-2, Hewlett-Packard Co.
6. For general information on Spectrum Analysis, see AN 150 Series, Hewlett-Packard Co.

RECIPROCAL COUNTERS:

1. Hewlett-Packard Journal, June 1974.
2. "Recent Advances in Pulsed RF and Microwave Frequency Measurements", AN 173, Hewlett-Packard Co.
3. "Measuring Linearity of VCO's from 10 Hz to 23 GHz", AN 181-1, Hewlett-Packard Co.
4. "Measuring the Tuning Step Response of VCO's to 18 GHz", AN 174-13, Hewlett-Packard Co.
5. "Dynamic Measurement of Microwave VCO's with HP 5345A Electronic Counter", AN 173-1, Hewlett-Packard Co.

TIME INTERVAL MEASUREMENTS:

1. "Precision Time Interval Measurements Using an Electronic Counter", AN 191, Hewlett-Packard Co.
2. "Time Interval Averaging", AN 162-1, Hewlett-Packard Co.
3. "Ovenless Oscillators will Resolve 20 Picosecond Pulses", Electronics, Nov. 10, 1977 Issue, pp. 89-95.
4. "Active Probes Improve Precision of Time Interval measurements", Hewlett-Packard Journal, Oct. 1975, pp. 11-16.
5. Hewlett-Packard Journal, April 1970.
6. "Precision T.I. Measurements in Radar Applications", AN 191-3, Hewlett-Packard Co.
7. "Measure Time Interval Precisely", Electronic Design, Nov. 22, 1974 Issue.

MICROWAVE COUNTERS:

1. "Fundamentals of Microwave Frequency Counters," AN 200-1, Hewlett-Packard Co.
2. "40 GHz Frequency Measurements with Standard HP Instruments", AN 190, Hewlett-Packard Co.
3. "Microprocessor-Controlled Harmonic Heterodyne Microwave Counter also Measures Amplitudes", May 1978, Hewlett-Packard Journal.

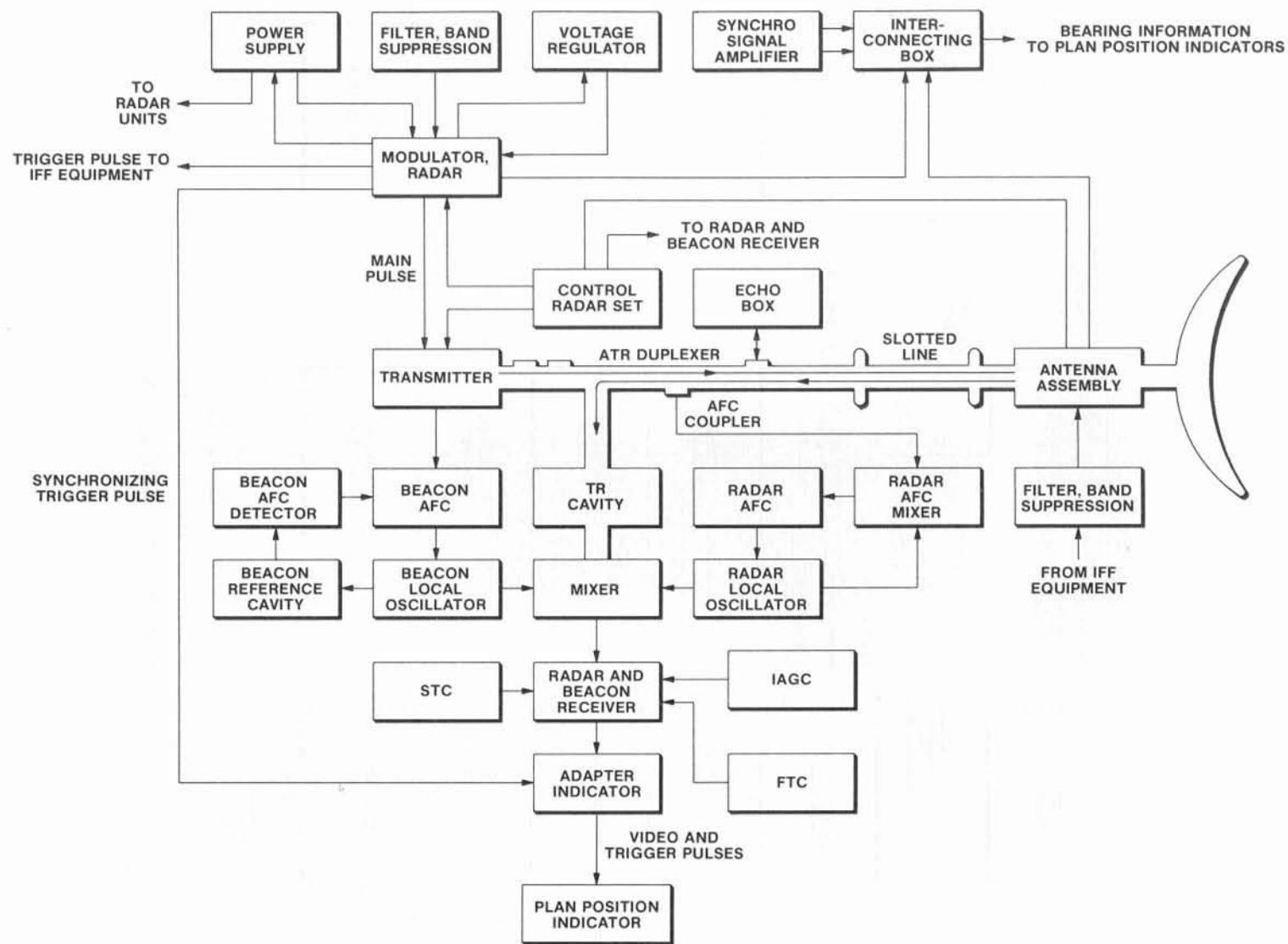

Figure 67. Radar Set SPS-10 Functional Block Diagram

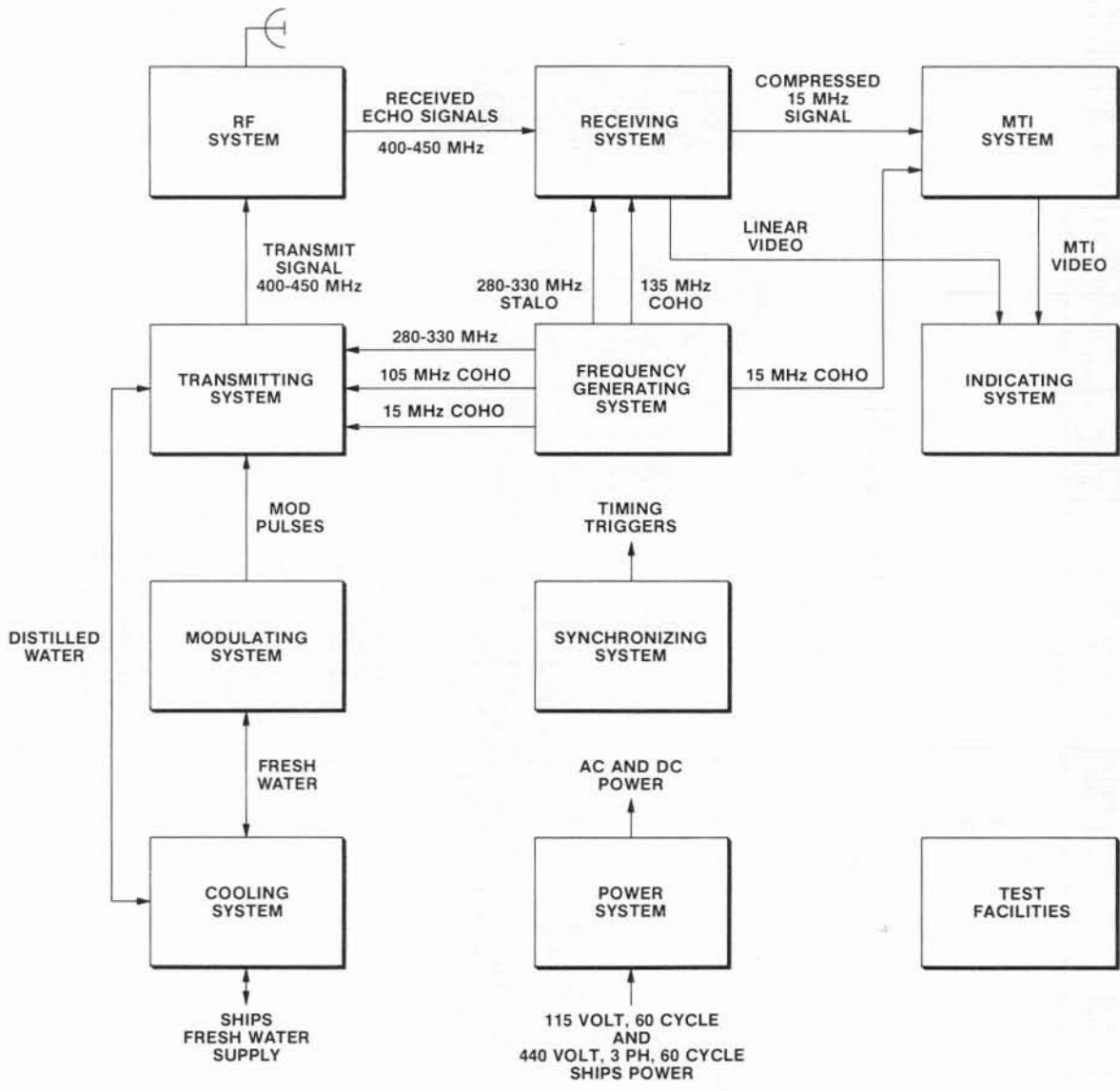

Figure 68. Radar Set SPS-40A System Block Diagram

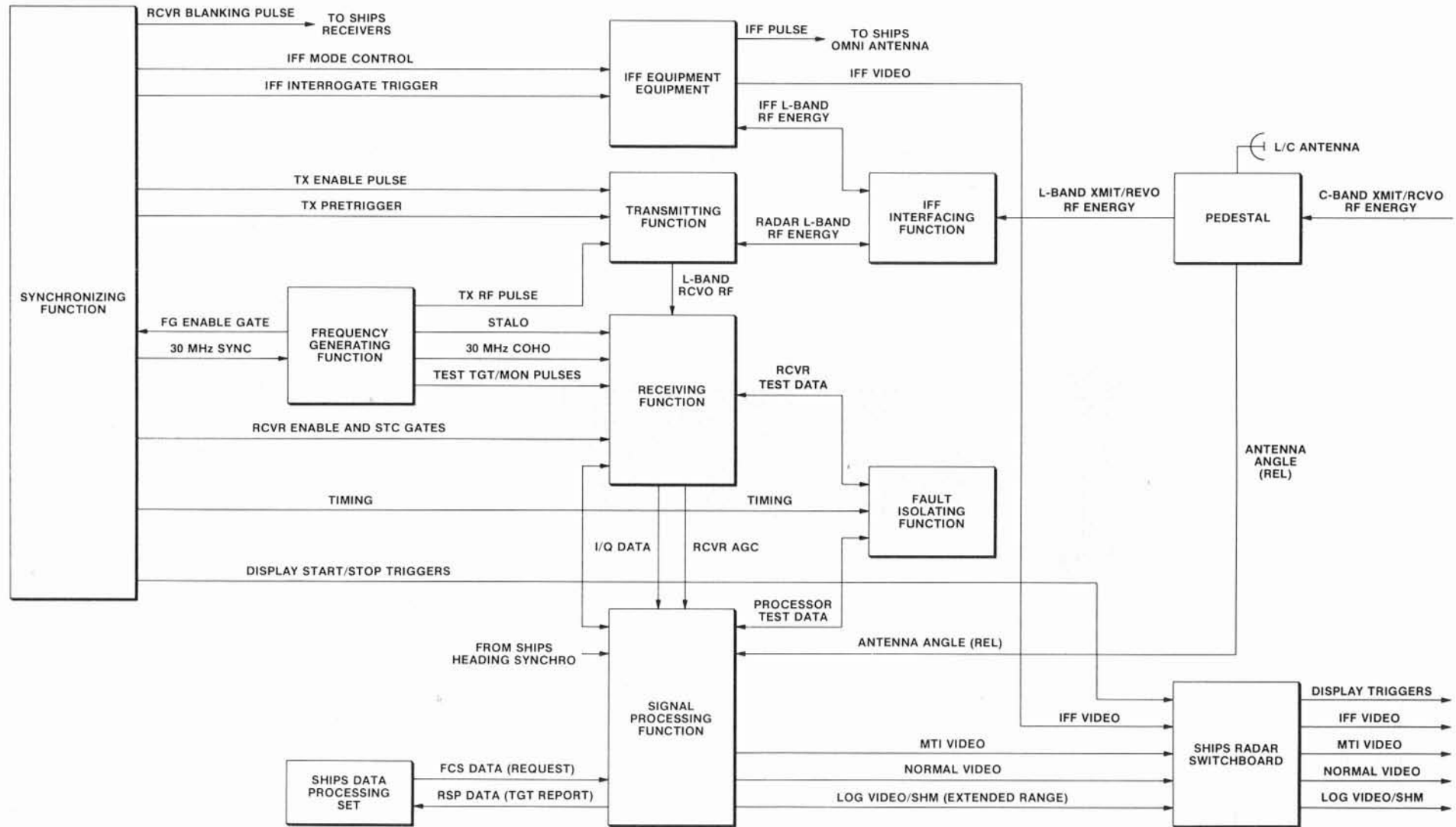

Figure 69. Radar Set SPS-65(V) 1 Functional Block Diagram

APPENDIX B

FREE

The software used to collect and analyze the data illustrated in this application note can be obtained free of charge. Fill out the request form below and mail it to Hewlett-Packard Co., 5301 Stevens Creek Boulevard, Santa Clara, California 95051, U.S.A. Attention Counters Product Manager.

Please answer all questions:

Check the business or industry in which you work?

- | | | |
|---|--|--|
| <input type="checkbox"/> Passive Components | <input type="checkbox"/> Systems | <input type="checkbox"/> Aerospace |
| <input type="checkbox"/> Tubes | <input type="checkbox"/> Microwave IC's | <input type="checkbox"/> Radio |
| <input type="checkbox"/> Test Instrumentation | <input type="checkbox"/> Transmission Components | <input type="checkbox"/> Radar |
| <input type="checkbox"/> Solid State Components | <input type="checkbox"/> Communications | <input type="checkbox"/> EW |
| <input type="checkbox"/> Amplifiers | <input type="checkbox"/> Weapons | <input type="checkbox"/> Other _____ (please specify) |

What is the area of your employment?

- | | | | |
|--|--|-----------------------------------|-----------------------------------|
| <input type="checkbox"/> Government | <input type="checkbox"/> Industrial/Commercial | <input type="checkbox"/> Military | <input type="checkbox"/> Academic |
| <input type="checkbox"/> Other _____ (please specify) | | | |

What best describes your job classification?

- | | | | |
|--|---------------------------------|--|--|
| <input type="checkbox"/> Advanced Research | <input type="checkbox"/> R & D | <input type="checkbox"/> Manufacturing | <input type="checkbox"/> Maintenance |
| <input type="checkbox"/> Calibration Lab | <input type="checkbox"/> Repair | <input type="checkbox"/> Field Service | <input type="checkbox"/> Other _____ (please specify) |

Check the frequency ranges in which you make measurements?

- | | | |
|---|--|---|
| <input type="checkbox"/> less than 100 MHz | <input type="checkbox"/> 101 MHz to 500 MHz | <input type="checkbox"/> 501 MHz to 1 GHz |
| <input type="checkbox"/> 1.1 GHz to 3 GHz | <input type="checkbox"/> 3.1 GHz to 12.5 GHz | <input type="checkbox"/> 12.6 to 20 GHz |
| <input type="checkbox"/> 20.1 GHz to 30 GHz | <input type="checkbox"/> 30.1 GHz to 60 GHz | <input type="checkbox"/> 60.1 GHz to 90 GHz |
| <input type="checkbox"/> 90.1 GHz to >110 GHz | <input type="checkbox"/> Other _____ (please specify) | |

IF THE SIGNALS ARE PULSED:

What is the minimum pulse width?

- | | | |
|--|--|--|
| <input type="checkbox"/> less than 10 ns | <input type="checkbox"/> 11 ns to 20 ns | <input type="checkbox"/> 21 ns to 50 ns |
| <input type="checkbox"/> 51 ns to 100 ns | <input type="checkbox"/> 101 ns to 1 μ s | <input type="checkbox"/> Other _____ (please specify) |

What is the maximum pulse width?

- | | | |
|--|--|--|
| <input type="checkbox"/> more than 20 ns | <input type="checkbox"/> 21 ns to 50 ns | <input type="checkbox"/> 51 ns to 100 ns |
| <input type="checkbox"/> 101 ns to 1 μ s | <input type="checkbox"/> 1.1 μ s to 1 ms | <input type="checkbox"/> 1 ms to 50 ms |
| <input type="checkbox"/> >51 ms | <input type="checkbox"/> Other _____ (please specify) | |

The modulation type present in the pulse is:

- | | | | |
|--------------------------------------|--------------------------------|---------------------------------|--|
| <input type="checkbox"/> FSK | <input type="checkbox"/> BPSK | <input type="checkbox"/> QPSK | <input type="checkbox"/> 8PSK |
| <input type="checkbox"/> 16QAM | <input type="checkbox"/> 64QAM | <input type="checkbox"/> 256QAM | <input type="checkbox"/> 1024QAM |
| <input type="checkbox"/> ASK | <input type="checkbox"/> AM | <input type="checkbox"/> FM | <input type="checkbox"/> M-ARY PSK |
| <input type="checkbox"/> OFFset QPSK | <input type="checkbox"/> QPR | <input type="checkbox"/> ON/OFF | <input type="checkbox"/> Other _____ (please specify) |

What IF frequency is used in modulating and demodulating the carrier?

- | | | |
|--|---|--|
| <input type="checkbox"/> 1 MHz to 20 MHz | <input type="checkbox"/> 21 MHz to 70 MHz | <input type="checkbox"/> 71 MHz to 140 MHz |
| <input type="checkbox"/> 141 MHz to 500 MHz | <input type="checkbox"/> 501 MHz to 2 GHz | <input type="checkbox"/> 2.1 to >3 GHz |
| <input type="checkbox"/> Other _____ (please specify) | | |

What bandwidth must your signals be contained within?

- | | | |
|---|---|--|
| <input type="checkbox"/> 1 MHz to 10 MHz | <input type="checkbox"/> 11 MHz to 30 MHz | <input type="checkbox"/> 31 MHz to 100 MHz |
| <input type="checkbox"/> 101 MHz to 500 MHz | <input type="checkbox"/> 501 MHz to 1 GHz | <input type="checkbox"/> 1.1 GHz to >2 GHz |

The required sensitivity for test instruments is:

- | | | |
|--|---|---|
| <input type="checkbox"/> +10 dBm to 0 dBm | <input type="checkbox"/> -1 dBm to -10 dBm | <input type="checkbox"/> -11 dBm to -25 dBm |
| <input type="checkbox"/> -26 dBm to -39 dBm | <input type="checkbox"/> -40 dBm to -59 dBm | <input type="checkbox"/> -60 dBm to -79 dBm |
| <input type="checkbox"/> -80 dBm to -100 dBm | | |

The maximum level required to test is:

- | | | |
|---|---|---|
| <input type="checkbox"/> 0 to +5 dBm | <input type="checkbox"/> +6 dBm to +15 dBm | <input type="checkbox"/> +16 dBm to +25 dBm |
| <input type="checkbox"/> +26 dBm to +35 dBm | <input type="checkbox"/> +36 dBm to +50 dBm | |

Name _____

Title _____

Company Name _____

Department _____

Address _____

Mail Stop _____

City _____

State/Zip Code _____

Country _____

Telephone _____