

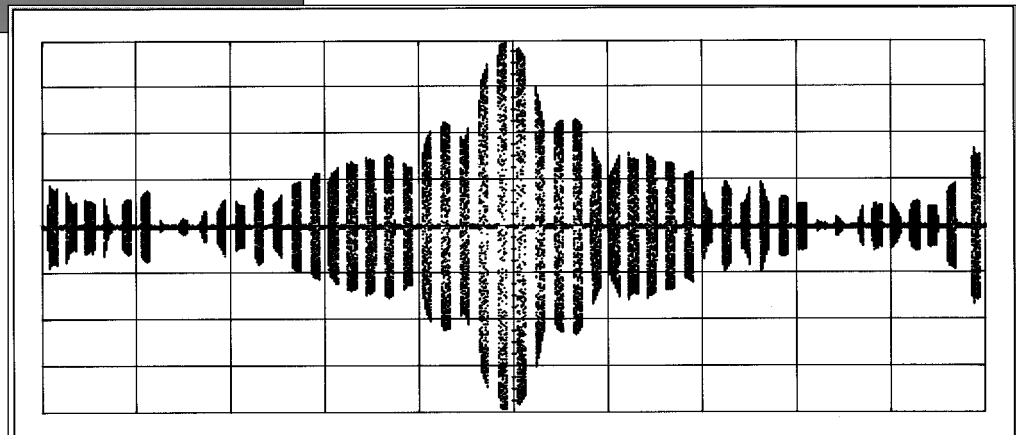

# Agilent PN 8360-3

## Generating Scan Modulation Patterns with the Agilent 8360

Product Note



**Agilent Technologies**

Innovating the HP Way

## Receiver Testing

Characterizing high-performance radar and EW receivers is a demanding application for any signal source. Historically, the signal sources used for these tests have been highly specialized and expensive systems. Now, with the 8360, Agilent Technologies offers a more economical approach to signal simulation. The 8360 Synthesized Sweeper is a general-purpose source with precision modulation capabilities allowing the user to simulate complex signals.

Better complex signal simulation is the result of excellent AM and pulse performance. Unlike other microwave sources whose AM and pulse performance capabilities are good when used individually, the full 8360 AM bandwidth and depth is typically available at any pulse width or rate.

This means that, in addition to the well-known AM, FM, and pulse modulation, the 8360 can also perform pulse-amplitude modulation (PAM) and a special version of PAM called scan modulation. Scan modulation is simultaneous, exponentially scaled amplitude and pulse modulation. One application for scan modulation is the simulation of an output antenna scan for a pulsed radar system, another is ECM receiver testing. A typical scan modulation waveform is shown in Figure 1.

This note provides an overview of a signal simulation system for scan modulation, and in doing so, will cover the significance of very deep AM and pulse performance with respect to the Automatic Leveling Control (ALC) loop. It specifically addresses the limitations inherent to ALC loops and what is done within the 8360 to eliminate the effects of these limitations on AM and pulse performance.

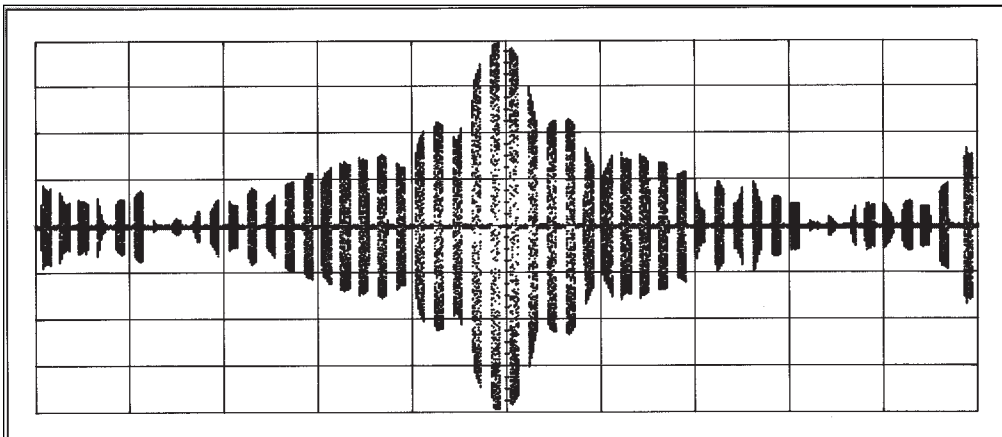

**Figure 1. In scan modulation, the amplitude modulated pulse train represents the pulsed signal of a radar.**

The scan modulation system shown in Figure 2 was used to create the plots in this note. The equipment used is as follows:

- 83620A Synthesized Sweeper (Option 006 Fast Pulse)
- 8770A Arbitrary Waveform Synthesizer or 3245A Universal Source
- 8112A Pulse Generator
- 11776A Waveform Generation Software
- HP 9000 Series 300 Desktop Computer
- 54120A Digitizing Oscilloscope Mainframe
- 54121A Four Channel Test Set

### Scan Modulation System – Theory of Operation

Scan modulation is simultaneous, exponentially scaled amplitude and pulse modulation. In the example configuration shown in Figure 2, the AM portion of the scan modulation pattern is generated by the Agilent 8770A arbitrary waveform generator using the Waveform Generation Language software (WGL).

Simultaneously, the 8360 is pulse modulated by a burst of pulses generated by the Agilent 8112A function generator. The results of these simultaneous modulation inputs may be similar to that shown in Figure 1. The ability to perform simultaneous modulation successfully depends on the capabilities of the Automatic Level Control (ALC) loop. At this point an understanding of the operation and the limitations of ALC systems will be helpful.

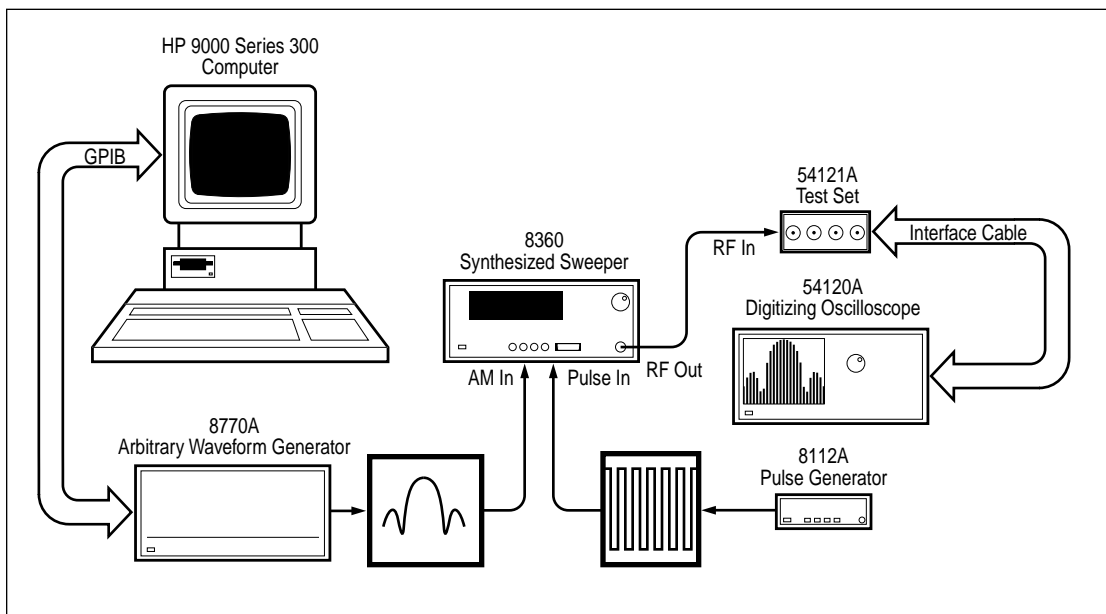

Figure 2. Scan modulation system block diagram

### Automatic Leveling System

In most broadband microwave sources, a system similar in Figure 3 is used for accurate control of output power and to provide amplitude modulation (AM) capability. Its basic operation involves sensing the output power with a detector and adjusting the level via a linear modulator. The difference between the detector voltage and the reference level is an error voltage. This error voltage is input to an integrator whose output controls the linear modulator. In steady-state operation, the error voltage is forced to zero.

With this system, amplitude modulation is possible by simply adding a modulating signal to the level reference voltage. The ALC loop will then force the RF amplitude to follow the input AM signal with good fidelity, within the dynamic range and bandwidth limitations of the ALC loop. For the 8360, pulse modulation can be performed simultaneously with AM by means of an additional modulator in the ALC loop and a switch in the loop integrator as shown in Figure 3. The loop integrator switch is closed during RF ON periods (during a pulse) and

is opened during RF OFF periods (between pulses) so that the integrator output is frozen while the RF is off, but functions normally while the RF is on. This allows the ALC loop to control the RF amplitude without disruption while pulse modulation is occurring.

### Amplitude Modulation

AM, when referred to in the context of scan modulation, is the resulting modulation seen by a receiver due to a scanning antenna. Since this pattern can have significant modulation depth, it is desirable to be able to modulate any simulation signal as close to 100%, a modulation index (M)<sup>1</sup> of 1.0, as possible.

On the Agilent 8360 there are two AM modes, Standard mode with 20 dB (90%) AM modulation depth and Deep AM mode with 50 dB (99.7%) AM modulation depth. For both modes, the input sensitivity can be set to have either linear (100%/V) or logarithmic (10 dB/V) scaling.

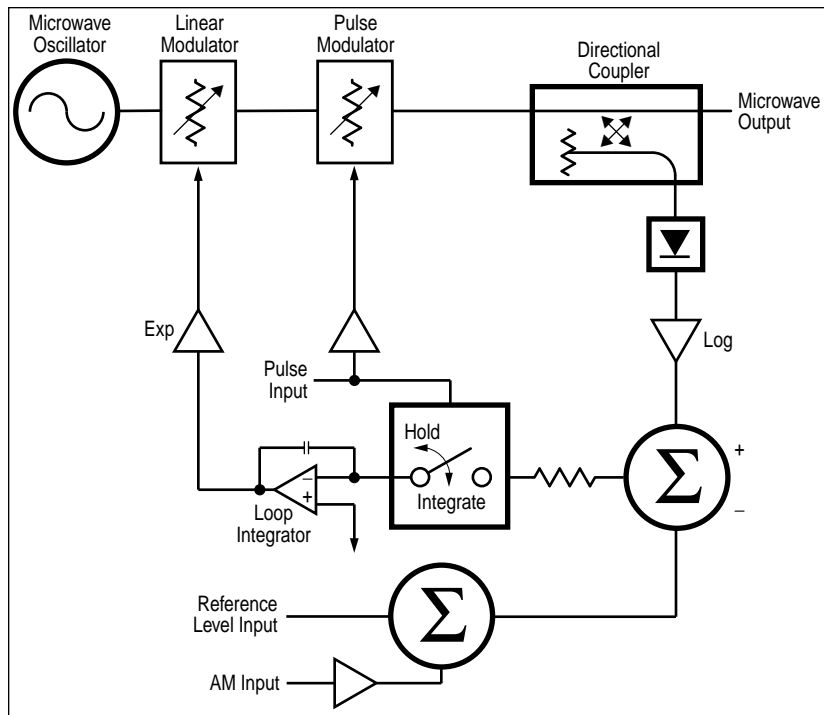

**Table 1.**

In antenna applications, AM depth is often described in logarithmic rather than linear terms since this makes dealing with antenna calculations much simpler.

Modulation Index (M)	dB Depth $-20\text{LOG}(1-M)$
0.997	50 dB
0.99	40 dB
0.90	20 dB
0.80	14 dB
0.70	10.5 dB
0.60	8 dB
0.50	6 dB

1. A measure of the amount of modulation is the modulation index M. It is often referred to as percentage modulation.

## AM Limitations – Deep AM

On most signal sources, AM depth is restricted by ALC range limitations. If the modulator has greater usable dynamic range than the amplitude sensing circuitry, that range cannot be fully utilized for AM. In a typical case, the maximum power available from the RF hardware is +10 dBm and the RF amplitude cannot be sensed accurately below -10 dBm, so the full ALC range is 20 dB. Attempting AM depth greater than 20 dB would result in significant AM distortion, even if a modulator with 90 dB of dynamic range were used.

A solution to this problem is provided by the Deep AM mode of the 8360. Deep AM mode offers reduced distortion for very deep AM, as shown in Figure 4. Since the 8360's linear modulator and drive circuits have been designed with good linearity to minimize ALC loop gain variations, they can provide AM with very little distortion, even without the error correcting action of the feedback loop.

While Standard AM mode on the 8360 is DC-coupled and feedback leveled, Deep AM mode is feedback leveled only at ALC levels above -13 dBm. For ALC levels below -13 dBm, the output is DC-controllable, but is not feedback leveled.<sup>2</sup> By DC-controlling rather than feedback leveling the output at low levels it is possible to overcome the limitations associated with the ALC loop and avoid the distortion associated with overmodulating the source.

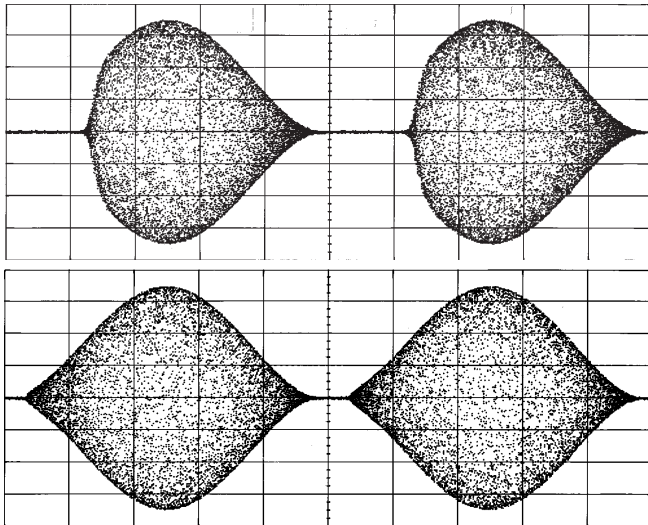

There are two limitations associated with disconnecting the feedback loop at low levels. First, the output of the Sample-and-Hold (S/H) circuit, represented by the switch-integrator combination in Figure 3, may drift with time due to leakage currents. Secondly, the slope of the linear modulator response can vary with frequency.

Sample-and-Hold drift is a concern at slow AM rates where the signal level remains below -13 dBm for prolonged periods. Drift for slow AM rates can be minimized by using the Low ALC Bandwidth mode of operation on the 8360. This mode decreases the ALC bandwidth by switching a larger capacitor into the integrator circuit, which proportionally reduces the effects of leakage currents on the output of the S/H circuit.

The frequency response of the linear modulator is automatically corrected when the ALC loop is closed. But with the ALC loop open, the modulation accuracy is entirely dependent on modulator linearity. The frequency response of the modulator at a CW frequency can be very accurately characterized by using the 8360 AM Bandwidth Calibration feature.

2. DC-controlling the output power rather than feedback leveling results in a typical sample-and-hold drift of 0.25 dB/second for a "High" ALC bandwidth and 0.025 dB/second drift with a "Low" ALC bandwidth.

**Figure 4. The benefits of Deep AM can be observed by looking at the same sinusoidally modulated signal as it is generated from a source with 20 dB AM depth and again with 50 dB AM depth.**

## Pulse Modulation

Narrow pulses with fast rise/fall times are necessary to characterize some receivers. For these receivers the 8360 Option 006 provides less than 10 ns rise/fall times without affecting other critical pulse performance specifications like on/off ratio, minimum pulse width, and pulse repetition frequency.

## Leveling Narrow Pulses

A key concern in very narrow pulses is poor level accuracy due to the limitations within ALC loops. With narrow pulses, the output of the ALC log amp into the Sample-and-Hold (S/H) control will not have enough time to reach the proper value for the specific power input. This results in an S/H output smaller than it would be in CW mode. Typically ALC circuits respond to the reduced S/H output by raising the RF output power until the voltage from the S/H is what it “should” be. As pulses become too narrow, their amplitude grows. This is the reason for poor leveling accuracy with very narrow pulses. A solution to this generic ALC limitation is provided by “Search Mode” on the 8360.

## Search Mode

Narrow pulse level accuracy problems may be avoided by simply not trying to level them. The 8360 has two unlevelled modes: ALC Off and Search. In ALC Off Mode, the modulator drive can be controlled from the front panel to vary the quiescent

RF output level. In Search Mode, the instrument microprocessor momentarily closes the ALC loop and searches out the correct output power level. It then maintains that modulator drive setting to hold the output power level constant.

Neither of these modes is feedback leveled. The unlevelled modes allow the user to control the linear modulator directly and removes ALC bandwidth limitations. Since the setting of the modulator does not change with pulse width, the pulse amplitude remains constant as the pulses are narrowed. Search mode pulses as narrow as 20 ns may be produced on the 8360 Option 006.

The sequence of steps that occur when Search Mode is selected are:

1. All modulation is disabled and the ALC loop is closed to provide a calibrated reference power.
2. The output power is measured using the internal coupler/detector.
3. The ALC system is disabled.
4. While monitoring the internal detector, the RF modulator level is varied until the detected power is equivalent to the reference power measured in 2.
5. Modulation is re-enabled when appropriate.
6. This search automatically occurs with each power level entry or frequency change and requires about 200 ms to be completed.

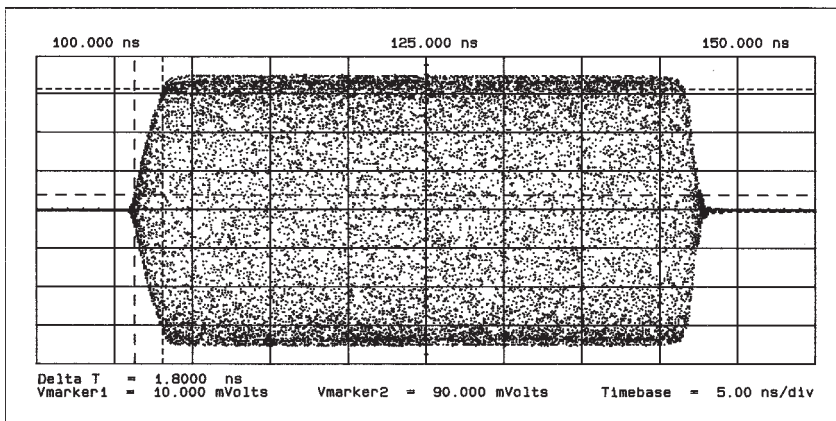

**Figure 5.** Option 006 enables the 8360 to specify better than 10 ns pulse rise/fall time performance.



## Summary

The modulation features of the 8360 Synthesized Sweeper combine to create an excellent flexible signal source platform. Scan modulation pattern generation is an example of complex modulation that places stringent demands on a signal source. The Deep AM and Search Mode features of the 8360 can be combined to produce an amplitude modulated pulse train with 50 dB AM depth and pulse widths as narrow as 20 ns. These capabilities, combined with the AM Bandwidth Cal and Low ALC Bandwidth accuracy enhancement features, complement the overall modulation performance of the Agilent 8360.

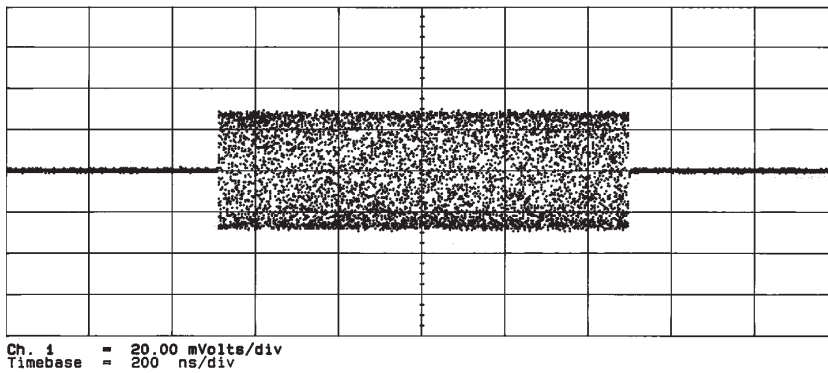

Figure 6. A 1 us wide pulse

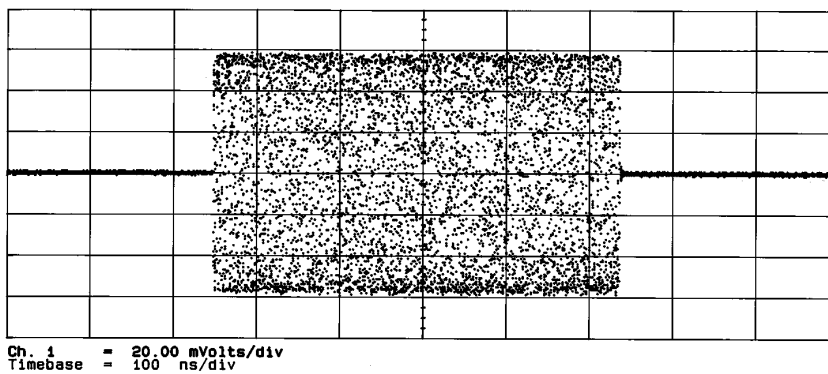

Figure 7. A 500 ns wide pulse. Without Search Mode, as the pulse is made very narrow, the amplitude grows dramatically.

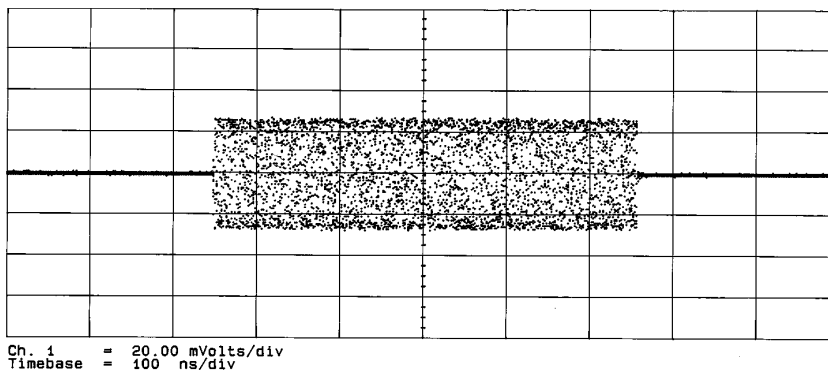

Figure 8. The same pulse as shown in Figure 7 using Search mode. Note that the amplitude returns to the original (and correct) level shown in Figure 6.

**Agilent Technologies' Test and Measurement Support, Services, and Assistance**

Agilent Technologies aims to maximize the value you receive, while minimizing your risk and problems. We strive to ensure that you get the test and measurement capabilities you paid for and obtain the support you need. Our extensive support resources and services can help you choose the right Agilent products for your applications and apply them successfully. Every instrument and system we sell has a global warranty. Support is available for at least five years beyond the production life of the product. Two concepts underlie Agilent's overall support policy: "Our Promise" and "Your Advantage."

**Our Promise**

"Our Promise" means your Agilent test and measurement equipment will meet its advertised performance and functionality. When you are choosing new equipment, we will help you with product information, including realistic performance specifications and practical recommendations from experienced test engineers. When you use Agilent equipment, we can verify that it works properly, help with product operation, and provide basic measurement assistance for the use of specified capabilities, at no extra cost upon request. Many self-help tools are available.

**Your Advantage**

"Your Advantage" means that Agilent offers a wide range of additional expert test and measurement services, which you can purchase according to your unique technical and business needs. Solve problems efficiently and gain a competitive edge by contracting with us for calibration, extra-cost upgrades, out-of-warranty repairs, and on-site education and training, as well as design, system integration, project management, and other professional services. Experienced Agilent engineers and technicians worldwide can help you maximize your productivity, optimize the return on investment of your Agilent instruments and systems, and obtain dependable measurement accuracy for the life of those products.

By internet, phone, or fax, get assistance with all your test and measurement needs.

**Online Assistance**

[www.agilent.com/find/assist](http://www.agilent.com/find/assist)

**Phone or Fax**

United States:

(tel) 1 800 452 4844

Canada:

(tel) 1 877 894 4414

(fax) (905) 206 4120

Europe:

(tel) (31 20) 547 2323

(fax) (31 20) 547 2390

Japan:

(tel) (81) 426 56 7832

(fax) (81) 426 56 7840

Latin America:

(tel) (305) 269 7500

(fax) (305) 269 7599

Australia:

(tel) 1 800 629 485

(fax) (61 3) 9272 0749

New Zealand:

(tel) 0 800 738 378

(fax) (64 4) 495 8950

Asia Pacific:

(tel) (852) 3197 7777

(fax) (852) 2506 9284

Product specifications and descriptions in this document subject to change without notice.

Copyright © 1990, 2000 Agilent Technologies

Printed in U.S.A. 7/00

5091-0226E



**Agilent Technologies**

Innovating the HP Way