

Product Note 8510-2

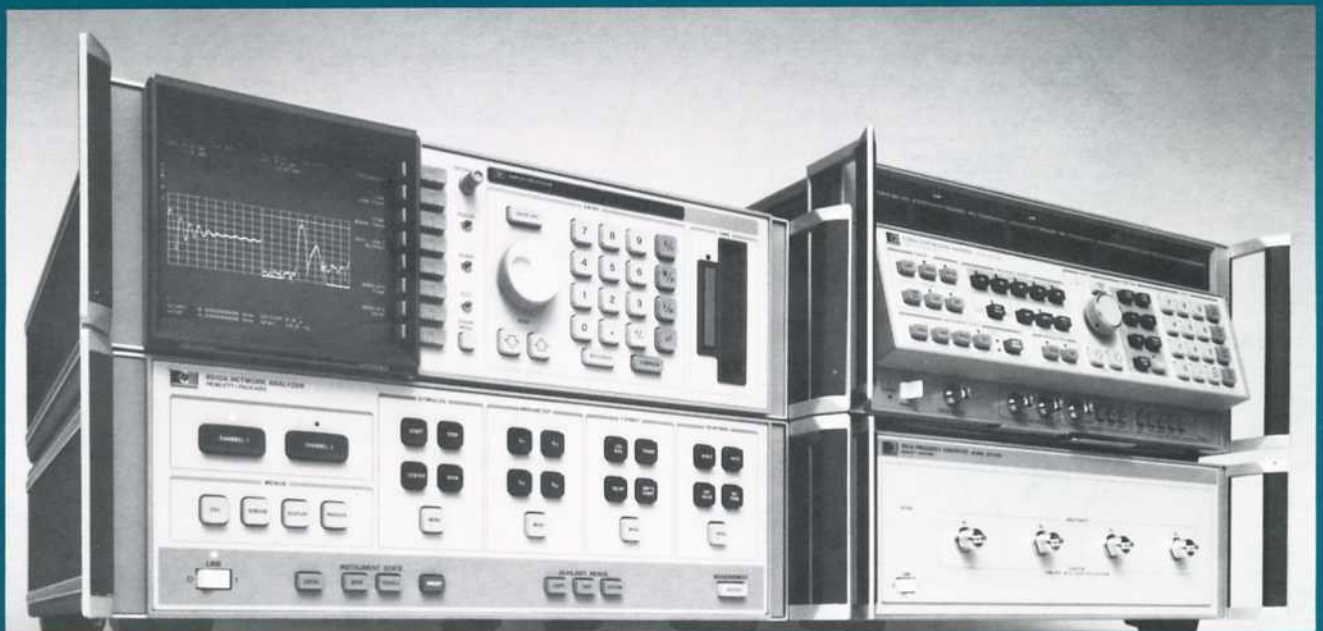

Radar Cross-Section Measurements
Using the HP 8510 Network Analyzer
to make radar cross-section measurements

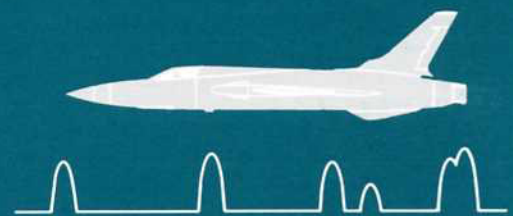

Introduction

A major problem encountered when making radar cross-section (RCS) measurements is the need to remove the effects of unwanted signals from the measurement data. For this reason, measurements are often conducted in an anechoic chamber that can absorb the energy incident on the walls, floor, and ceiling. However, even the most carefully designed chamber will allow some residual reflections and leakage between the transmit and receive antennas to remain. These unwanted signals limit the absolute accuracy of the measurement, but by using careful calibration techniques, they can be eliminated from the measurement results.

The HP 8510 network analyzer can be configured to make swept frequency RCS measurements in the frequency domain and perform the required corrections automatically. The internal error correction capability of the analyzer can be used to remove measurement errors at a speed that allows real-time measurements of the test target. In addition, the HP 8510 also has the optional capability to compute the inverse Fourier Transform of the measured data to give the time domain response, which displays reflections from the target as a function of time or distance. The time domain response gives great insight into where in the range the reflections occur. The time domain gating feature can also be used to analyze the measured responses and further reduce the effects of unwanted signals. This note outlines these swept frequency measurement and calibration procedures and describes the results of using the HP 8510 to make swept frequency RCS measurements inside an anechoic chamber.

RCS Measurement Block Diagram

In radar cross-section (RCS) measurements, the response of a target is analyzed by bouncing radar signals off the target and picking up the return signals with a receive antenna. With the HP 8510, any leakage between the radar transmit and receive antennas can be removed by measuring the chamber when empty and subtracting these results taken with the target in place.

The HP 8510 network analyzer consists of the HP 8510A, a swept signal source (HP 8340A, 8341A, or 8350A), and a test set. Of the five test sets available, the best choice for a dedicated RCS system is the HP 8511A frequency converter, a general purpose, four-input, phase-locked receiver that measures from 45 MHz to 26.5 GHz. This test set provides the most flexibility and the greatest dynamic range. (However, as will be shown, each of the other test sets can also be configured to make RCS measurements.) The general HP 8510 RCS configuration with the HP 8511A is shown in Figure 1. With this configuration, displaying $S_{11}(b_1/a_1)$ gives the RCS response of the target.

The HP 8510A controls both the source and the test set via the HP 8510 system bus. The HP 8511A is also connected to the HP 8510A by an analog interconnect cable. An HP 9000 series 200 controller is connected via HP-IB*. Refer to the HP 8510A Operating and Programming Manual¹ for details on operating the HP 8510.

* HP-IB is Hewlett-Packard's hardware, software, documentation, and support for IEEE-488 and IEC-625, worldwide standards for interfacing instruments.

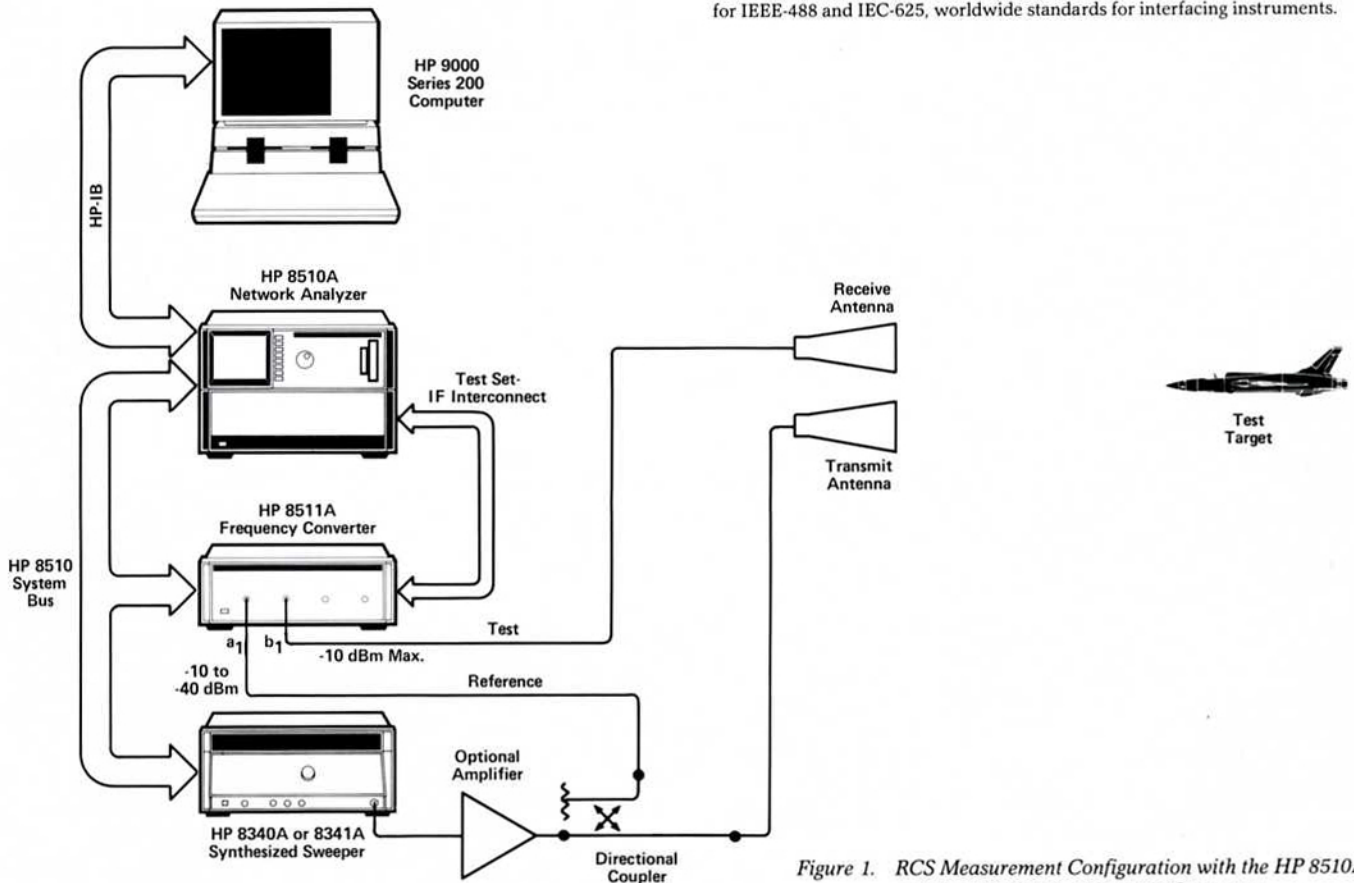

Figure 1. RCS Measurement Configuration with the HP 8510A and the HP 8511A Frequency Converter.

Correcting for Measurement Errors

There are two main categories of systematic errors in the RCS measurement. The first (isolation), which causes an error signal to arrive in parallel with the main signal reflected from the target, is due to the residual reflections within the room and the leakage between the transmit and receive antennas. The second (response), which causes an error in the magnitude and phase of the measured signals, is the tracking error between the test and reference measurement channels. A flow graph depicting these errors is shown in Figure 2.

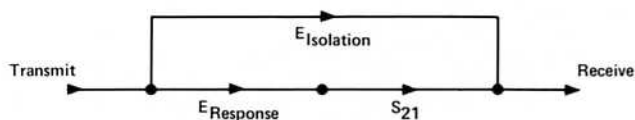

Figure 2. Error Model for RCS Measurement.

Removing the Isolation Error Using Trace Math

A simple way to remove the effects of the isolation error is to use trace math to subtract out the effects of the room. This vector subtraction can be performed on either frequency domain or time domain traces. The procedure is to measure the S_{21} response of the room, store the frequency domain and/or time domain traces into one of the HP 8510 memory registers, position and measure the target, and then use the trace math feature to display data-minus-memory. (The subtraction of time domain traces is meaningful only when the start and stop times of both the measured and stored traces are the same.)

The advantage of this technique is its simplicity and speed, and it can be used to give a quick representation of the test target. However, the trace math technique has several limitations. The frequency response error is not removed, and therefore no amplitude and phase (or time) reference is obtained. The trace math technique also limits the effectiveness of the time domain gating feature, because the HP 8510 gating operation occurs prior to the trace math operation and therefore cannot (with this technique) be used to analyze the corrected responses.

RCS Error Correction Using the 1-Port Calibration Model

A better method to perform the RCS error correction uses the internal calibration capabilities of the HP 8510 (and an external controller). The built-in error models were optimized for making network measurements but may also be used to perform the error correction required for RCS measurements. Unlike the trace math approach, the proper application of these error models will correct the measured data for both error terms (isolation and response) and permit both time domain and trace math operations to be performed on the error corrected data. The most effective RCS calibration procedure utilizes the S_{11} 1-port error model, which can be drawn as shown in Figure 3.

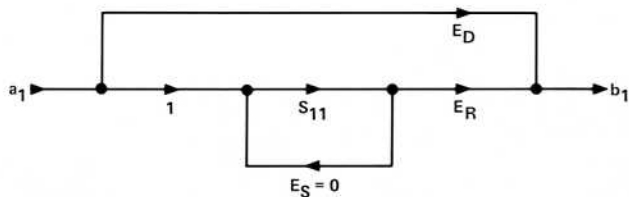

Figure 3. 1-Port Error Model Used for RCS Calibration.

The error terms E_D , E_R , and E_S are directivity, reflection tracking, and source match, respectively, associated with the 1-port return loss measurement. In the RCS application, the E_D error term is used to model the empty room (isolation), and the E_R error term is used to model the reference target (response). The E_S error term (source match) is not used (set equal to zero). To perform the calibration, first measure the RCS response of the reference target. Next, measure the empty room with the reference target removed but the reference target mount still in place, and then subtract the two results to give the E_R error term. Finally, replace the reference target mount with the test target mount (if different), and re-measure the empty room. This response gives the E_D error term.

This 1-port RCS error correction procedure gives a true isolation-response calibration (compare Figure 3 to Figure 2). The effects of reflections within the room are subtracted from the measured data and the tracking error is normalized out. Because the error correction is applied using an internal calibration routine, the time domain operation is performed on the corrected data. Therefore the gating (and trace math) features of the HP 8510 can be used to further analyze the corrected RCS responses.

The only disadvantage of the 1-port RCS calibration procedure is its reliance on an external controller to construct the calibration set. (A BASIC program for the 1-port RCS calibration procedure written for the HP 9000 series 200 controller is included in the appendix.) However, after the calibration set is stored in the HP 8510A, the external controller is no longer needed in the measurement.

Measurement Speed

With the HP 8340A (or 8341A) as the source, the HP 8510 can be operated in either a ramp sweep or a (synthesized) stepped sweep mode (the HP 8350 operates only in ramp sweep). The ramp sweep mode is fast enough to make real-time measurements: for a 401 point measurement using ramp sweep with error correction and time domain both turned on, the trace update time is approximately 700 ms. The stepped sweep mode is slower (50 ms per point), but it provides improved frequency stability that results in more accurate measurements and greater dynamic range. And in the stepped sweep mode, an averaging factor of up to 128 can be used without significantly slowing down the trace update time. The benefit of averaging is a reduction in the system noise floor proportional to the square root of the averaging factor. (Averaging should always be used during calibration.)

Time Domain RCS Responses

For RCS time domain measurements, the HP 8510 bandpass mode is used. This gives the response of the target to an RF burst with an impulse shaped envelope. The width of the impulse, which translates into response resolution, is determined by the bandwidth of the measurement: the wider the measurement bandwidth, the narrower the impulse width and better the resolution. The maximum window is used to reduce the time domain impulse sidelobes to give the maximum time domain dynamic range.

Another consideration in RCS measurements is called the alias-free range. Because the frequency domain data is taken at discrete frequencies, there are periodic repetitions (called aliasing) in the time domain response. The spacing between these repetitions is the time domain range, equal to the reciprocal of the frequency sampling interval. The narrower the spacing between frequency data points, the larger the alias-free range. In this measurement, 401 points of data taken over a 4 GHz bandwidth, the alias-free range is 100 ns (30 m).

(Refer to reference 1 for a detailed description of the time domain bandpass mode, windowing, resolution, and range.)

RCS Measurement Results

The following figures display the results of using the RCS block diagram of Figure 1 to make swept RCS measurements inside an anechoic chamber. The HP 8511A was positioned inside the chamber close to the transmit and receive antennas, and the HP 8510A and 8340A were connected 20 feet away outside the chamber. The transmit and receive antennas were approximately 10 feet above the ground and 3 feet apart. A divider of RF-absorptive material was located between the two antennas to reduce the leakage signal level. The target was mounted on a foam target positioner located 16 feet from the antennas. The measurements were made using the stepped sweep mode with 401 points and an averaging factor of 256 (trace update time of 42 seconds).

RCS Measurement of an Empty Anechoic Chamber

The uncorrected frequency domain and time domain responses of the empty anechoic chamber are shown in Figure 4. The frequency domain response shows that the isolation of the chamber varies with frequency and degrades significantly at the low end. This degradation in isolation is due primarily to the increased leakage between the antennas at low frequencies because of the reduced effectiveness of the RF shielding between them.

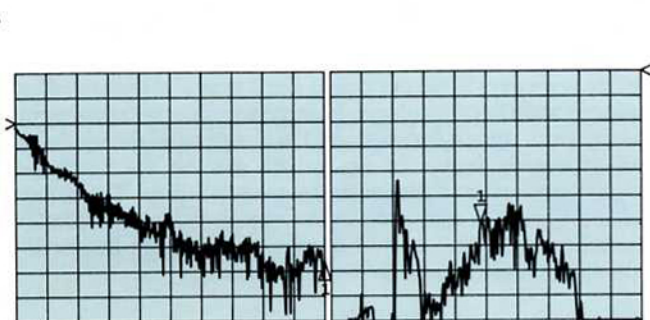
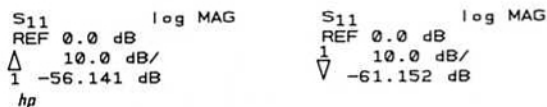

START 0.60000000 GHz CENTER 40.0 ns
STOP 4.60000000 GHz SPAN 100.0 ns

Figure 4. Uncalibrated RCS Frequency and Time Domain Responses of the Empty Anechoic Chamber.

The right half of Figure 4 shows the time domain response which displays the isolation of the chamber as a function of time (or distance). The first major response shows the leakage path between the transmit and receive antennas. The other responses, which arrive later in time, are due to reflections from the anechoic material on the floor, ceiling, and walls. The marker indicates the location of the target positioner.

RCS Measurement of a Metal Sphere

The uncorrected RCS responses of a 12-inch diameter metal sphere used as a test target are shown in Figure 5. The frequency domain response is relatively flat except at the low end where the received signal is dominated by the response of the chamber. The time domain response is essentially identical to that of the empty chamber (Figure 4) except for the added response of the sphere (indicated by the marker).

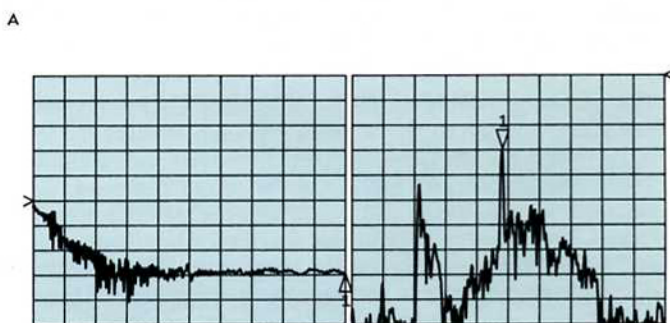
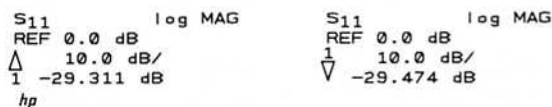

START 0.60000000 GHz CENTER 40.0 ns
STOP 4.60000000 GHz SPAN 100.0 ns

Figure 5. Uncalibrated RCS Frequency and Time Domain Responses of a Metal Sphere.

When trace math is used to subtract out the effects of the chamber from the measurement of the sphere (Figure 5 minus Figure 4), the responses of Figure 6 result. This vector subtraction greatly reduces the effects of the unwanted leakage and reflection paths from the measurement, and the subtracted frequency domain response of the sphere has significantly less noise and no longer rolls up at the low end.

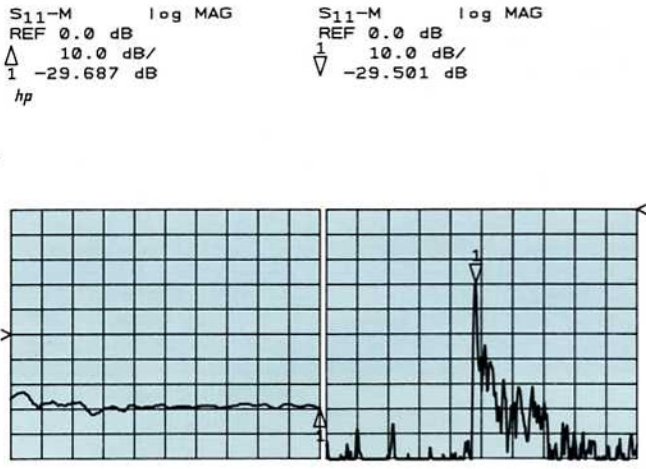

START 0.600000000 GHz CENTER 40.0 ns
 STOP 4.600000000 GHz SPAN 100.0 ns

Figure 6. RCS Frequency and Time Domain Responses of the Sphere Using Trace Math to Subtract Out the Effects of the Room.

The time domain response clearly shows the cancellation of the error responses of the room. The marker indicates the main reflection from the front surface of the sphere. The leakage and reflection responses that arrive in time before the response of the sphere are effectively eliminated, and the lower responses that follow are due primarily to energy reflected from the sphere not being completely absorbed by the anechoic material. A second effect is the shadowing of the back wall by the sphere. This "backshadowing" occurs because the amount of energy incident on the back wall of the chamber is lower with the target in place than when it is removed. This makes the subtraction of the room less effective in the region behind the test target. These residual reflections and the frequency response of the system comprise the remaining measurement errors. Since trace math was used in this example to remove the errors, the gating feature cannot be used to further analyze these (partially) corrected responses.

Calibrated RCS Measurement of a Metal Sphere

To make a calibrated RCS measurement of the sphere using the 1-port RCS calibration procedure, a separate target must be used as reference to correct for the frequency response error of the measurement system. Figure 7 shows the frequency and time domain responses of a 3-inch diameter, hemispherical-ended brass cylinder (turned broadside). This target gives a large reflection that rolls up slightly with frequency and is 8 to 10 dB larger in amplitude than the measured response of the sphere. In the following measurements, except where noted, the 1-port RCS calibration procedure is employed using the broadside cylinder as the reference target.

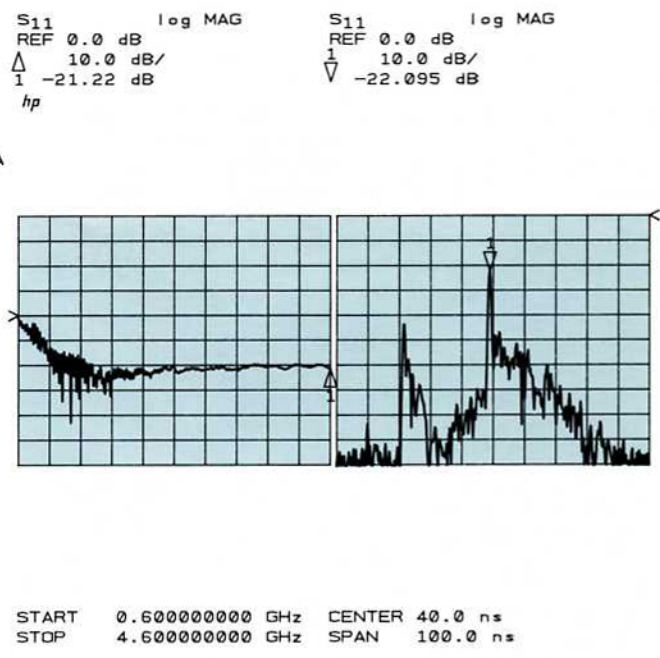

Figure 7. Uncalibrated RCS Frequency and Time Domain Responses of a Broadside Brass Cylinder.

The calibrated frequency and time domain responses of the metal sphere are shown in Figure 8. Notice that the effects of the isolation and response errors are greatly reduced. The time domain response shows two main reflections from the sphere. The first response is due to specular reflection from the front surface of the sphere, and the second lower response is due to a "wrap-around wave" that reflects from the back of the sphere. These two reflections account for the ringing that occurs in the frequency domain response. The slight downward slope of the frequency response of the sphere is due to the upward slope in the frequency response of the reference target (Figure 7). The remaining low level noise on the trace is caused by the residual reflections within the room and the backshadowing of the wall behind the target.

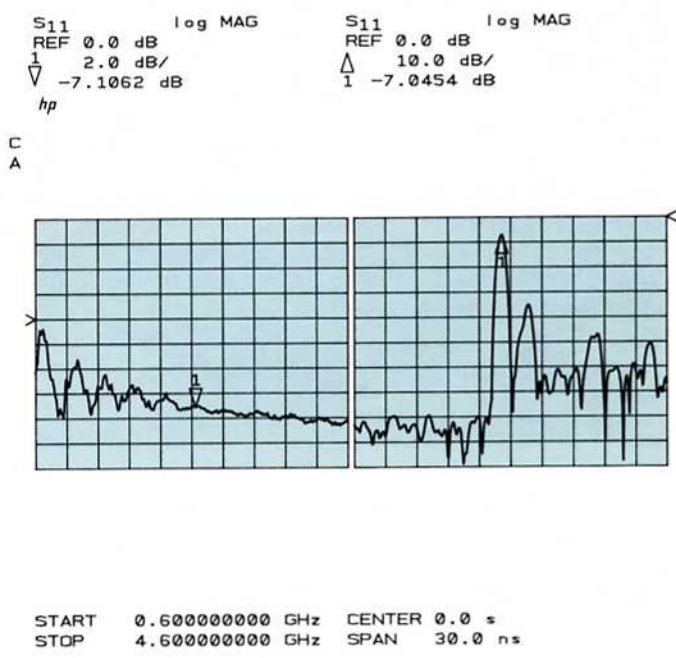

Figure 8. Calibrated RCS Frequency and Time Domain Responses of a Metal Sphere Using the 1-Port RCS Calibration Procedure.

Using Gating to Analyze the RCS Responses

The HP 8510 gating feature can be used to further reduce the effects of these residual reflections. A gate is a bandpass shaped time filter that can be used to selectively view the effects of individual portions of the time domain response. In converting back to the frequency domain, only the effects of the reflections inside the gate are viewed. In Figure 9, the gate span is set to include both main reflections from the sphere. With the gate turned on, the effects of the reflections outside the gate are removed, and the result is a very smooth frequency domain response that very closely follows the shape of the ungated response but has significantly less noise.

```

S11          log MAG          S11          log MAG
REF 0.0 dB          REF 0.0 dB
1  2.0 dB/          Δ  10.0 dB/
▽ -7.0171 dB          1  -7.0454 dB
hp
    
```

```

C
A GATE SPAN
  7.0 ns
G 2.0985 m
    
```

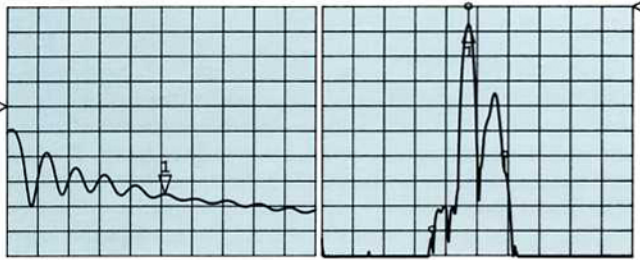

```

START 0.600000000 GHz CENTER 0.0 s
STOP  4.600000000 GHz SPAN  30.0 ns
    
```

Figure 9. Gated Frequency and Time Domain RCS Responses of the Metal Sphere.

The HP 8510 gating feature can also be used to analyze the effects of individual reflections from the target. In Figure 10, the gate span is reduced to include only the first response of the sphere. This specular reflection should be flat with frequency, but the observed roll-off is due to the unflatness in the frequency response of the reference target. However, this trace can be saved into a memory register and the data-divided-by-memory trace math feature used to correct the measured traces for the roll-off.

```

S11          log MAG          S11          log MAG
REF 0.0 dB          REF 0.0 dB
1  2.0 dB/          Δ  10.0 dB/
▽ -7.187 dB          1  -7.0452 dB
hp
    
```

```

C
A GATE SPAN
  1.5 ns
G 449.69 mm
    
```

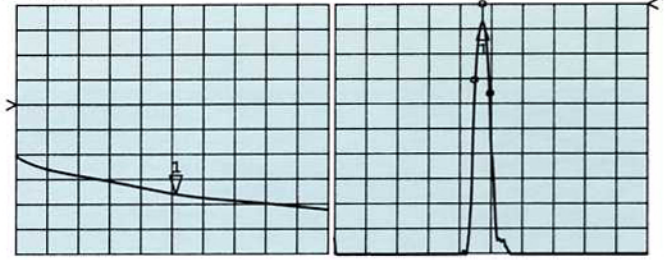

```

START 0.600000000 GHz CENTER 0.0 s
STOP  4.600000000 GHz SPAN  30.0 ns
    
```

Figure 10. Effect of Reducing the Gate Span to Analyze the First Time Domain Response of the Sphere.

The response of the sphere in Figure 11 exercises the full capability of the HP 8510 in RCS measurements. The 1-port RCS calibration procedure is used to remove the errors due to the isolation of the anechoic chamber and the response of the measurement system (Figure 8). Gating is used to further remove the effects of the residual reflections and isolate the responses of the sphere (Figure 9). Finally, trace math is used to remove the roll-off (Figure 10) due to the reference target. The resulting frequency domain response (Figure 9 divided by Figure 10) is very close to the theoretical RCS response of the sphere.

```

S11/M        log MAG          S11          log MAG
REF 0.0 dB          REF 0.0 dB
1  1.0 dB/          Δ  10.0 dB/
▽ 0.1667 dB          1  -7.0454 dB
hp
    
```

```

C
A
G
    
```

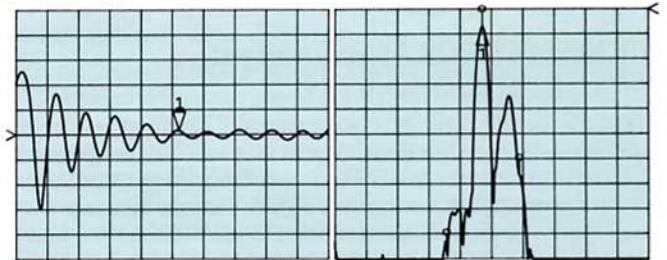

```

START 0.600000000 GHz CENTER 0.0 s
STOP  4.600000000 GHz SPAN  30.0 ns
    
```

Figure 11. Effect of Using Calibration, Gating, and Trace Math to Analyze the RCS Responses of the Sphere.

Using Different Reference Targets

The following measurements will use the 1-port RCS calibration procedure with different reference targets to measure the brass cylinder as the test target. When the broadside cylinder is used as reference target, its corrected RCS response is flat with frequency at 0 dB and 0 degrees phase. However, when the cylinder is rotated 90° (end-on), the responses of Figure 12 result. The time domain response reveals that there are two major reflections from the cylinder, one from each end. These two reflections are very close in amplitude, which accounts for the high degree of ripple in the frequency domain response. The gate span is set to include only the reflections from the target, and because these responses are so far above the noise floor, the gated responses (the dark traces) are little different from the ungated responses.

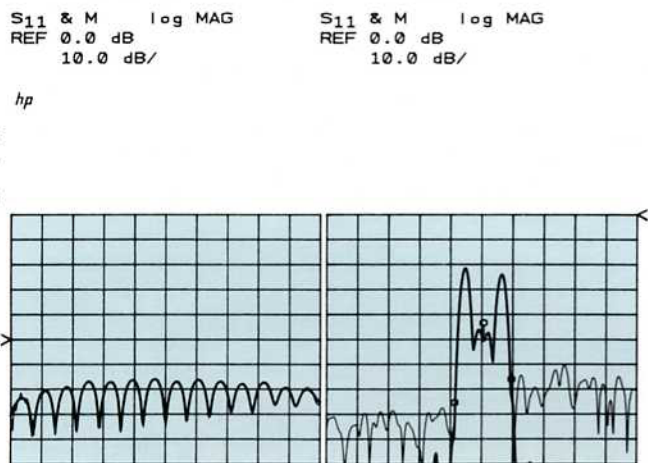

Figure 12. Gated and Ungated RCS Responses of the Brass Cylinder Turned End-on with the Broadside Cylinder Used as Reference.

Figure 13 shows the same measurement made using the metal sphere as reference target. In this case, the overall amplitude of the response is higher because it is referenced to a smaller target. In addition, small variations occur because of the differences in frequency response between the two reference targets. As before, the target responses are still far enough above the time domain noise floor that the gated responses (dark traces) are little different from the ungated responses.

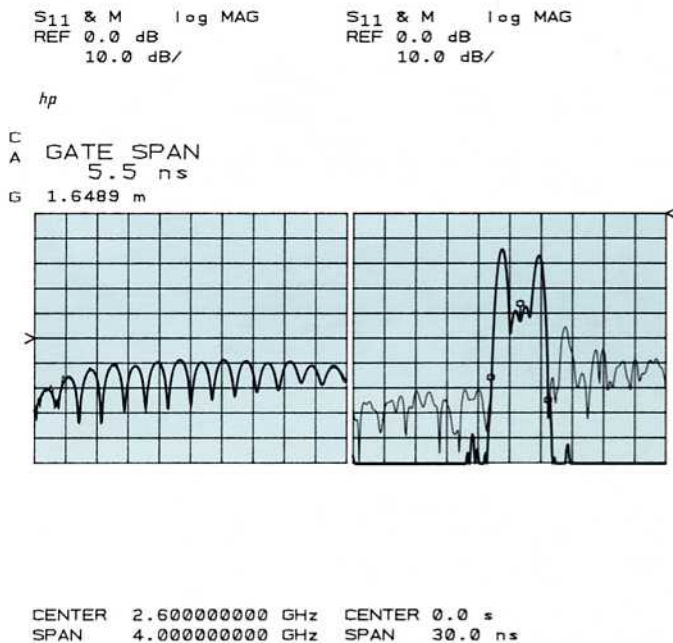

Figure 13. Gated and Ungated RCS Responses of the Brass Cylinder Turned End-on with the Metal Sphere Used as Reference.

Measurement of a Small RCS Target (of Styrofoam)

As an example of a measurement of a very small radar cross-section, Figure 14 shows the uncorrected responses of a 3-inch diameter column of styrofoam. The frequency and time domain responses are very similar to those of the empty room (Figure 4), and the response of the target (indicated by the marker) is almost completely lost in the background clutter of the chamber.

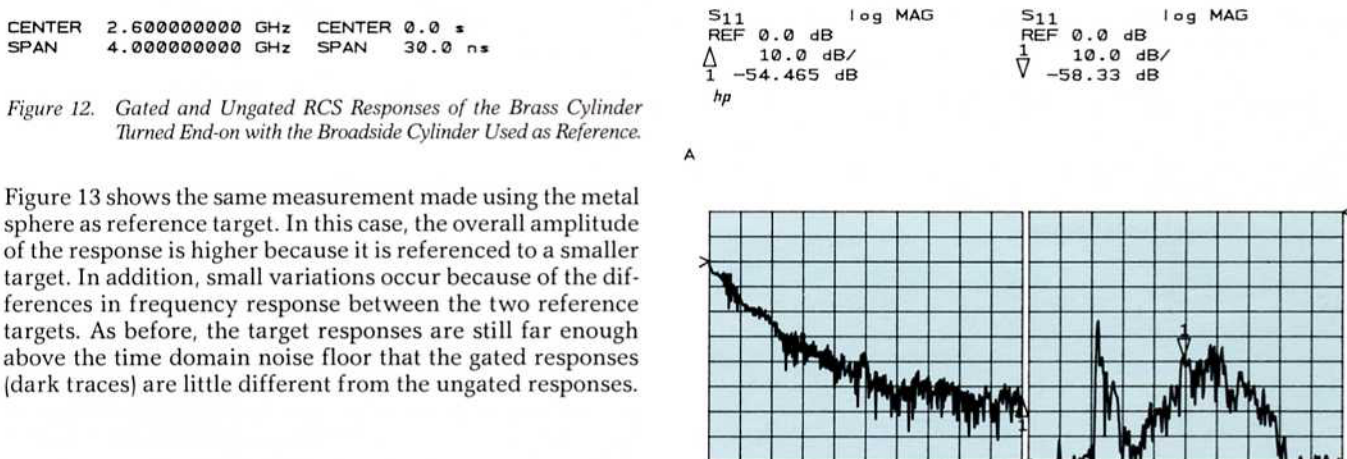

Figure 14. Uncorrected RCS Frequency and Time Domain Responses of a Styrofoam Target.

Figure 15 shows the calibrated responses of the styrofoam column (using the broadside cylinder as reference). With correction applied, the time domain response of the styrofoam target is 46 dB below the measured response of the reference target and yet still more than 30 dB above the measurement noise floor. This illustrates the dynamic range available with the HP 8510 measurement system in the RCS configuration.

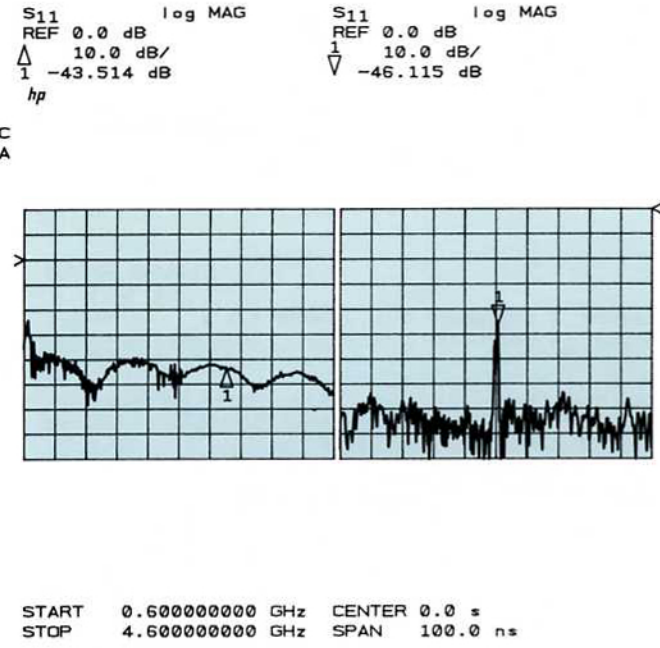

Figure 15. Calibrated RCS Frequency and Time Domain Responses of the Styrofoam Target.

A closer look at the time domain response of the styrofoam column, Figure 16, reveals that there are actually two reflections that occur, one from the front surface of the column and one from the back. The second response is actually larger than the first. This is due to the curvature of the column and how it reflects back the energy, and it shows how the time domain response can provide insight into the RCS responses of a target. In this low reflection case, the effects of gating (the dark traces) are more pronounced in reducing the effects of residual reflections and measurement noise.

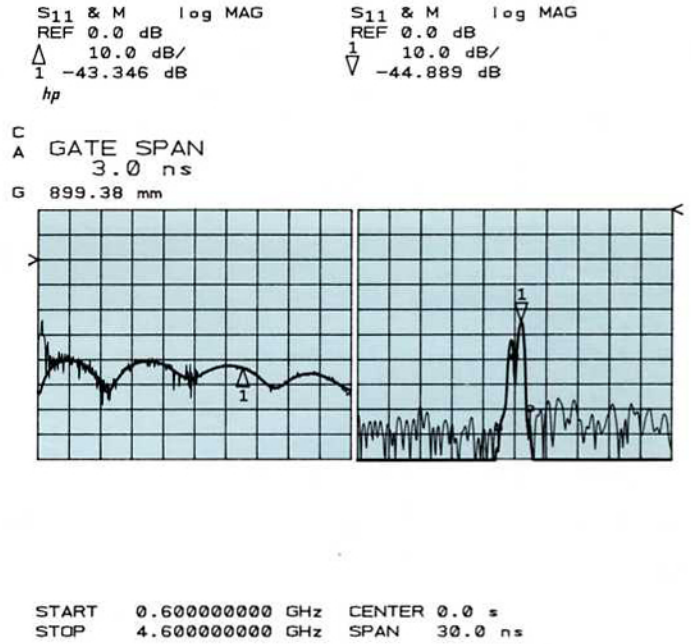

Figure 16. Gated RCS Frequency and Time Domain Responses of the Styrofoam Target.

HP 8510 RCS Configuration with Other Test Sets

Although the HP 8511A is the preferred test set for a dedicated RCS system (Figure 1), any of the HP 8510 test sets can be configured to make RCS measurements. The RCS configuration using the HP 8512A and HP 8513A reflection/transmission test sets or the HP 8514A and HP 8515A s-parameter test sets is shown in Figure 17. (This configuration, however, has approximately 20 dB less dynamic range than that of Figure 1.) The signal from port 1 of the test set is sent to the transmit antenna. The signal from the receive antenna is measured at port 2. In this configuration, the HP 8510 is set to display S_{21} , which gives the ratio of the received to the transmitted signal. To use the 1-port RCS calibration procedure with this measurement configuration, the parameter S_{11} is selected and the redefine parameter feature used to change S_{11} to display the ratio b_2/a_1 (normally b_1/a_1).

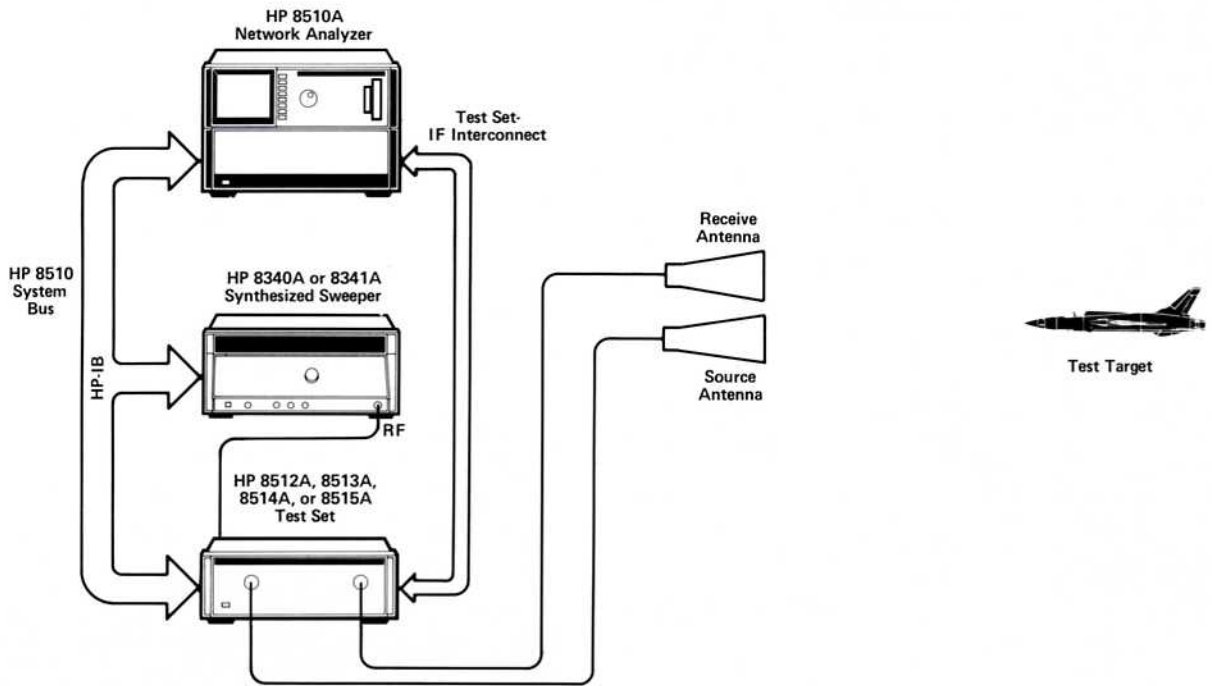

Figure 17. RCS Measurement Configuration Using the HP 8510 Network Analyzer with the HP 8512A, 8513A, 8514A, or 8515A Test Sets.

RCS Calibration Using the 2-Port Model

With the measurement configuration of Figure 17, it is also possible to use the internal 2-port error model of the HP 8510 to perform the required RCS error correction. This model has the advantage of not requiring an external controller to construct the calibration set. The one-path 2-port model is shown in Figure 18.

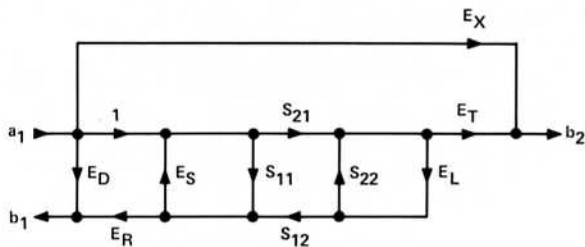

Figure 18. HP 8510 One-Path 2-Port Error Model for Forward Transmission.

Using the error model of Figure 18 is complicated in conception but simple in implementation. Proceeding from left to right, the three error terms E_D , E_R , and E_S are directivity, reflection tracking, and source match, respectively, associated with the 1-port return loss measurement. The terms E_X (isolation) and E_T (transmission tracking) are associated with the forward transmission. Term E_L is the load match. The error terms of most interest in this case are E_X (isolation), which is used to characterize the empty room, and E_T (tracking), which is used to characterize the response of the reference target.

For the full 2-port calibration, there is an additional mirror image error model for the reverse reflection and transmission error terms. This model can be used only with the HP 8514A and HP 8515A test sets (as configured in Figure 17).

The 2-port RCS calibration procedure is similar to the 2-port technique used to calibrate the HP 8510 for network measurements. The HP 8510 is set to display S_{21} . For the one-path 2-port model, an open-short-load reflection calibration must be performed at the end of the cable that connects the transmit antenna (at both antennas for the full 2-port model). This should be done before making the isolation and through measurements to avoid disturbing the anechoic chamber. The next step is to make all transmission measurements in the 2-port calibration sequence with the reference target in place. Finally, all isolation measurements are made of the room with the reference target removed.

Although the 2-port calibration technique has the advantage of not requiring an external controller, the technique also has some disadvantages. First, it requires making reflection measurements, used in the error model to compute the corrected S_{21} response, although they may not be meaningful in RCS measurements. Also, two to four sweeps are required per measurement, which slows down the trace update time. Finally, this technique does not allow the use of a power amplifier after the test set to increase the transmit power (and measurement dynamic range). The 1-port RCS calibration procedure does not have these limitations with either measurement configuration (Figures 1 or 17).

Comparison of Calibration Techniques

The 2-port RCS calibration technique (broadside cylinder as reference) was used to measure the responses of the brass cylinder turned at a 45 degree angle, shown in Figure 19. The dark traces represent the results after gating around the responses of the target. Figure 20 shows the same data measured using the 1-port RCS calibration procedure. This measurement has lower residual responses and less noise than occurs with the 2-port RCS calibration procedure. However, after gating is applied (the dark traces of Figures 19 and 20), there is very little difference between the two measurements. This shows that although the recommended method is to use the 1-port RCS calibration procedure, the 2-port technique will give similar results.

S_{21} & M	log MAG	S_{21} & M	log MAG
REF	0.0 dB	REF	0.0 dB
Δ	10.0 dB/	\downarrow	10.0 dB/
1	-20.357 dB	∇	-24.247 dB
hp			

C GATE SPAN
A 5.5 ns
G 1.6489 m



START 0.600000000 GHz CENTER 0.0 s
STOP 4.600000000 GHz SPAN 30.0 ns

Figure 19. Calibrated RCS Frequency and Time Domain Responses of the Brass Cylinder Turned 45° Using the 2-Port RCS Calibration Procedure.

S_{11} & M	log MAG	S_{11} & M	log MAG
REF	0.0 dB	REF	0.0 dB
Δ	10.0 dB/	\downarrow	10.0 dB/
1	-20.563 dB	∇	-24.199 dB
hp			

C GATE SPAN
A 5.5 ns
G 1.6489 m

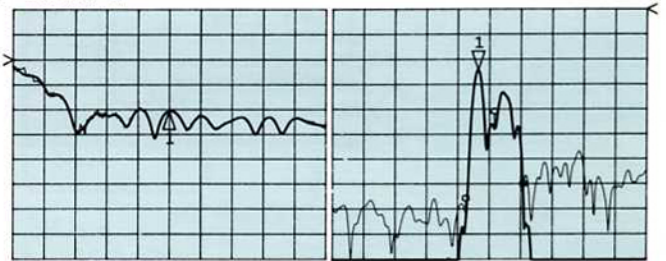

START 0.600000000 GHz CENTER 0.0 s
STOP 4.600000000 GHz SPAN 30.0 ns

Figure 20. Calibrated RCS Frequency and Time Domain Responses of the Brass Cylinder Turned 45° Using the 1-Port RCS Calibration Procedure.

Summary

The HP 8510 can easily be configured to make basic swept frequency RCS measurements with little or no external software requirements. The proper application of the built-in 1-port or 2-port calibration models allows making error corrected RCS measurements in the frequency and time domains at a speed that is essentially real-time in the ramp sweep mode. The time domain measurement capability of the HP 8510 can provide great insight into the RCS response of a target, and if the 1-port or 2-port RCS calibration procedures are used, the time domain gating and trace math features can be used to analyze individual portions of the corrected RCS responses and further reduce the effects of unwanted reflections and noise. The large dynamic range of HP 8510 in the RCS measurement configuration allows a wide range of radar cross-sections to be measured.

References

1. HP 8510 Network Analyzer Operating and Programming Manual, Hewlett-Packard Company, Santa Rosa, Ca., 1984.

```

10 ! FILENAME: RCS
20 !
30 ! This program is designed to be used with the HP 8510 network
40 ! analyzer to provide a RESPONSE-ISOLATION calibration for use
50 ! in radar cross-section measurements.
60 !
70 ! ATTENTION: This is undocumented, unsupported software. It has
80 ! not passed HP standard QA tests. No claim is made as
90 ! to the capability, accuracy, completeness, or suit-
100 ! ability for purpose. Assistance in applying or using
110 ! this software may be available at current consulting
120 ! rates.
130 !
140 OPTION BASE 1
150 ASSIGN @Nwa TO 716
160 ASSIGN @Nwa_data2 TO 716;FORMAT OFF
170 INTEGER Preamble,Size,No_points,Cals
180 !
190 DIM Room(401,2),Reference(401,2),Source(401,2) ! For different number
200 No_points=401 ! of points, change to
210 ! 51, 101, or 201.
220 !
230 DISP CHR$(129)&"MEASURE ROOM,"&CHR$(128)&" THEN PRESS CONTINUE"
240 LOCAL 716 ! Measure the empty room.
250 PAUSE ! This gives the Ed error
260 OUTPUT @Nwa;"FORM3;OUTPRAW1" ! term (isolation).
270 ENTER @Nwa_data2;Preamble,Size,Room(*) !
280 !
290 !
300 DISP CHR$(129)&"MEASURE REFERENCE,"&CHR$(128)&" THEN PRESS CONTINUE"
310 LOCAL 716 ! Measure the reference
320 PAUSE ! target. This is used
330 OUTPUT @Nwa;"FORM3;OUTPRAW1" ! to determine the response
340 ENTER @Nwa_data2;Preamble,Size,Reference(*) ! error term, Er.
350 !
360 !
370 DISP CHR$(131)&"SUBTRACTING OUT"&CHR$(128)&" THE EFFECTS OF THE ROOM."
380 FOR M=1 TO 2 ! This removes the
390 FOR N=1 TO No_points ! reflections from
400 Reference(N,M)=Reference(N,M)-Room(N,M) ! the target pedestal
410 NEXT N ! and walls and the
420 NEXT M ! coupling between
430 ! the antennas.
440 !
450 ! Because no value was assigned since dimensioning, the Es matrix
460 ! (Source(*)) is zero.
470 !
480 INPUT "ENTER CAL SET NUMBER (1-8) AND PRESS CONTINUE",Cals
490 IF Cals=0 THEN GOTO 480
500 DISP CHR$(131)&"LOADING"&CHR$(128)&" CAL COEFFICIENTS"
510 OUTPUT @Nwa;"CAL1;CALIS111"
520 OUTPUT @Nwa;"FORM3;INPUCALCO1" ! E_DIRECTIVITY
530 OUTPUT @Nwa_data2;Preamble,Size,Room(*)
540 OUTPUT @Nwa;"FORM3;INPUCALCO2" ! E_SOURCE_MATCH
550 OUTPUT @Nwa_data2;Preamble,Size,Source(*)
560 OUTPUT @Nwa;"FORM3;INPUCALCO3" ! E_RESPONSE
570 OUTPUT @Nwa_data2;Preamble,Size,Reference(*)
580 OUTPUT @Nwa;"SAVC;CALs"&VAL$(Cals)
590 DISP
600 LOCAL 716
610 END

```

For information about Hewlett-Packard products and services, telephone the local Hewlett-Packard sales and support office listed in your telephone directory. Or write to the appropriate address listed below.

U.S.A.

Hewlett-Packard
4 Choke Cherry Road
Rockville, MD 20850

Hewlett-Packard
5201 Tollview Drive
Rolling Meadows, IL 60008

Hewlett-Packard
2000 South Park Place
Atlanta, GA 30339

Hewlett-Packard
5161 Lankershim Blvd.
North Hollywood, CA 91601

Canada

Hewlett-Packard (Canada) Ltd.
6877 Goreway Drive
Mississauga, Ontario L4V 1M8
Tel: (416) 678-9430

United Kingdom

Hewlett-Packard Ltd.
King Street Lane
Winnersh, Wokingham
Berkshire RG11 5AR
Tel: 734/78 47 74

France

Hewlett-Packard France
Parc d'activités du Bois Briard
2, avenue du Lac
91040 Evry Cedex
Tel: 1 60 77 83 83

German Federal Republic

Hewlett-Packard GmbH
Hewlett-Packard-Strasse
Postfach 1641
D-6380 Bad Homburg
West Germany
Tel: 06172/400-0

Italy

Hewlett-Packard Italiana S.p.A.
Via G. Di Vittorio 9
I-20063 Cernusco Sul
Naviglio (Milano)
Tel: 02/92 36 91

Benelux and Scandinavia

Hewlett-Packard S.A.
Uilenstede 475
P.O. Box 999
NL-1183 AG Amstelveen
The Netherlands
Tel: (31) 20/43 77 71

Mediterranean and Middle East

Hewlett-Packard S.A.
Mediterranean and Middle East
Operations
Atrina Centre
32 Kifissias Avenue
Paradissos-Amarousion, Athens
Greece
Tel: (30) 682 88 11

South and East Europe, Africa

Hewlett-Packard S.A.
7, rue du Bois-du-Lan
CH-1217 Meyrin 2, Geneva
Switzerland
Tel: (41) 22/83 12 12

Japan

Yokogawa-Hewlett-Packard Ltd.
29-21 Takaido-Higashi, 3 Chome
Suginami-ku, Tokyo 168
Tel: 03 (331) 6111

Asia

Hewlett-Packard Asia Ltd.
47/F, 26 Harbour Road,
Wanchai, Hong Kong
G.P.O. Box 863, Hong Kong
Tel: (852) 5-8330833

Australasia

Hewlett-Packard Australia Ltd.
31-41 Joseph Street
Blackburn, Victoria 3130
Australia
Tel: (61) 895-2895

Other International Areas

Hewlett-Packard
Intercontinental Headquarters
3495 Deer Creek Road
Palo Alto, CA 94304

Corporate Headquarters
Hewlett-Packard
3000 Hanover Street
Palo Alto, CA 94304

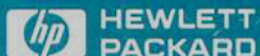

July 1, 1987

Printed in U.S.A.
5954-1522