

# Agilent PN 8780A-2

## Modulation Solutions for RF and Microwave Receiver Test

Product Note

### The Agilent 8780A—Off-the-Shelf “Real World” Modulation

Today’s advanced telemetry, terrestrial and satellite communications receivers vastly exceed the modulation capabilities of traditional narrow-band analog modulation signal generators. Testing these advanced receivers often requires custom-built test systems which include complicated combinations of splitters, filters and hybrid components.

The Agilent Technologies 8780A Vector Signal Generator is Agilent’s answer to the custom-built modulator for receiver test. It combines several highly-advanced modulators in a single programmable test instrument. Capable of AM, FM, Phase Modulation, and I/Q and Digital Modulations, the 8780A not only replaces most custom-built modulators over the 10 MHz to 3 GHz IF frequency range, but improves performance as well. And, unlike custom-built solutions, the vector signal generator has all the conveniences of a state-of-the-art synthesizer: programmable level and frequency plus automatic calibration at the touch of a button.

This note describes the modulation capabilities of the 8780A in detail. It also includes several actual measurements made on an 8780A sampled at random to show how actual performance compares with the specifications. In most cases, there is considerable margin in the specifications. Hopefully, by presenting actual measured data, you will be able to better determine if the 8780A is suitable for your applications. If you have to have a tighter specification, please contact your Field Engineer for a quote of a special option.

**NOW WITH  
PHASE  
MODULATION!**

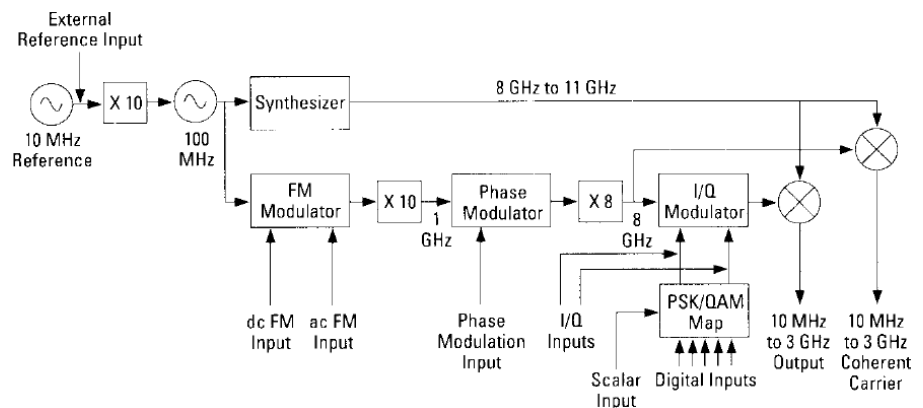
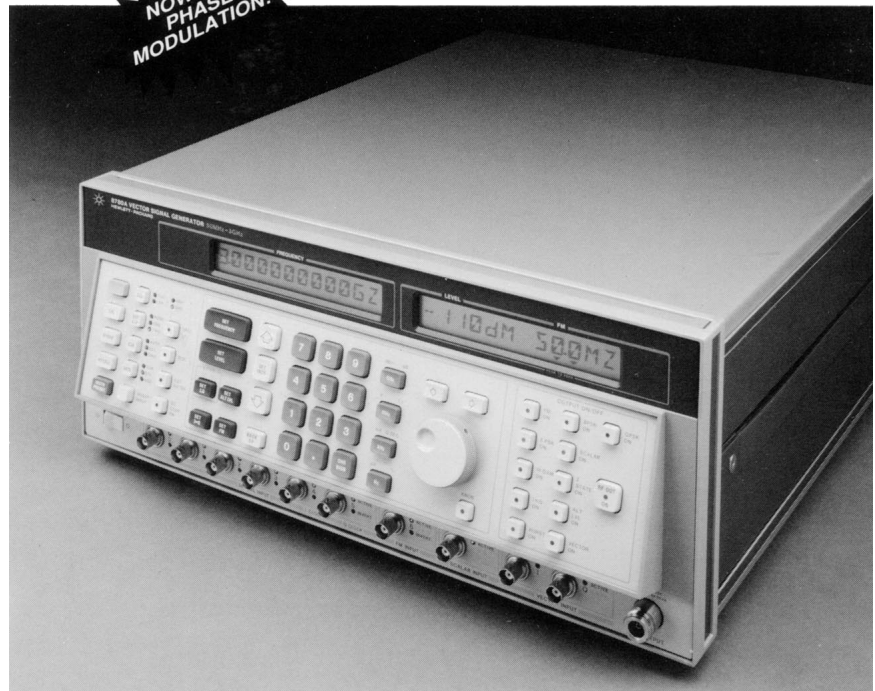

**Figure 1. Simplified 8780A Vector Signal Generator block diagram showing modulators and frequency mixing**



**Agilent Technologies**

Innovating the HP Way

**New! Phase Modulation >10 MHz BW, <10% THD, >3 Radians P-P Deviation**

In response to the needs of telemetry customers, we've added phase modulation to the 8780 as special option H02. Because the vector signal generator's phase modulator is placed in the multiplied LO path, very low distortion and wide deviations and rates are possible. This capability is especially valuable in the simulation of satellite or range telemetry signals. Not only does the 8780A generate telemetry signals, but it also generates the digital modulations used to carry data on satellite communications systems, and likely to carry tomorrow's telemetry information as well.

Figure 2 shows one phase modulator's frequency response. Although the bandwidth is specified to 10 MHz, this specification, like many on the 8780A, is conservative. As the graph shows, the measured response is flat to within tenths of a dB to 10 MHz and isn't down 3 dB until more than 80 MHz.

Phase modulation distortion is also conservatively specified at 10%. Figure 3 shows measured distortion less than 1% for rates to 10 MHz and peak-to-peak deviations less than the specified maximum 1.5 radians. Even if the modulator is over-driven by a factor of two, total harmonic distortion remains well below the 10% specification. Only at higher rates (eg. 20 MHz) does the distortion approach the specification, and then only when driven at very large deviations.

**Frequency Modulation >12 MHz BW, >50 MHz P-P Deviation**

The FM modulator of the vector signal generator also benefits from its location in the 8780A's multiplier chain. Not only are very wide peak-to-peak deviations and rates possible, but distortion is also very low.

FM modulation is available as narrowband DC FM or wideband AC FM. The narrowband mode has lower phase noise. Narrow band DC FM is specified for up to 10 kHz BW and 150 kHz peak-to-peak deviations. The wideband AC FM is specified for up to 12 MHz BW and 50 MHz peak-to-peak deviations. A special function is also available to extend peak-to-peak DC FM deviations to >200 MHz, but rates remain limited to the 10 kHz input bandwidth.

Where extremely wide deviations and input bandwidths are required, the 8780A FM modulator may be driven directly by rerouting two internal connectorized cables (remove cable from A7J6 and reconnect at A6J10). In this configuration, the input bandwidth is >12 MHz and peak-to-peak deviations of >250 MHz are possible; however, this is basically an open loop VCO input and performance is much less stable than other operating modes.

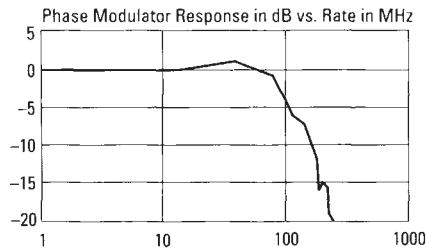

**Figure 2. Phase modulator frequency response**

One of the most demanding applications for an FM modulator is the generation of video signals. The vector signal generator's AC FM is designed with this challenge in mind. Differential gain and phase are specified at less than 2% and 1 degree respectively for 27.6 MHz peak-to-peak deviations.

Another very demanding application for an FM modulator is the generation of CHIRP radar signals. The CHIRP graphs demonstrate the dynamic performance of the vector signal generator's FM modulator, showing in a single signal very high peak-to-peak frequency deviation, linearity, and input bandwidth.

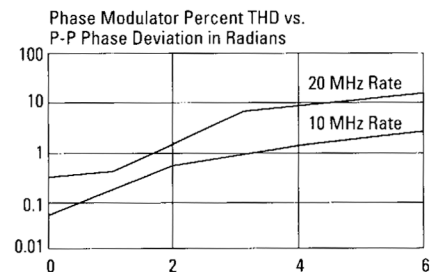

**Figure 3. Phase modulator distortion**

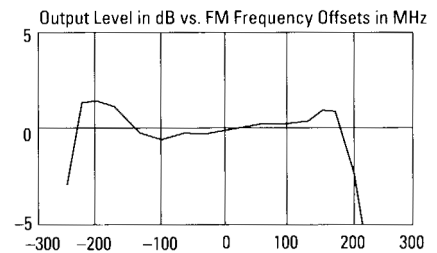

**Figure 4. Maximum FM deviation possible without exceeding 8780A internal IF filter BWs**

## Vector Modulation >350 MHz BW <1% Error

Many modern transmitters and receivers use vector or “I/Q” Modulation to encode digital signals or to completely analyze received signals in terms of phase and magnitude. The vector signal generator is ready to test these receivers too. By operating at a fixed frequency, the generator’s I/Q modulator provides very accurate modulation with almost no quadrature error and amplitude imbalance. The heterodyne output section downconverts the signal to the generator’s 10 MHz to 3 GHz output. The result is calibrated I/Q modulation over more than 8 octaves of range—something impossible using custom-built modulators which employ direct modulation techniques.

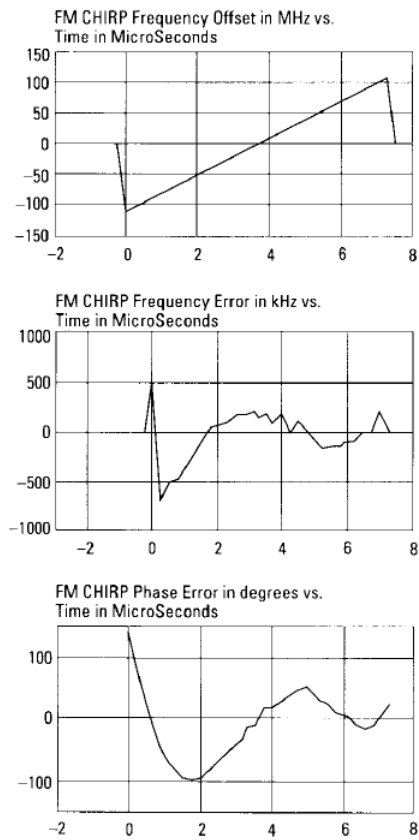

Figure 5, 6, 7. Very wide deviation CHIRP pulse performance illustrates exceptional FM performance

Other direct benefits of using a fixed frequency microwave I/Q modulator are in bandwidth, flatness, and group delay. Since the modulator operates at 8 GHz, the modulation frequencies common in communications and radar systems (10 to 100 MHz) cover very small fractional bandwidths. The result is extremely clean generation of relatively low bandwidth signals (see phase modulation section) and very wide bandwidth capability for I/Q modulation. The I and Q inputs on the 8780A are specified for bandwidths in excess of 350 MHz, but as the measurement of one 8780A below shows, the actual 3 dB bandwidth is often in excess of 500 MHz. This is particularly important where the I/Q inputs may be used to generate very high rate digital modulations (eg. QPSK) for testing advanced satellite communications modems.

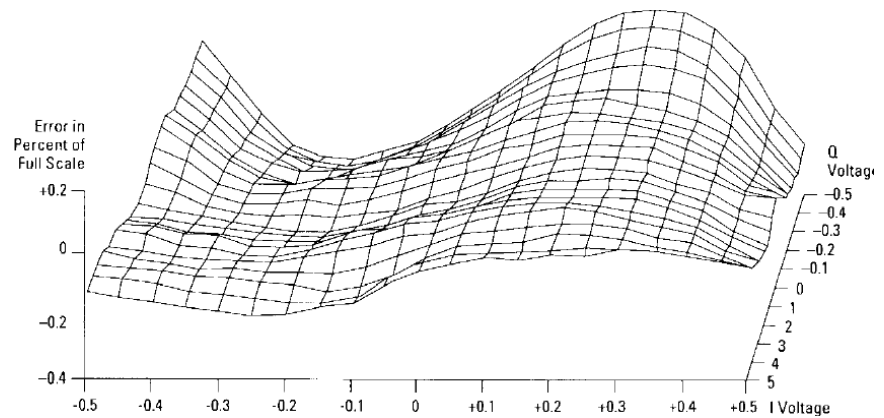

Figure 8. I/Q error versus I and Q drive voltages for all possible input values—no measured errors exceed 0.26%

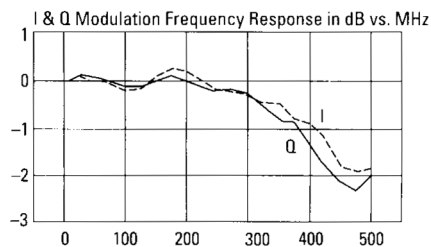

Figure 9. Vector modulation frequency response

## Digital Modulation

Most digital modulations can be easily generated using Agilent 8780A Vector Signal Generator digital inputs directly. The generator supports BPSK, QPSK, 8PSK, 16QAM, and 64QAM (with Option 64) with symbol rates up to 150 MHz covering most satellite and terrestrial communications applications.

Digital modulation accuracy of the generator is specified in maximum percent error as a percent of full scale output (the magnitude of the largest signal state). I/Q errors are specified to be less than 1% for BPSK and QPSK, less than 1.2% for 8PSK and less than 2% for 16QAM. In fact, measured error data is usually much better, as the sample of 16QAM constellation errors plotted below shows. Maximum error for any of the 16 states was 0.5%—much lower than the 2% specification.

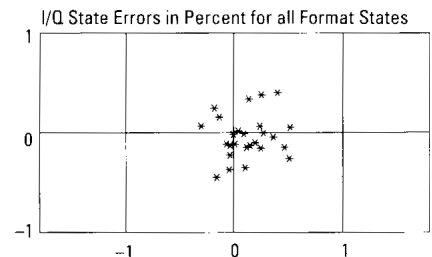

Figure 10. Digital modulation errors for all digital states in an 8780A—none measured exceed 0.5%

## Putting it All Together

The 8780A Vector Signal Generator's modulations are individually unsurpassed, and together provide unique solutions for receiver test. All of the generator's modulations are available simultaneously except digital and vector modulations which work simultaneously with all other modulations except each other. The ability to simulate multiple modulations simultaneously adds to the generator's versatility, by allowing receiver margin testing and accommodating receivers designed to work with multiple simultaneous modulations.

## Modulation Sources

With all of its bandwidth, you may be wondering where you get signals to drive a modulator like the 8780A. One excellent place is your own baseband circuits. Proprietary filtering, shaping, and coding are often done at baseband. By using your own baseband signals, you can be sure the signal generated by the 8780A will be "understood" by your receiver.

When your own baseband signals are inconvenient, or you want to eliminate potential baseband errors which might degrade the generated modulation, Agilent has a wide range of function and waveform generators which can generate calibrated baseband signals. An especially important product to mention is the 8770A Arbitrary Waveform Synthesizer (AWS). The AWS generates arbitrary signals with up to 50 MHz bandwidth ideal for driving any of the vector signal generator's analog inputs.

## Ordering Information

<b>8780A</b>	Vector Signal Generator
Opt. 064	adds 64QAM
Opt. H02	adds phase modulation
Opt. 001	adds +10 dBm coherent carrier (normally -20 dBm)
Opt. H05	adds 8 GHz CW output (typically 0 to -4 dBm)
<b>8770A</b>	Arbitrary Waveform Synthesizer

## Agilent Technologies' Test and Measurement Support, Services, and Assistance

Agilent Technologies aims to maximize the value you receive, while minimizing your risk and problems. We strive to ensure that you get the test and measurement capabilities you paid for and obtain the support you need. Our extensive support resources and services can help you choose the right Agilent products for your applications and apply them successfully. Every instrument and system we sell has a global warranty. Support is available for at least five years beyond the production life of the product. Two concepts underlie Agilent's overall support policy: "Our Promise" and "Your Advantage."

### Our Promise

"Our Promise" means your Agilent test and measurement equipment will meet its advertised performance and functionality. When you are choosing new equipment, we will help you with product information, including realistic performance specifications and practical recommendations from experienced test engineers. When you use Agilent equipment, we can verify that it works properly, help with product operation, and provide basic measurement assistance for the use of specified capabilities, at no extra cost upon request. Many self-help tools are available.

### Your Advantage

"Your Advantage" means that Agilent offers a wide range of additional expert test and measurement services, which you can purchase according to your unique technical and business needs. Solve problems efficiently and gain a competitive edge by contracting with us for calibration, extra-cost upgrades, out-of-warranty repairs, and on-site education and training, as well as design, system integration, project management, and other professional services. Experienced Agilent engineers and technicians worldwide can help you maximize your productivity, optimize the return on investment of your Agilent instruments and systems, and obtain dependable measurement accuracy for the life of those products.

**Get assistance with all your test and measurement needs at:**  
[www.agilent.com/find/assist](http://www.agilent.com/find/assist)

Product specifications and descriptions in this document subject to change without notice.

Copyright © 1990, 2000 Agilent Technologies  
Printed in U.S.A. 10/00  
5952-1416



**Agilent Technologies**

Innovating the HP Way