

8564EC-11A

S E R V I C E N O T E

Supersedes:
8564EC-11

8560EC Series Portable Spectrum Analyzers

Serial Numbers: ALL

LCD Assembly Lower Level Part Numbers

Parts Required:

P/N	Description	Qty.
NONE		

ADMINISTRATIVE INFORMATION

SERVICE NOTE CLASSIFICATION:	
INFORMATION ONLY	
<input type="checkbox"/> Calibration Required	PRODUCT LINE: 12
<input checked="" type="checkbox"/> Calibration NOT Required	AUTHOR: MPM
ADDITIONAL INFORMATION:	

© AGILENT TECHNOLOGIES, INC. 2013
PRINTED IN U.S.A.

December 10, 2013
Rev. 21



Situation:

The 08563-60170 replacement assembly has been widely used when the LCD panel needed to be replaced. However, this assembly now includes two lower level parts that are in a Life-Time Buy (LTB) status. Since only one of these two parts would typically be needed for a repair the replacement assembly has been discontinued so that both LTB parts would not be consumed when only one would be needed.

Solution/Action:

When a replacement LCD is required, instead of ordering the 08563-60170 assembly, order only the lower level part listed below that is required.

Item #	Description	Part #
1	Glass LCD Filter	1000-1014
2	Rubber LCD Mount	5041-9632
3	LCD Panel	2090-1042

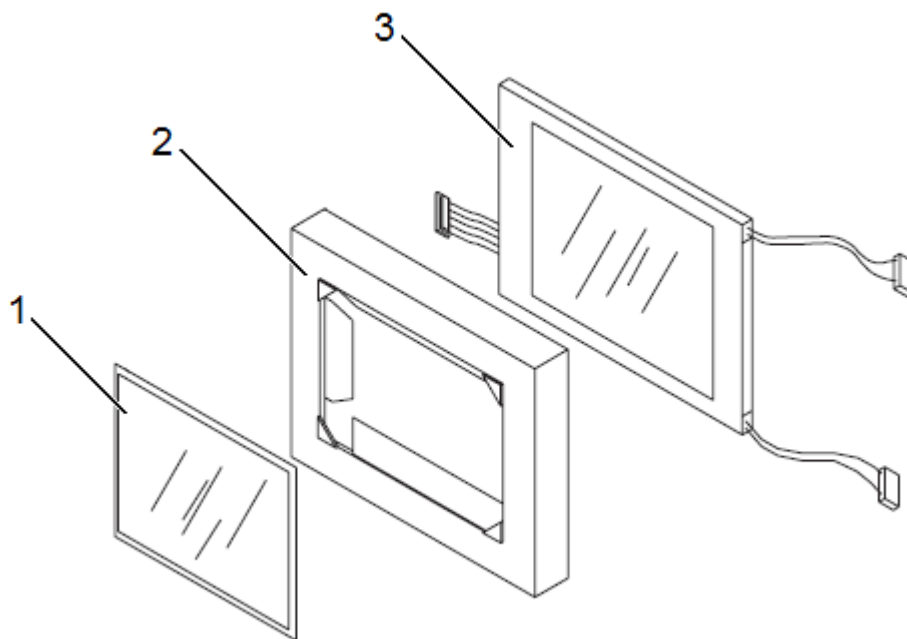
**Revision History:**

Revision Number	Date	Author	Reason For Change
1.0	10/09/2013	Mike Medley	As published
1.1	12/10/2013	Mike Medley	Updated LCD part number to LTB part